

# PRODUCT CATALOG

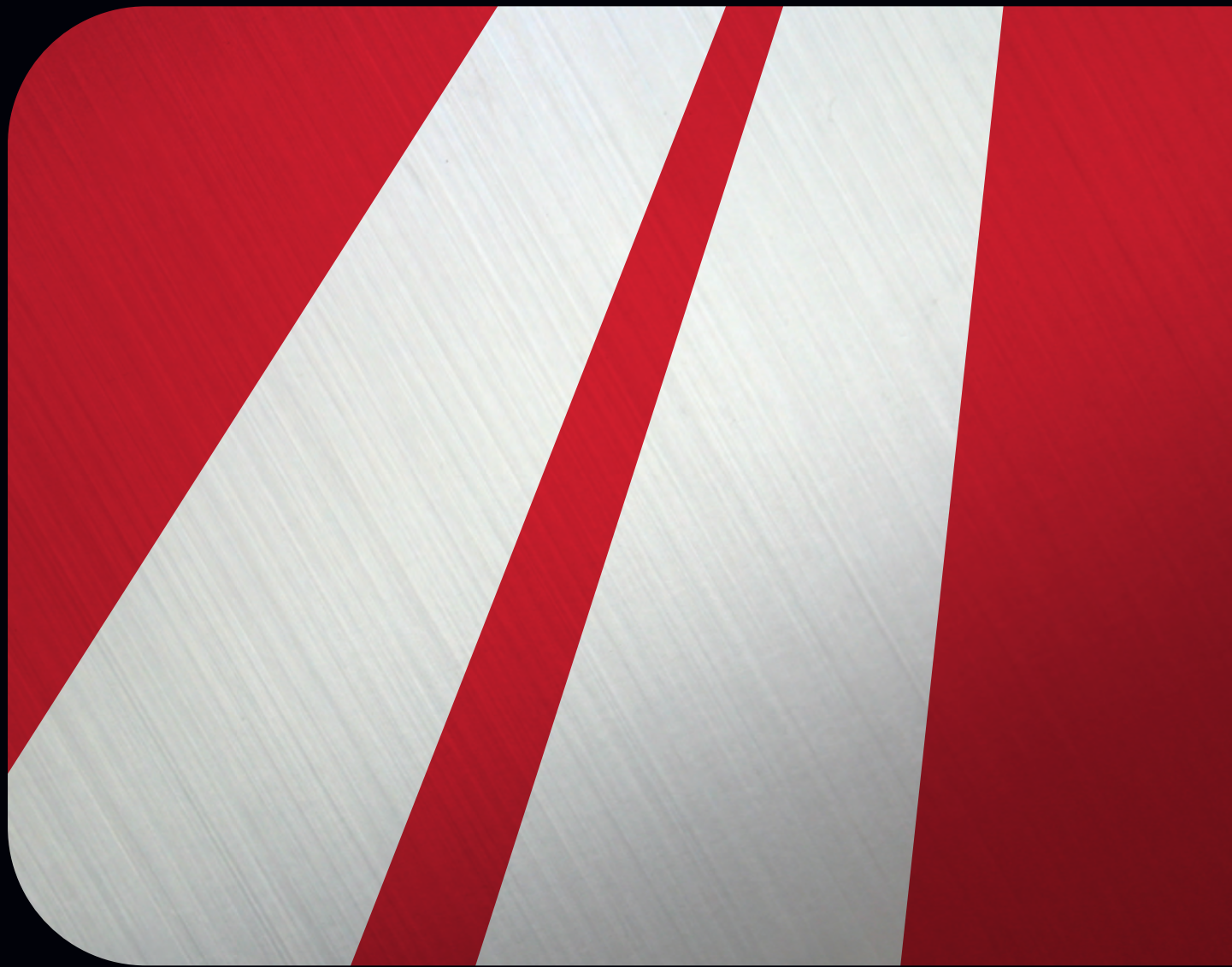

 **VELVAC**<sup>®</sup>  
*In the Passing Lane Since 1934*

## QUALITY DRIVEN COMPONENTS SINCE 1934



### WHATEVER YOU DRIVE, WE'VE GOT YOU COVERED.

Velvac products support a wide range of medium and heavy duty commercial vehicles, from Class 8 over the road haulers to RVs, buses, fire trucks, ambulances, walk-in vans, refuse and fleet vehicles.

Our mission is to improve driver safety and well being by offering superior products and solutions that fully satisfy our customers needs, making us better, faster and easier to do business with.

Our ability to design and produce cost effective, differentiated vision systems and components to automotive quality and appearance levels sets us apart from other companies in the industry, keeping us... *in the passing lane.*

### HELPFUL HINTS

*Throughout this catalog, there are many useful tips and tricks to assist you in selecting the right products for your vehicle, as well as ensuring that you're compliant with important specifications and regulations.*

**NOTE: Part numbers listed in RED are NEW!**

### THE VELVAC STORY

The Vacuum Power Equipment Company opened for business in 1934, beginning a long tradition of quality manufacturing and focused customer service. In 1940 the corporate name was changed to "Velvac" to encompass its popular *Velvet Vacuum Brakes* brand. Today, our product line has expanded considerably to over 4,500 vehicle components.

As a leading supplier to the heavy truck aftermarket, medium and heavy duty truck OEMs, recreational vehicle and specialty vehicle markets, Velvac continually upgrades and expands its operations. Consistently improving our quality systems helps us exceed our customers' expectations while developing and manufacturing innovative new products that remain in front of an ever-changing market place.

We strive to make doing business with us easy. Experienced, friendly customer and technical solutions personnel team up with knowledgeable sales staff to answer questions and simplify your ordering process. Our B2B website allows customers access to account information 24/7, including order tracking details and order upload capabilities. EDI, data file transfers, advanced ship notices and a host of other services round out the technological support Velvac provides to meet a wide variety of customer requirements.

Velvac is a TS 16949 and ISO 14001 certified, multi-national company with corporate offices and primary warehouse in New Berlin, Wisconsin and a full-line manufacturing and assembly facility in Reynosa, Mexico. Well-stocked remote warehouses strategically located in California, Texas and Ontario, Canada ensure fast delivery of popular items anywhere in North America.



New Berlin headquarters



Reynosa facility

- Founded in 1934
- Leading supplier of heavy truck aftermarket products
- TS 16949 & ISO 14001 certified
- LIKE us on Facebook   
[facebook.com/velvacinc](https://facebook.com/velvacinc)



Call the Velvac Sales Team: **800.783.8871** [sales@velvac.com](mailto:sales@velvac.com)

## TABLE OF CONTENTS

### MIRRORS

|                                |          |
|--------------------------------|----------|
| All Makes                      | M2-30    |
| West Coast                     | M2-10    |
| Convex Mirrors                 | M11-13   |
| Convex Mirror Heads            | M14-17   |
| Mirror Accessories             | M18-19   |
| Wide Angle Mirrors             | M20-21   |
| Class A, RV, Bus & Truck       | M22-23   |
| Hood Mount Mirrors             | M24-28   |
| Rear Cross View Mirrors        | M28-29   |
| Van & Cab Chassis Mirrors      | M30      |
| Truck & Tractor Mirrors        | M31      |
| Caterpillar                    | M32      |
| E-One                          | M33-34   |
| Ferrara                        | M35-36   |
| Ford                           | M37-50   |
| Freightliner                   | M51-60   |
| GM                             | M61-67   |
| GMC                            | M68      |
| Hino                           | M68-71   |
| HME                            | M72-73   |
| International                  | M74-103  |
| Kenworth                       | M103     |
| KME                            | M104-107 |
| Peterbilt                      | M108     |
| Pierce                         | M109-112 |
| Seagrave                       | M113-116 |
| Spartan                        | M117-118 |
| Sprinter                       | M119     |
| Sutphen                        | M120-121 |
| USPS                           | M122     |
| Volvo                          | M123-125 |
| Western Star                   | M125     |
| 2020 Mirror Replacement Parts  | M126-127 |
| Brackets, Clamps & Accessories | M128-130 |

### VISION SYSTEMS

|                       |        |
|-----------------------|--------|
| Camera Systems        | V2     |
| Cameras               | V3-5   |
| Monitors              | V6-7   |
| Cables                | V7     |
| Camera Kits           | V8-10  |
| 5th Wheel Dual Camera | V11    |
| AeroCam Vision System | V12-13 |
| Road-iQ Vision System | V14-16 |

### HOSE SUPPORT

|                                  |      |
|----------------------------------|------|
| Hose & Cable Support Accessories | H2-3 |
| Pogo Sticks                      | H3-4 |

### AIR PRODUCTS

|                                    |        |
|------------------------------------|--------|
| Gladhands                          | A2-4   |
| Air Brake Hose & Tubing            | A5-7   |
| Air/Electrical Assemblies          | A7     |
| Coiled Nylon Tubing                | A8     |
| Glacier Air Lines                  | A9     |
| Air Brake Hose & Tubing            | A10    |
| Air Brake Valves                   | A11-17 |
| Air Accessory Valves               | A17-23 |
| Pressure Switches & Indicators     | A24    |
| Air Tank Accessories               | A25-26 |
| Tanks, Brake Chambers & Diaphragms | A27    |
| Air Cylinder Control Valves        | A28-29 |
| Air Cylinders                      | A29-31 |
| Air Cylinder Tailgate Lock Kits    | A32    |
| Lift Axel & Suspension Valves      | A33-34 |

### ELECTRICAL PRODUCTS

|                                   |        |
|-----------------------------------|--------|
| Cable & Plug Assemblies           | E2     |
| 7-Way Coiled Cable Assemblies     | E3     |
| Electrical Plugs                  | E4     |
| Plug Adapters & Accessories       | E5     |
| Electrical Sockets & Accessories  | E6-7   |
| Electrical Cable                  | E8     |
| Battery Cable                     | E9     |
| Battery Lugs                      | E10    |
| Battery Terminals                 | E11-13 |
| Switches & Solenoids              | E14-18 |
| Relays                            | E18    |
| Signal Flashers                   | E19    |
| Circuit Breakers                  | E20    |
| Fuses & Accessories               | E21-23 |
| Terminals & Connectors            | E24-30 |
| Primary Wire & Accessories        | E31-32 |
| Heat-Shrink Tubing                | E33-35 |
| Tie Straps, Grommets & Wire Clips | E35-36 |
| Shop Tools & Accessories          | E37-38 |

### FITTINGS & HARDWARE

|                                    |         |
|------------------------------------|---------|
| Push-Lock Air Brake Fittings       | FH2-4   |
| Brass Push-Lock Air Brake Fittings | FH4-5   |
| Nylon Air Brake Tube Fittings      | FH5-7   |
| Air Brake Compression Fittings     | FH7-8   |
| Re-usable Air Hose Fittings        | FH8-9   |
| Clamping Studs                     | FH10    |
| Discharge Hose Fittings            | FH10    |
| Fuller Trans. Compression Fittings | FH11    |
| Inverted Flare Fittings            | FH11    |
| Pipe Fittings                      | FH12-13 |
| SAE 45° Fittings                   | FH14-15 |
| Truck & Trailer Repair Kits        | FH15-16 |
| Fitting Assortments                | FH17-18 |
| Hose Clamps & Coolant Valves       | FH19-23 |
| Clevis & Clevis Pins               | FH24-25 |

### FUEL SYSTEMS

|                                    |      |
|------------------------------------|------|
| Aluminum Non-Locking Fuel Caps     | F2-3 |
| Gas/Diesel Fuel Caps               | F4   |
| Replacement Parts for Caps         | F5   |
| Anti-Siphon Tubes                  | F5   |
| Fuel Tank Valves                   | F6   |
| Return Flow Splitters              | F6   |
| Diesel Fuel Valves                 | F6   |
| Electric Fuel Tank Selector Valves | F7   |
| Fuel Tank Safety Vents             | F7   |
| Fuel Tank Valves                   | F8   |
| Adapter Kits                       | F8   |

### BACK-UP ALARMS

|                                  |    |
|----------------------------------|----|
| Horn Style Alarms                | B2 |
| Speaker Style Alarms             | B3 |
| Back-up Alarms & Warning Devices | B4 |

### ACCESSORIES

|                    |       |
|--------------------|-------|
| Wiper Blades       | AC2-3 |
| Tarp Straps        | AC3   |
| Emergency Triangle | AC4   |
| King Pin Lock      | AC4   |
| Mechanics Wire     | AC4   |
| Document Holders   | AC5   |
| Radiator Caps      | AC6-7 |
| Conspicuity Tape   | AC7   |

### RETAIL MERCHANDISING

|                             |      |
|-----------------------------|------|
| Displays with Product       |      |
| Assortments                 | R2-4 |
| Fittings Display Racks      | R5-6 |
| Bucket & Counter Boxes      | R6-7 |
| Hose Clamp & Air Hose Racks | R7-8 |
| Floor Displays              | R9   |

### INDEX

|               |       |
|---------------|-------|
| Index Section | X1-19 |
|---------------|-------|

#### NOTE:

The information and photographs in this catalog are believed to be accurate and factual as of the print date. Velvac assumes no responsibility for information that may be incorrect or has changed since press time. Product specifications and offerings subject to change without notice.

**SMARTER. SAFER. CONNECTED.**

## Road-iQ



### Blind Spot Detection

Change lanes confidently with a camera-based alert system, notifying you of objects in your blind spots.



### 360° Active Safety

Increase driver awareness to help prevent accidents through up to 7 real-time camera views on a tablet or monitor.



### Vehicle Recording

Continuously record all of your trucks' cameras for easy viewing and sharing on an iPad.



### Remote Video Access

Live stream your vehicle cameras from anywhere, via your Road-iQ Fleet Management Portal.



### Vehicle Diagnostics

Specific fault descriptions alert driver and fleet managers of potential vehicle problems.

Visit  
**road-iq.com**  
for more info

**Safer  
Smarter  
Connected**



See V14 for more info on the Road-iQ System



Call the Velvac Sales Team: **800.783.8871** [sales@velvac.com](mailto:sales@velvac.com)

© VELVAC INC. • 2405 South Calhoun Road • New Berlin, WI 53151-2709 • Toll Free: 800.783.8871 • Fax: 262.786.4101

**OUR PARTS PUT YOU IN THE PASSING LANE**

# MIRRORS

## **See clearly.**

A combination of quality, styling and performance make Velvac mirrors the benchmark for medium and heavy duty commercial, recreational and specialty vehicles. Our mirrors reduce blind spots and provide clear views of passing lanes, making you a safer, more efficient driver.

- **West coast and mini-LEM mirrors**
- **Blind spot, accessory, chassis mirrors**
- **OEM replacement mirrors**



## ALL MAKES

### West Coast Mirrors

- Velvac's 2010 west coast mirror offers the widest viewing area available!
- Larger glass 2010 mirrors feature over 106 square inch viewing area
- Designed to fit any standard 17½" span loop
- Replaceable ⅛" FSC mirror glass
- 4 amp, temperature-controlled heating element provides quick, even defrosting and prevents mirror glass from overheating
- Polished 300 series stainless steel outer shell and heavy-duty ABS plastic inner housing combine to ensure durability and good looks
- Optional marker light provides additional safety by indicating the widest point of the vehicle to oncoming drivers
- Mounting hardware included



- Remote models also include a momentary motor switch

### Remote 2010 Mirror Features

- Heavy-duty, 1.5 RPM motor for fast, smooth adjustments
- Sealed motor housing for protection against moisture and contaminants
- Automatic slip clutch for manual adjustments without gear damage
- Interchangeable wire harness allows for convenient retrofitting



### Mirrors with 10' Wire Harness and Heater Switch

| Left Part # | Right Part # | M/R    | Heat | Light |
|-------------|--------------|--------|------|-------|
| 708209      | 708210       | Manual | •    | -     |
| 708211      | 708212       | Remote | •    | -     |
| 708369      | 708368       | Remote | •    | •     |

### Mirrors without Harness or Switches

| Left Part # | Right Part # | M/R    | Heat |
|-------------|--------------|--------|------|
| 708209-4    | -            | Manual | •    |
| 708211-4    | 708212-4     | Remote | •    |

### Replacement Parts

| Part # | Description               |
|--------|---------------------------|
| 709309 | Heated glass w/ bezel     |
| 709329 | Motor                     |
| 747386 | Lighted heater switch     |
| 747387 | Momentary motor switch    |
| 747451 | 4 Conductor harness, 124" |



Call the Velvac Sales Team: **800.783.8871** sales@velvac.com



## 7" x 16" V-back Mirrors

- Popular V-back design available in three different versions to meet any requirement or price point
- Over 96 square inches of viewing area
- Comes as stainless steel or painted versions, all with 5/16" hardware



### Good

- Cost effective mirror for high replacement application
- Gasket surrounds silvered glass for durability and edge shock protection
- Glass not replaceable
- Standard painted finish
- Plated hardware
- Individually packaged in display box



### Better

- Cost effective version of OEM mirror
- Gasket surrounds silvered glass for durability and edge shock protection
- Front surface chrome glass used on heated mirrors
- Replaceable glass
- Housing is powder coated to meet OEM requirements
- Plated hardware
- Individually packaged in display box



### Best

- Popular replacement mirror for several OE applications
- HD support bands and gasket surround the front surface chrome glass for added strength and durability
- Replaceable glass
- Housing is powder coated to meet OEM requirements
- All stainless steel hardware
- Individually packaged

| Part # | Color           | Heat |
|--------|-----------------|------|
| 705114 | Black           | -    |
| 705115 | Black           | •    |
| 705116 | White           | -    |
| 705112 | Stainless steel | -    |
| 705113 | Stainless steel | •    |

| Part # | Color           | Heat |
|--------|-----------------|------|
| 708001 | Black           | -    |
| 708005 | Stainless steel | -    |
| 708008 | Stainless steel | •    |

| Part # | Color           | Heat |
|--------|-----------------|------|
| 708020 | White           | -    |
| 708022 | Stainless steel | -    |
| 708046 | Stainless steel | •    |

### Flat Glass Kit

| Part # | Heat |
|--------|------|
| 702044 | -    |
| 702045 | •    |

### Flat Glass Kit

| Part # | Heat |
|--------|------|
| 702042 | -    |
| 702047 | •    |

# MIRRORS

## ALL MAKES

### West Coast Mirrors

- Designed with 1/8" silvered glass and 5/16" - 18 plated hardware. Mounting fasteners are included
- All west coast mirrors are packaged in a display box except the economy angle back mirrors



Angle back round corner - full flat or split glass

Angle back square corner

### Angle Back - Round Corner

| Part # | Size     | Description            | Color           | Flat Glass / Convex Glass Area (in <sup>2</sup> ) |
|--------|----------|------------------------|-----------------|---------------------------------------------------|
| 705333 | 7" x 16" | Standard glass         | Stainless steel | 93                                                |
| 705335 | 7" x 16" | Heated glass           | Stainless steel | 93                                                |
| 708331 | 7" x 16" | Heated w/ marker light | Stainless steel | 93                                                |
| 705334 | 7" x 16" | Split glass            | Stainless steel | 64 Flat / 36 Convex                               |

### Angle Back - Square Corner

| Part # | Size         | Description            | Color           | Flat Glass / Convex Glass Area (in <sup>2</sup> ) |
|--------|--------------|------------------------|-----------------|---------------------------------------------------|
| 708526 | 7" x 16"     | Standard glass         | Stainless steel | 99                                                |
| 708525 | 7" x 16"     | Heated glass           | Stainless steel | 99                                                |
| 705332 | 7" x 16"     | Heated w/ marker light | Stainless steel | 99                                                |
| 705108 | 6 1/2" x 16" | Heated w/ marker light | Stainless steel | 84                                                |

### Pillow Back

| Part # | Size         | Description    | Color           | Flat Glass / Convex Glass Area (in <sup>2</sup> ) |
|--------|--------------|----------------|-----------------|---------------------------------------------------|
| 705101 | 6 1/2" x 16" | Standard glass | Black           | 81                                                |
| 705102 | 6 1/2" x 16" | Standard glass | Stainless steel | 81                                                |
| 705103 | 6 1/2" x 16" | Standard glass | White           | 81                                                |



Call the Velvac Sales Team: **800.783.8871** [sales@velvac.com](mailto:sales@velvac.com)

© VELVAC INC. • 2405 South Calhoun Road • New Berlin, WI 53151-2709 • Toll Free: 800.783.8871 • Fax: 262.786.4101



#### Rib Back

| Part # | Size      | Description    | Color | Flat Glass / Convex Glass Area (in <sup>2</sup> ) |
|--------|-----------|----------------|-------|---------------------------------------------------|
| 705104 | 6½" x 16" | Standard glass | Black | 88                                                |
| 705117 | 6½" x 16" | Heated glass   | Black | 88                                                |
| 705105 | 6½" x 16" | Standard glass | White | 88                                                |

#### Aluminum Economy Angle Back

| Part #              | Size       | Description    | Color    | Flat Glass / Convex Glass Area (in <sup>2</sup> ) |
|---------------------|------------|----------------|----------|---------------------------------------------------|
| 705038 <sup>1</sup> | 6"w x 16"h | Standard glass | Aluminum | 94                                                |
| 705107 <sup>1</sup> | 6"w x 16"h | Split glass    | Aluminum | 66 Flat / 21 Convex                               |
| 705111 <sup>2</sup> | 6"w x 16"h | Standard glass | Aluminum | 94                                                |

#### NOTES

<sup>1</sup> Includes black plastic end caps

<sup>2</sup> Includes heavy duty metal end caps



*Pillow back*



*Rib back*

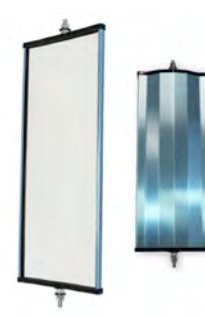

*Aluminum economy angle back - full flat or split glass*

# MIRRORS

## ALL MAKES

### West Coast Mirrors



Flat Glass Head



Flat Glass Kit

- 5/16-18 UNC Thread both ends

#### Head Size

7 $\frac{1}{4}$ "w x 15 $\frac{7}{8}$ "h x 3"d

#### Accessories

- **Maker Light Kit**

Model 421 | Part # V614210001

#### NOTES

**M/R** Manual / remote

#### Flat Glass Head Head adjustable

| Model | Part #     | Glass Size                | Side  | Color     | M/R    | Heat | Light |
|-------|------------|---------------------------|-------|-----------|--------|------|-------|
| 438   | V514380014 | 6 $\frac{7}{8}$ "w x 16"h | Right | Stainless | Remote | •    | •     |
| 438   | V514380013 | 6 $\frac{7}{8}$ "w x 16"h | Left  | Stainless | Remote | •    | •     |
| 438   | V514380012 | 6 $\frac{7}{8}$ "w x 16"h | Right | Stainless | Remote | •    | -     |
| 438   | V514380011 | 6 $\frac{7}{8}$ "w x 16"h | Left  | Stainless | Remote | •    | -     |
| 438   | V514380008 | 6 $\frac{7}{8}$ "w x 16"h | Right | Stainless | Manual | •    | •     |
| 438   | V514380007 | 6 $\frac{7}{8}$ "w x 16"h | Left  | Stainless | Manual | •    | •     |
| 438   | V514380006 | 6 $\frac{7}{8}$ "w x 16"h | Right | Stainless | Manual | •    | -     |
| 438   | V514380005 | 6 $\frac{7}{8}$ "w x 16"h | Left  | Stainless | Manual | •    | -     |
| 438   | V514380004 | 6 $\frac{7}{8}$ "w x 16"h | Right | Stainless | Manual | -    | •     |
| 438   | V514380003 | 6 $\frac{7}{8}$ "w x 16"h | Left  | Stainless | Manual | -    | •     |
| 438   | V514380001 | 6 $\frac{7}{8}$ "w x 16"h | Both  | Stainless | Manual | -    | -     |

#### Flat Glass Kit

| Model | Part #     | Glass Size                | Side | Color | M/R    | Heat |
|-------|------------|---------------------------|------|-------|--------|------|
| 438   | V154382117 | 6 $\frac{7}{8}$ "w x 16"h | Both | Black | Remote | •    |



Call the Velvac Sales Team: **800.783.8871** [sales@velvac.com](mailto:sales@velvac.com)

© VELVAC INC. • 2405 South Calhoun Road • New Berlin, WI 53151-2709 • Toll Free: 800.783.8871 • Fax: 262.786.4101

### West Coast Mirrors



Actuator

Flat Glass Kit

- 1- 1 1/8" tube

#### Head Size

7 5/16" w x 16 3/8" h x 4 5/8" d

#### Accessories

- **CB Bracket Parts Kit**

Model 409 | Part # V614090029

- **Head Clamp & Screws Kit**

Model 405 | Part # V624059999

**Flat Glass Housing** Head adjustable. Order glass to make complete head

| Model | Part #     | Glass Size           | Side  | Color  | M/R    | Heat | Light |
|-------|------------|----------------------|-------|--------|--------|------|-------|
| 409   | V614090024 | 6 3/4" w x 15 7/8" h | Right | Chrome | Remote | •    | -     |
| 409   | V614090023 | 6 3/4" w x 15 7/8" h | Left  | Chrome | Remote | •    | -     |
| 409   | V614090022 | 6 3/4" w x 15 7/8" h | Both  | Chrome | Manual | •    | -     |
| 409   | V614090021 | 6 3/4" w x 15 7/8" h | Both  | Chrome | Manual | -    | -     |
| 409   | V614090033 | 6 3/4" w x 15 7/8" h | Right | Black  | Remote | •    | -     |
| 409   | V614090032 | 6 3/4" w x 15 7/8" h | Left  | Black  | Remote | •    | -     |
| 409   | V614090031 | 6 3/4" w x 15 7/8" h | Both  | Black  | Manual | •    | -     |
| 409   | V614090030 | 6 3/4" w x 15 7/8" h | Both  | Black  | Manual | -    | -     |
| 409   | V614090028 | 6 3/4" w x 15 7/8" h | Right | Gray   | Remote | •    | -     |
| 409   | V614090027 | 6 3/4" w x 15 7/8" h | Left  | Gray   | Remote | •    | -     |
| 409   | V614090026 | 6 3/4" w x 15 7/8" h | Both  | Gray   | Manual | •    | -     |
| 409   | V614090025 | 6 3/4" w x 15 7/8" h | Both  | Gray   | Manual | -    | -     |

#### Flat Glass Kit

| Model | Part #     | Glass Size           | Side | Color | M/R  | Heat |
|-------|------------|----------------------|------|-------|------|------|
| 383   | V153832107 | 6 3/4" w x 15 7/8" h | Both | Black | Both | •    |
| 383   | V153832003 | 6 3/4" w x 15 7/8" h | Both | Gray  | Both | •    |
| 383   | V153832000 | 6 3/4" w x 15 7/8" h | Both | Gray  | Both | -    |

#### Flat Mirror Actuators

| Model | Part #     | Side  |
|-------|------------|-------|
| 409   | V084090002 | Right |
| 409   | V084090001 | Left  |

#### NOTES

**M/R** Manual / remote

# MIRRORS

## ALL MAKES

### West Coast Mirrors



Flat Glass Head



Flat Glass Kit



Mirror Cover

- 1- 1 $\frac{1}{8}$ " tube

#### Head Size

8 $\frac{1}{16}$ "w x 15 $\frac{1}{16}$ "h x 5 $\frac{1}{4}$ "d

#### Accessories

- **Marker Light Kit w/ Bezel**  
Model 427 | Part # V114272001
- **Head Clamp & Screws Kit**  
Model 400 | Part # V614000010

#### NOTES

**M/R** Manual / remote

<sup>1</sup> Chrome backcover with black housing

<sup>2</sup> Chrome backcover with chrome housing

### Flat Glass Head *Glass adjustable*

| Model | Part #                  | Glass Size                               | Side  | Color  | M/R    | Heat | Light |
|-------|-------------------------|------------------------------------------|-------|--------|--------|------|-------|
| 427   | V514271108 <sup>1</sup> | 7 $\frac{1}{4}$ "w x 14 $\frac{1}{4}$ "h | Right | Chrome | Remote | •    | •     |
| 427   | V514271107 <sup>1</sup> | 7 $\frac{1}{4}$ "w x 14 $\frac{1}{4}$ "h | Left  | Chrome | Remote | •    | •     |
| 427   | V514271008 <sup>1</sup> | 7 $\frac{1}{4}$ "w x 14 $\frac{1}{4}$ "h | Right | Chrome | Manual | •    | •     |
| 427   | V514271007 <sup>1</sup> | 7 $\frac{1}{4}$ "w x 14 $\frac{1}{4}$ "h | Left  | Chrome | Manual | •    | •     |
| 427   | V514271006 <sup>1</sup> | 7 $\frac{1}{4}$ "w x 14 $\frac{1}{4}$ "h | Right | Chrome | Manual | -    | -     |
| 427   | V514271005 <sup>1</sup> | 7 $\frac{1}{4}$ "w x 14 $\frac{1}{4}$ "h | Left  | Chrome | Manual | -    | -     |
| 427   | V514270018 <sup>2</sup> | 7 $\frac{1}{4}$ "w x 14 $\frac{1}{4}$ "h | Right | Chrome | Remote | •    | •     |
| 427   | V514270017 <sup>2</sup> | 7 $\frac{1}{4}$ "w x 14 $\frac{1}{4}$ "h | Left  | Chrome | Remote | •    | •     |
| 427   | V514270016 <sup>2</sup> | 7 $\frac{1}{4}$ "w x 14 $\frac{1}{4}$ "h | Right | Chrome | Remote | •    | -     |
| 427   | V514270015 <sup>2</sup> | 7 $\frac{1}{4}$ "w x 14 $\frac{1}{4}$ "h | Left  | Chrome | Remote | •    | -     |
| 427   | V514270019 <sup>2</sup> | 7 $\frac{1}{4}$ "w x 14 $\frac{1}{4}$ "h | Both  | Chrome | Manual | -    | -     |
| 427   | V514270104              | 7 $\frac{1}{4}$ "w x 14 $\frac{1}{4}$ "h | Right | Black  | Remote | •    | •     |
| 427   | V514270103              | 7 $\frac{1}{4}$ "w x 14 $\frac{1}{4}$ "h | Left  | Black  | Remote | •    | •     |
| 427   | V514270122              | 7 $\frac{1}{4}$ "w x 14 $\frac{1}{4}$ "h | Right | Black  | Remote | •    | -     |
| 427   | V514270121              | 7 $\frac{1}{4}$ "w x 14 $\frac{1}{4}$ "h | Left  | Black  | Remote | •    | -     |
| 427   | V514270004              | 7 $\frac{1}{4}$ "w x 14 $\frac{1}{4}$ "h | Right | Black  | Manual | •    | •     |
| 427   | V514270003              | 7 $\frac{1}{4}$ "w x 14 $\frac{1}{4}$ "h | Left  | Black  | Manual | •    | •     |
| 427   | V514270014              | 7 $\frac{1}{4}$ "w x 14 $\frac{1}{4}$ "h | Right | Black  | Manual | •    | -     |
| 427   | V514270013              | 7 $\frac{1}{4}$ "w x 14 $\frac{1}{4}$ "h | Left  | Black  | Manual | •    | -     |
| 427   | V514270002              | 7 $\frac{1}{4}$ "w x 14 $\frac{1}{4}$ "h | Right | Black  | Manual | -    | -     |
| 427   | V514270001              | 7 $\frac{1}{4}$ "w x 14 $\frac{1}{4}$ "h | Left  | Black  | Manual | -    | -     |



Call the Velvac Sales Team: **800.783.8871** sales@velvac.com

© VELVAC INC. • 2405 South Calhoun Road • New Berlin, WI 53151-2709 • Toll Free: 800.783.8871 • Fax: 262.786.4101

#### Flat Glass Kit

| Model | Part #                  | Glass Size   | Side  | Color | M/R             | Heat |
|-------|-------------------------|--------------|-------|-------|-----------------|------|
| 427   | V154270011              | 7¼"w x 14¼"h | Both  | Black | Manual / Remote | •    |
| 427   | V154270010              | 7¼"w x 14¼"h | Both  | Black | Manual / Remote | -    |
| 427   | V614270004 <sup>3</sup> | 7¼"w x 14¼"h | Right | Black | Manual / Remote | •    |
| 427   | V614270005 <sup>3</sup> | 7¼"w x 14¼"h | Left  | Black | Manual / Remote | •    |
| 427   | V614270002 <sup>3</sup> | 7¼"w x 14¼"h | Right | Black | Manual / Remote | -    |
| 427   | V614270003 <sup>3</sup> | 7¼"w x 14¼"h | Left  | Black | Manual / Remote | -    |

#### Mirror Cover

| Model | Part #                     | Side | Color  | Light |
|-------|----------------------------|------|--------|-------|
| 427   | V134271009 <sup>4</sup>    | Both | Chrome | •     |
| 427   | V134271008                 | Both | Chrome | -     |
| 427   | V614271007 <sup>4, 5</sup> | Both | Chrome | •     |
| 427   | V134271001 <sup>4</sup>    | Both | Black  | •     |
| 427   | V134271000                 | Both | Black  | -     |
| 427   | V614270006 <sup>4, 5</sup> | Both | Black  | •     |

#### NOTES

<sup>3</sup> Includes housing

<sup>4</sup> Furnished with punched holes

<sup>5</sup> Kit furnished with marker light

#### Flat Mirror Actuator

| Model | Part #     | Side |
|-------|------------|------|
| 427   | V084270006 | Both |

## ALL MAKES

### West Coast Mirrors



Actuator

- Fits 1- 1 1/8" tube

#### Head Size

8 13/16" w x 19" h x 5 1/4" d

#### Accessories

- **Head Clamp & Screws Kit**

Model 400 | Part # V614000010

#### NOTES

<sup>1</sup> Furnished with heated flat and convex glass

<sup>2</sup> Flat glass only

**M/R** Manual / remote

#### Flat Mirror Actuator

| Model | Part #     | Side |
|-------|------------|------|
| 480   | V084803997 | Both |



Call the Velvac Sales Team: **800.783.8871** [sales@velvac.com](mailto:sales@velvac.com)

© VELVAC INC. • 2405 South Calhoun Road • New Berlin, WI 53151-2709 • Toll Free: 800.783.8871 • Fax: 262.786.4101



### Blind Spot Convex Mirrors

#### DuraBall® Convex

- Velvac's DuraBall® mirror and pivot system features a HD nylon inner and outer ball with stainless bolt and locking "L" bracket for easy mounting and operation
- Heavy gauge stainless steel or powder coated galvanized steel construction protects mirrors against corrosion
- Rolled edge on 5" and 8½" diameter mirrors - outer gasket on 6" diameter mirrors
- Available in popular 10", 8½", 6" and 5" diameters with several lens options. The 8½" is also available with center mount or offset mount
- DuraBall mirrors guaranteed against shell cracking and breaking for 5 years
- Mirrors other than wide view include mounting "L" bracket or tube bracket, mounting hardware and display box



5" diameter



8½" diameter



8½" diameter



Wide view  
8½" diameter



Wide view  
10" diameter

#### Three Screw and Specialty Convex Mirror

- Three screw ball stud offers secure mounting and easy adjustment
- Available in high luster stainless steel, chrome plated steel or painted steel finishes
- 8½", 7½", 6" and 5" diameters with standard convex and heated options. The 8½" and 7½" are also available either center mount or offset mount
- Includes mounting "L" bracket, mounting hardware and comes in a display box
- 708558 convex features high luster chrome plated stainless steel shell and heavy duty nylon ball stud; bracket not included



7½" diameter



7½" diameter



8½" diameter



8½" diameter  
chrome plated  
stainless

# MIRRORS

## ALL MAKES

### Blind Spot Convex Mirrors

Continued

| Description      | ROC |
|------------------|-----|
| 10" Wide view    | 8½" |
| 8½" Wide view    | 5½" |
| 6" DuraBall      | 14" |
| 5" DuraBall      | 10" |
| All other convex | 13" |

#### Helpful hint:

Mirror head diameter and ROC (radius of curvature) help determine field of view coverage and image size provided by the convex mirror. Wide view convex mirrors are typically used for front and rear cross view applications where a wide field of view is desired. Standard convex mirrors are used for viewing targeted blind spots or passing lanes around the vehicle



5" and 6" diameter

#### NOTES

<sup>1</sup> For heavy duty nylon ball stud see page M11

<sup>2</sup> Stainless steel tube bracket and clamp kit 723057 also shown on page M128

Plexiglas® is shatter resistant

DuraBall®, Eyeball® and K-10® are registered trademarks of Velvac, Inc. Plexiglas® is a registered trademark of Evonik Industries

| Description                                  | DuraBall Convex Lens |              |                     | Three Screw and Specialty Lens |              |
|----------------------------------------------|----------------------|--------------|---------------------|--------------------------------|--------------|
|                                              | Standard Glass       | Heated Glass | Wide View Convex    | Standard Glass                 | Heated Glass |
| <b>10" Center Mount</b>                      |                      |              |                     |                                |              |
| Stainless Steel                              | -                    | -            | 709218 (Plexiglas®) | -                              | -            |
| Black                                        | -                    | -            | 709216              | -                              | -            |
| White                                        | -                    | -            | 709217              | -                              | -            |
| Post Office White                            | -                    | -            | 709226              | -                              | -            |
| <b>8½" Center Mount</b>                      |                      |              |                     |                                |              |
| Stainless Steel                              | 708441               | 708453       | 708448              | 708501                         | 708559       |
| Black                                        | 708442               | -            | 708449              | 708503                         | -            |
| White                                        | -                    | -            | 708450              | -                              | -            |
| Post Office White                            | -                    | -            | 708463              | -                              | -            |
| Chrome                                       | -                    | -            | -                   | 708556                         | -            |
| Chrome Plated Stainless                      | -                    | -            | -                   | 708558 <sup>1</sup>            | -            |
| <b>8½" Offset Mount</b>                      |                      |              |                     |                                |              |
| Stainless Steel                              | 708444               | 708457       | -                   | 708502                         | 708560       |
| Black                                        | 708446               | -            | -                   | 708504                         | -            |
| Chrome                                       | -                    | -            | -                   | 708557                         | -            |
| <b>7½" Center Mount</b>                      |                      |              |                     |                                |              |
| Stainless Steel                              | -                    | -            | -                   | 708508                         | -            |
| Black                                        | -                    | -            | -                   | 708510                         | -            |
| Chrome                                       | -                    | -            | -                   | 708554                         | -            |
| <b>7½" Offset Mount</b>                      |                      |              |                     |                                |              |
| Stainless Steel                              | -                    | -            | -                   | 708509                         | -            |
| Black                                        | -                    | -            | -                   | 708511                         | -            |
| Chrome                                       | -                    | -            | -                   | 708555                         | -            |
| <b>6" Center Mount</b>                       |                      |              |                     |                                |              |
| Stainless Steel                              | 708478               | -            | -                   | 708515                         | -            |
| Stainless Steel w/ Tube Bracket <sup>2</sup> | 708476               | -            | -                   | -                              | -            |
| Black                                        | 708479               | -            | -                   | 708516                         | -            |
| Chrome                                       | -                    | -            | -                   | 708553                         | -            |
| <b>5" Center Mount</b>                       |                      |              |                     |                                |              |
| Stainless Steel                              | -                    | -            | -                   | 708520                         | -            |
| Stainless Steel - Flat Glass                 | 708473               | -            | -                   | 708514                         | -            |
| Black                                        | -                    | -            | -                   | 708521                         | -            |
| Black - Flat Glass                           | -                    | -            | -                   | 708513                         | -            |
| Chrome                                       | -                    | -            | -                   | 708552                         | -            |
| Chrome ABS                                   | -                    | -            | -                   | 708551                         | -            |



Call the Velvac Sales Team: **800.783.8871** sales@velvac.com

© VELVAC INC. • 2405 South Calhoun Road • New Berlin, WI 53151-2709 • Toll Free: 800.783.8871 • Fax: 262.786.4101



### Standard K-10 Convex Lens

#### Convex Glass Head

| Part # | Color                          | Diameter | ROC |
|--------|--------------------------------|----------|-----|
| 708602 | Stainless steel                | 10"      | 13" |
| 708615 | Black ABS                      | 10"      | 13" |
| 708601 | Stainless steel - center mount | 8.5"     | 13" |
| 708609 | Stainless steel - offset mount | 8.5"     | 13" |

#### Convex Glass Kit

| Part # | Diameter | ROC |
|--------|----------|-----|
| 702149 | 10"      | 13" |
| 702148 | 8.5"     | 13" |

### Eyeball Convex Lens

#### Convex Glass Head

| Part # | Color           | Diameter | ROC  |
|--------|-----------------|----------|------|
| 708605 | Stainless steel | 10"      | 8.5" |
| 708604 | Black ABS       | 10"      | 8.5" |
| 708608 | Stainless steel | 8.5"     | 5.5" |
| 708610 | Black ABS       | 8.5"     | 5.5" |
| 708606 | Black           | 8.5"     | 5.5" |
| 708603 | Black ABS       | 6"       | 5.5" |

#### Convex Glass Kit

| Part # | Diameter | ROC  |
|--------|----------|------|
| 702159 | 10"      | 8.5" |
| 702158 | 8.5"     | 5.5" |

### 8" Polypropylene Convex Mirrors

| Part # | Color             |
|--------|-------------------|
| 723103 | Post Office White |
| 723104 | Black             |

#### NOTES

For replaceable front crossview for USPS LLV and CRV, see page M122

### Blind Spot Convex Mirrors



Back view  
Eyeball convex

- Provides outstanding views of troublesome and dangerous blind spots around the vehicle
- Choose from 10", 8½" and 6" diameter in stainless steel, powder coat steel or ABS plastic with standard K-10 convex and Eyeball® convex lens options
- HD inner and outer nylon ball stud with stainless steel mounting hardware for durable, smooth and long lasting operation
- Use as a supplement to west coast mirrors, side blind spots or front and rear cross view applications
- Heavy duty outer gasket protects mirrors from edge shock and allows mirror lens to be easily replaced



8"  
Polypropylene  
convex mirror

- 12" radius of curvature
- Light weight one piece non-corrosive plastic shell
- Adjustable stud mount ball socket
- 5/16" mounting hardware included

# MIRRORS

## ALL MAKES

### Convex Mirror Heads



Convex Glass Kit



Convex Mirror Cover

- Fits 1- 1 $\frac{1}{8}$ " tube

#### Convex Head Size

8"w x 7 $\frac{1}{16}$ "h x 5 $\frac{3}{8}$ "d

#### Accessories

- **Head Clamp & Screws Kit**  
Model 400 | Part # V614000010

#### NOTES

**M/R** Manual / remote

### Convex Glass Housing Glass adjustable. Order glass to make complete head

| Model | Part #     | Glass Size                              | Side | Color | M/R    | Heat | Light |
|-------|------------|-----------------------------------------|------|-------|--------|------|-------|
| 458   | V144580001 | 7 $\frac{3}{4}$ "w x 7 $\frac{3}{8}$ "h | Both | Black | Manual | -    | -     |

### Convex Glass Kit

| Model | Part #     | Glass Size                              | Side | Color | M/R    | Heat |
|-------|------------|-----------------------------------------|------|-------|--------|------|
| 458   | V154580003 | 7 $\frac{3}{4}$ "w x 7 $\frac{3}{8}$ "h | Both | Black | Manual | -    |

### Convex Mirror Cover

| Model | Part #     | Side | Color | Light |
|-------|------------|------|-------|-------|
| 458   | V134580001 | Both | Black | -     |



- Fits  $\frac{9}{16}$  -  $\frac{3}{4}$ " tube

#### Convex Head Size

7 $\frac{7}{8}$ "w x 6 $\frac{1}{8}$ "h x 3 $\frac{3}{4}$ "d

#### NOTES

**M/R** Manual / remote

### Convex Glass Head Head adjustable

| Model | Part #     | Glass Size                              | Side | Color | M/R    | Heat | Light |
|-------|------------|-----------------------------------------|------|-------|--------|------|-------|
| 260   | V562601127 | 7 $\frac{1}{2}$ "w x 5 $\frac{5}{8}$ "h | Both | Black | Manual | -    | -     |



Call the Velvac Sales Team: **800.783.8871** [sales@velvac.com](mailto:sales@velvac.com)

© VELVAC INC. • 2405 South Calhoun Road • New Berlin, WI 53151-2709 • Toll Free: 800.783.8871 • Fax: 262.786.4101

**ALL MAKES**

## Convex Mirror Heads

- Fits 1- 1 1/8" tube

### Convex Head Size

7 1/4"w x 7 1/4"h x 3"d

### NOTES

**M/R** Manual / remote



*Convex Glass Head*

*Convex Glass Kit*

### Convex Glass Head *Head adjustable*

| Model | Part #     | Glass Size        | Side | Color  | M/R    | Heat | Light |
|-------|------------|-------------------|------|--------|--------|------|-------|
| 388   | V563882218 | 6 3/4"w x 6 3/4"h | Both | Chrome | Manual | •    | -     |
| 388   | V563882208 | 6 3/4"w x 6 3/4"h | Both | Chrome | Manual | -    | -     |

### Convex Glass Kit

| Model | Part #     | Glass Size        | Side | Color | M/R    | Heat |
|-------|------------|-------------------|------|-------|--------|------|
| 388   | V153882117 | 6 3/4"w x 6 3/4"h | Both | Black | Manual | •    |
| 388   | V153882213 | 6 3/4"w x 6 3/4"h | Both | Gray  | Manual | •    |

## ALL MAKES

### Convex Mirror Heads



Convex Glass Kit



Head Clamp & Screw Kit

- Fits 1- 1 1/8" tube

#### Convex Head Size

7 1/4" w x 7 1/4" h x 5 1/8" d

#### Accessories

- **Mirror Head Clamp**  
Model 387 | Part # V113870510B
- **Head Clamp & Screws Kit**  
Model 405 | Part # V624059999

#### NOTES

**M/R** Manual / remote

### Convex Glass Housing Head adjustable. Order glass to make complete head

| Model | Part #     | Glass Size          | Side | Color  | M/R    | Heat | Light |
|-------|------------|---------------------|------|--------|--------|------|-------|
| 409   | V614090018 | 6 3/4" w x 6 3/4" h | Both | Chrome | Manual | •    | -     |
| 409   | V614090017 | 6 3/4" w x 6 3/4" h | Both | Chrome | Manual | -    | -     |
| 409   | V614090035 | 6 3/4" w x 6 3/4" h | Both | Black  | Manual | •    | -     |
| 409   | V614090034 | 6 3/4" w x 6 3/4" h | Both | Black  | Manual | -    | -     |
| 409   | V614090020 | 6 3/4" w x 6 3/4" h | Both | Gray   | Manual | •    | -     |
| 409   | V614090019 | 6 3/4" w x 6 3/4" h | Both | Gray   | Manual | -    | -     |

### Convex Glass Kit

| Model | Part #     | Glass Size          | Side | Color | M/R    | Heat |
|-------|------------|---------------------|------|-------|--------|------|
| 388   | V153882117 | 6 3/4" w x 6 3/4" h | Both | Black | Manual | •    |
| 388   | V153882120 | 6 3/4" w x 6 3/4" h | Both | Black | Manual | -    |
| 388   | V153882213 | 6 3/4" w x 6 3/4" h | Both | Gray  | Manual | •    |
| 388   | V153882210 | 6 3/4" w x 6 3/4" h | Both | Gray  | Manual | -    |



Call the Velvac Sales Team: **800.783.8871** [sales@velvac.com](mailto:sales@velvac.com)

### Convex Mirror Heads



Convex Glass Head

Convex Mirror Cover

- Fits 1- 1 1/8" tube

#### Convex Head Size

8 7/16" w x 6 5/8" h x 4 1/2" d

#### Accessories

- **Head Clamp & Screws Kit**  
Model 400 | Part # V614000010

#### NOTES

**M/R** Manual / remote

<sup>1</sup> Chrome backcover with black housing

<sup>2</sup> Chrome backcover with chrome housing

<sup>3</sup> Furnished with turn signal

<sup>4</sup> Includes housing

### Convex Glass Head *Glass adjustable*

| Model | Part #                     | Glass Size          | Side | Color  | M/R    | Heat | Light |
|-------|----------------------------|---------------------|------|--------|--------|------|-------|
| 428   | V564281005 <sup>1</sup>    | 7 3/4" w x 5 3/4" h | Both | Chrome | Manual | -    | -     |
| 428   | V564281014 <sup>2</sup>    | 7 3/4" w x 5 3/4" h | Both | Chrome | Manual | •    | -     |
| 428   | V564281015 <sup>2, 3</sup> | 7 3/4" w x 5 3/4" h | Both | Chrome | Manual | •    | -     |
| 428   | V564281013 <sup>2</sup>    | 7 3/4" w x 5 3/4" h | Both | Chrome | Manual | -    | -     |
| 428   | V564281002                 | 7 3/4" w x 5 3/4" h | Both | Black  | Manual | •    | -     |
| 428   | V564281001                 | 7 3/4" w x 5 3/4" h | Both | Black  | Manual | -    | -     |

### Convex Glass Kit

| Model | Part #                  | Glass Size          | Side | Color | M/R    | Heat |
|-------|-------------------------|---------------------|------|-------|--------|------|
| 428   | V154280002              | 7 3/4" w x 5 3/4" h | Both | Black | Manual | •    |
| 428   | V154280003 <sup>3</sup> | 7 3/4" w x 5 3/4" h | Both | Black | Manual | •    |
| 428   | V154280001              | 7 3/4" w x 5 3/4" h | Both | Black | Manual | -    |
| 428   | V614280008 <sup>4</sup> | 7 3/4" w x 5 3/4" h | Both | Black | Manual | -    |

### Convex Mirror Cover

| Model | Part #     | Side | Color  | Light |
|-------|------------|------|--------|-------|
| 428   | V134281015 | Both | Chrome | -     |
| 428   | V134281011 | Both | Black  | -     |

# MIRRORS

## ALL MAKES

### Accessory Mirrors

#### Over Door Convex Mirror



- Mounts above exterior passenger side window for greater blind spot visibility
- Used as an accessory mirror on heavy trucks for better viewing directly below "peek-a-boo" window
- 4" x 8" convex mirror, 12" ROC
- Assembly includes stainless steel mirror head with mounting bracket

| Part # | Description             |
|--------|-------------------------|
| 715198 | Over door convex mirror |

#### Long Arm Over Door Convex Mirror



- Over 1" longer than standard over door mirrors
- All stainless steel construction and hardware

| Part # | Description             |
|--------|-------------------------|
| 716872 | Over door convex mirror |

#### Interior Rearview Mirror



- Glass measures 9"w x 2"h
- Day/night feature reduces night driving glare
- Dual ball joint adjustment
- Textured black housing
- Mounting pad and adhesive sold separately as mirror mounting kit
- Rear view mirror will fit on flange type mounting pads up to .90" wide

| Part # | Description         |
|--------|---------------------|
| 723095 | Rear view mirror    |
| 723097 | Mirror mounting kit |

#### Universal Strap-On/Off Mirror



- Universal design fits either driver or passenger side mirrors on most vehicles
- Durable black mirror quickly and securely straps to existing mirror for extended view around wide loads
- No tools required

| Part # | Description                                 |
|--------|---------------------------------------------|
| 715203 | Strap-on towing mirror 5" x 7½" mirror head |

The Wedge™ is a trademark of Velvac, Inc

#### 7½" X 10½" Center Bracket Flat Glass Mirror Heads



- Over 63 sq. in. viewing area
- ⅛" FSC glass
- Rolled edge design holds glass and gasket securely in place
- Mirror glass not replaceable

| Part # | Description        |
|--------|--------------------|
| 709002 | Stainless steel    |
| 709006 | Stainless / heated |
| 709275 | Flat black         |
| 709276 | White              |

#### HHR Spotter Mirror



- Reduce blind spots on GM HHR
- Mounts directly to OE side mirrors\*
- Lower portion of flat glass is open for passing lane viewing
- Size is approx 2½" x 3¼" with 7.3 sq. in. viewing area and 8½" ROC

| Part #   | Description              |
|----------|--------------------------|
| 718394-5 | Pair - right & left side |

\* Other applications include van, pickup and SUV mirrors



Call the Velvac Sales Team: **800.783.8871** sales@velvac.com

© VELVAC INC. • 2405 South Calhoun Road • New Berlin, WI 53151-2709 • Toll Free: 800.783.8871 • Fax: 262.786.4101

### Accessory Mirrors

#### The Wedge™ Stick-On Convex Mirror



- Unique wedge design provides more usable viewing area/larger image size than conventional stick on mirrors
- Universal design permits use on both driver and passenger mirrors
- Black plastic shell with rounded corners gives mirror a "built-in" look
- 3¼" overall size with 8½ ROC
- Mounts easily and securely using attached adhesive pad

| Part #   | Description           |
|----------|-----------------------|
| 723068   | Wedge stick-on mirror |
| 723068-6 | 50 Pack wedge mirror  |

#### Stick-On Convex Spot Mirrors



- Lightweight aluminum shell
- Mount easily and securely using attached adhesive pad
- Attractive packaging displays easily on pegboards or wire display racks (See Retail section for wire display rack Part No. 091256)

| Part # | Description        | ROC |
|--------|--------------------|-----|
| 723050 | 2" Round           | 4½" |
| 723060 | 3" Round           | 4½" |
| 723065 | 3¾" Round          | 4½" |
| 723075 | 4" x 5½" Rectangle | 8½" |

#### Convex Fork Lift Mirror



- Mirror used on many OEM fork lift applications
- 4½"w x 7½"h overall size
- Acrylic spherical convex lens provides wide view and resists cracking or breaking
- Durable black textured ABS mirror back with black PVC outer gasket
- ⅜" plated mounting stud, nut and washer
- Individually boxed

| Part # | Description             |
|--------|-------------------------|
| 708611 | Convex fork lift mirror |

#### Convex Look Down Mirror



Convex Glass Kit

#### Bracket Mount Convex Head Size

11⅜"w x 6⅞"h x 2⅞"d

**Bracket Hole Location**  
**Width Between Holes:** 3⅛"  
**Hole Size:** 1¼"

#### NOTES

**M/R** Manual / remote

<sup>1</sup> Furnished with black arm, chrome back cover, black bezel and black holder

<sup>2</sup> Furnished with black arm, black back cover, black bezel and black holder

<sup>3</sup> Includes bezel

#### Convex Look Down Mirror

| Model | Part #                  | Glass Size   | Color  | M/R    | Heat | Light |
|-------|-------------------------|--------------|--------|--------|------|-------|
| 360   | V593605228 <sup>1</sup> | 10⅝"w x 6¼"h | Chrome | Manual | -    | -     |
| 360   | V593601152 <sup>2</sup> | 10⅝"w x 6¼"h | Black  | Manual | -    | -     |

#### Convex Glass Kit

| Model | Part #                  | Glass Size   | Side | Color | M/R    | Heat |
|-------|-------------------------|--------------|------|-------|--------|------|
| 360   | V613600001 <sup>3</sup> | 10⅝"w x 6¼"h | Both | Black | Manual | -    |

## ALL MAKES

### Wide Angle Mirrors

#### Stud Mount Mirror Heads



- Center mount wide angle mirror heads feature Velvac's DuraBall nylon ball stud for superior strength and durability (see page M11 for DuraBall information)
- 5/16" - 18 mounting stud. Use with mounting clamp 704068 on page M131
- 1/8" replaceable FSC glass on flat glass models; 1/8" silvered glass on convex glass

#### 6 1/2" x 6" Convex Glass

- Viewing area 32 sq. in.
- 21" ROC



#### 6 1/2" x 10" Flat Glass

- Viewing area 55 sq. in.



#### Shatter Resistant 6 1/2" x 10" Convex Glass

- Viewing area 55 sq. in.
- 40" ROC; shatter resistant backing on glass



| Color      | 6 1/2" x 6" Convex Glass |         |          | 6 1/2" x 10" Flat Glass |         |          | Shatter Resistant 6 1/2" x 10" Convex Glass |          |          |
|------------|--------------------------|---------|----------|-------------------------|---------|----------|---------------------------------------------|----------|----------|
|            | Part #                   | Glass # | Gasket # | Part #                  | Glass # | Gasket # | Part #                                      | Glass #  | Gasket # |
| Stainless  | 708156                   | 702023  | 703006   | 708181                  | 702076  | 703008   | 708198-5                                    | 702098-5 | 703008   |
| White      | -                        | -       | -        | -                       | -       | -        | 708176-5                                    | 702098-5 | 703007   |
| Ford White | 704280                   | 702023  | 703005   | 704268                  | 702076  | 703007   | -                                           | -        | -        |
| Black      | -                        | -       | -        | -                       | -       | -        | 708197-5                                    | 702098-5 | 703008   |



Call the Velvac Sales Team: **800.783.8871** [sales@velvac.com](mailto:sales@velvac.com)



### Wide Angle Mirrors

#### Side Mount Angle Mirror Heads



#### 6½" x 6" Flat Glass

- Viewing area 32 sq. in.



#### 6½" x 6" Convex Glass

- Viewing area 32 sq. in.
- 21" ROC



- The original Velvac wide angle mirror head is used on walk-in van, cutaway van, cab chassis and a variety of other applications
- 5/16" - 18 threaded mounting port for a clean, easy installation. Use with mounting clamp 704068 on page M131
- 1/8" replaceable FSC glass on all flat glass models except UPS brown which is silvered. All convex glass is silvered glass

#### 6½" x 10" Flat Glass

- Viewing area 55 sq. in.

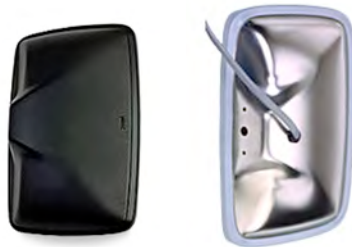

|                        | 6½" x 6" Flat Glass |         |          | 6½" x 10" Flat Glass |         |          | 6½" x 6" Convex |         |          |
|------------------------|---------------------|---------|----------|----------------------|---------|----------|-----------------|---------|----------|
| Color                  | Part #              | Glass # | Gasket # | Part #               | Glass # | Gasket # | Part #          | Glass # | Gasket # |
| <b>Steel</b>           |                     |         |          |                      |         |          |                 |         |          |
| Stainless              | 704093              | 702051  | 703005   | 704091               | 702076  | 703007   | 704095          | 702023  | 703005   |
| Stainless <sup>1</sup> | -                   | -       | -        | 704325               | 702076  | 703007   | 704315          | 704335  | 703005   |
| White                  | 704078              | 702051  | 703005   | 704032               | 702076  | 703007   | 704077          | 702023  | 703005   |
| <b>Plastic</b>         |                     |         |          |                      |         |          |                 |         |          |
| White                  | 704178-5            | 702051  | 703101   | 704132-5             | 702076  | 703102   | 704177-5        | 702057  | 703101   |
| PO White               | -                   | -       | -        | 704122               | 702076  | 703102   | 704120          | 704121  | 703101   |
| UPS Brown              | 704158              | 702051  | 703103   | 704154               | 702076  | 703104   | 704155          | 702057  | 703103   |
| Black                  | 704159              | -       | 703103   | 704152-5             | 702076  | 703104   | 704153-5        | 702057  | 703103   |

NOTES  
<sup>1</sup> Heated

# MIRRORS

## ALL MAKES

### Class A RV, Bus and Truck Mirrors

- Velvac's line of side mount and corner mount mirrors are designed with a focus on safety, quality and styling. Typical applications include Class A motorhomes, motorcoach, fire truck and rescue vehicles. Produced from high quality materials, these mirrors can be configured to meet specific customer and application requirements

#### Available Features/Options

- Deluxe, V-MAX™ or V-MAX III™ mirror heads
- Top Hat™ add-on convex for Deluxe head
- Chrome plated or powder coated finish

- Easily replaceable manual or heated remote glass
- Lower marker lamp on arm or signal arrow in the flat glass
- Lower LEM camera with LED marker lamp

#### Model 2025 Mirror System

- Mirror system mounts to the flat side of the vehicle, allowing the mirror to be viewed through the side window



Shown with Deluxe head

#### Revolution™ Mirror System

- Mirror base pivot system mounts to flat side of vehicle and allows mirror to be folded forward or back for vehicle storage



Shown with V-MAX™ head

#### Model 2030 Mirror System

- Corner mounting base available with 9", 10", 11", 12" or 15" radius. Contact Velvac for custom applications
- Mirror arm lengths available from 10", 12", 14" or 17". This allows mirrors to be viewed through the windshield or side windows



Shown with Deluxe head and add-on Top Hat™ convex

#### Top Hat Add-On Convex Mirror

| Part # | Color  |
|--------|--------|
| 715372 | Black  |
| 715373 | White  |
| 715374 | Chrome |

- Installs easily on top of Deluxe head for added visibility of blind spots or other vision targets
- Fits on either driver side or passenger side mirror



Deluxe Revolution™, V-Max™, V-MaxIII™ and Top Hat™ are trademarks of Velvac, Inc.

#### NOTES

Top Hat fits either driver side or passenger side  
All heads shown are heated remote flat glass

Camera not included with replacement LEM heads  
See RV make/model information at [www.velvac.com](http://www.velvac.com) by clicking Where to Buy / Order RV Mirrors



Call the Velvac Sales Team: **800.783.8871** [sales@velvac.com](mailto:sales@velvac.com)

© VELVAC INC. • 2405 South Calhoun Road • New Berlin, WI 53151-2709 • Toll Free: 800.783.8871 • Fax: 262.786.4101

**ALL MAKES**

## Class A RV, Bus and Truck Mirrors

### Mirror Heads



| Mirror Head | Flat Glass  |          | Lower Convex Glass |         |        | Upper Convex Glass |           |        |
|-------------|-------------|----------|--------------------|---------|--------|--------------------|-----------|--------|
|             | Square Inch | Size     | Square Inch        | Size    | Radius | Square Inch        | Size      | Radius |
| Deluxe      | 62.3        | 8" x 8"  | 30                 | 8" x 4" | 12"    | N/A                | N/A       | N/A    |
| V-MAX       | 98.7        | 8" x 13" | 30                 | 8" x 4" | 21"    | N/A                | N/A       | N/A    |
| V-MAX III   | 72.5        | 8" x 9"  | 30                 | 8" x 4" | 21"    | 26.4               | 8" x 3.3" | 21"    |
| Top Hat     | N/A         | N/A      | N/A                | N/A     | N/A    | 17.8               | 6" x 3.5" | 12.5"  |

### Mirror Heads

| Color  | Side  | Deluxe | V-MAX  | V-MAX III | V-MAX LEM | V-MAX LEM | V-MAX III LEM |
|--------|-------|--------|--------|-----------|-----------|-----------|---------------|
|        |       |        |        |           | 2025 Base | 2030 Base | 2030 Base     |
| White  | Right | 714590 | 714946 | -         | -         | -         | -             |
| White  | Left  | 714589 | 714947 | -         | -         | -         | -             |
| Black  | Right | 714582 | 714944 | 717192    | 716208    | 716190    | 716154        |
| Black  | Left  | 714581 | 714945 | 717193    | 716207    | 716189    | 716155        |
| Chrome | Right | 714608 | 714942 | 717180    | 716206    | 716188    | 716152        |
| Chrome | Left  | 714607 | 714943 | 717179    | 716205    | 716187    | 716153        |

### Glass Kits

| Description                 | Deluxe | V-MAX  | V-MAX III | V-MAX LEM | V-MAX LEM | V-MAX III LEM |
|-----------------------------|--------|--------|-----------|-----------|-----------|---------------|
|                             |        |        |           | 2025 Base | 2030 Base | 2030 Base     |
| Heated flat right or left   | 709448 | 709450 | 709732    | 709450    | 709450    | 709732        |
| Heated flat with blinker RS | 709674 | 709624 | 709702    | 709624    | 709624    | 709702        |
| Heated flat with blinker LS | 709673 | 709623 | 709701    | 709623    | 709623    | 709701        |
| Lower convex RS/LS          | 709449 | 709650 | 709650    | 709650    | 709650    | 709650        |
| Upper convex glass          | -      | -      | 709733    | -         | -         | 709733        |
| Lower convex housing RS/LS  | 709589 | 709651 | 709651    | 709651    | 709651    | 709651        |

#### NOTES

**RS** Right side

**LS** Left side

## ALL MAKES

### Hood Mount Mirrors

#### Velvac's Mod Pod™ and K-10 Version-2 Hood Mount Assemblies

**Helpful hint:**

The popular Velvac Mod Pod and K-10 Version-2 (V-2) mirror systems incorporate a lock down feature that offers superior stability and easy adjustments. To position the mirror, simply loosen the set screw with a 5/32" allen wrench, lift and rotate the mirror arm into proper viewing or fold back position then retighten the set screw. Precision gears set at 12 degree intervals ensures a perfect view every time!

- Aerodynamic design features corrosion resistant stainless steel tubing brackets with chrome-plated die cast mounting base for long lasting attractive appearance
- (4) 1/4" - 20 mounting studs are factory assembled to the base for easy installation on either conventional or COE trucks
- Velvac Mod Pod mirror kits features Velvac's 8 1/2" DuraBall with nylon ball joint system, guaranteed for five years against cracking or breaking (see page M11 and M12 for details)
- K-10 V-2 mirror kits feature an 8 1/2" Eyeball convex mirror (see page M13 for details)

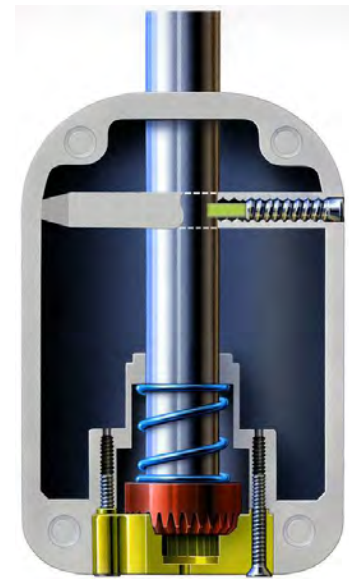

Mod Pod™ is a trademark of Velvac, Inc

|                               | Velvac         |                                 |                                    | K-10           |                                |                             |
|-------------------------------|----------------|---------------------------------|------------------------------------|----------------|--------------------------------|-----------------------------|
|                               | Bracket Only # | Kit w/ 8 1/2" DuraBall Convex # | Kit w/ 8 1/2" DuraBall Wide View # | Bracket Only # | Kit w/ 8 1/2" Eyeball Mirror # | Kit w/ 8 1/2" K-10 Convex # |
| <b>Universal Adjustable</b>   |                |                                 |                                    |                |                                |                             |
| Kit with Bent & Straight Arms | 714622         | 714620                          | 714621                             | -              | -                              | -                           |
| Kit with Straight Arm Only    | -              | -                               | -                                  | 714646         | -                              | -                           |
| Kit with Bent Arm Only        | -              | -                               | -                                  | 714647         | 716915                         | 716914                      |
| <b>Fixed Arm Dual View</b>    |                |                                 |                                    |                |                                |                             |
| Right Side                    | 714630         | 714626                          | 714628                             | 714648         | 716913                         | -                           |
| Left Side                     | 714631         | 714627                          | 714629                             | 715529         | 716922                         | -                           |
| <b>Fixed Arm Side View</b>    |                |                                 |                                    |                |                                |                             |
| Lane Change                   | 714625         | 714623                          | 714624                             | -              | -                              | -                           |
| K-10 Slant Arm                | -              | -                               | -                                  | 714649         | 716917                         | 716916                      |
| K-10 Angle Arm                | -              | -                               | -                                  | 715620         | 716919                         | 716918                      |



Bent arm



Straight arm



Fixed arm dual view



Lane change



Slant arm



Angle arm



Call the Velvac Sales Team: **800.783.8871** sales@velvac.com

### Hood Mount Mirrors

- Velvac offers a full line of standard and short arm adjustable tripod mirror models to meet the needs of any vehicle or application

#### Aero-Bell™ Tripod

- Stylized single piece chrome plated ABS bells and molded nylon clamps help conceal hardware, giving the mirror a clean, aerodynamic appearance
- Corrosion resistant materials eliminate rust

#### Velvac Tripod

- All stainless steel construction and hardware
- Standard tripod for use on traditional hood styles; use short tripod for slope nosed vehicles with shorter hoods

#### Value Tripod

- All stainless steel construction with plated hardware
- Adjustable tripod fits most hood / fender applications

|                    | Aero-Bell Tripod             | Velvac Tripod                | Value Tripod                    |
|--------------------|------------------------------|------------------------------|---------------------------------|
| Tubing Braces      | Stainless steel              | Stainless steel              | Stainless steel                 |
| Convex Mirror Head | 8½" Stainless steel DuraBall | 8½" Stainless steel DuraBall | 8½" Stainless steel three screw |
| Mounting Bells     | Molded/chrome plate ABS      | Stainless steel              | Stainless steel                 |
| Tube Clamps        | Molded black nylon           | Stainless steel              | Stainless steel                 |
| Hardware           | Stainless steel              | Stainless steel              | Plated                          |
| Packaging          | Display box                  | Display box                  | Plain box                       |

| Standard Tripod      | Aero-Bell Tripod |              | Velvac Tripod |              | Value Tripod |             |
|----------------------|------------------|--------------|---------------|--------------|--------------|-------------|
|                      | Part #           | Dim "A"      | Part #        | Dim "A"      | Part #       | Dim "A"     |
| Mirror & Bracket Kit | 715150           | 21" to 32¾"  | 713444        | 21" to 32¾"  | 715779       | 26" to 35"  |
| Bracket Only         | -                | -            | 713445        | -            | 715778       | -           |
| Short Tripod         |                  |              |               |              |              |             |
| Mirror & Bracket Kit | 715148           | 17½" to 24½" | 714721        | 17½" to 24½" | 717845       | 17½" to 26" |
| Bracket Only         | -                | -            | 714720        | -            | 717844       | -           |

Aero-Bell™ is a trademark of Velvac, Inc

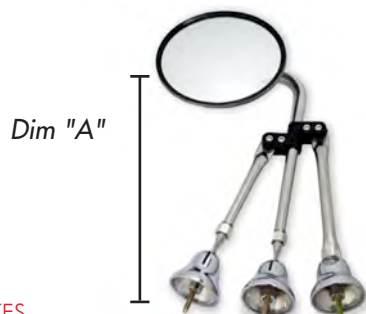

**NOTES**  
See Make section of this catalog for specific applications



Aero-Bell tripod



Velvac tripod

## ALL MAKES

### Hood Mount Mirrors

#### Velvac's LaneOptics Hood Mount Mirrors

- Two new hood mounted blind spot mirrors now available from Velvac

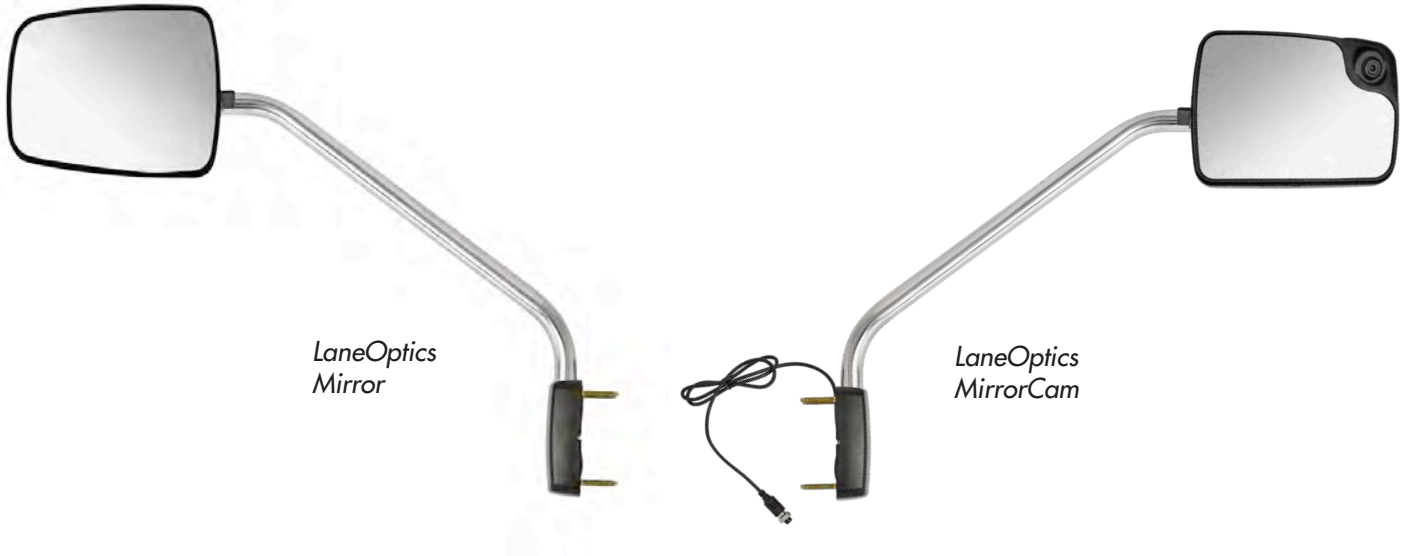

LaneOptics Mirror

LaneOptics MirrorCam

#### LaneOptics Mirror

Our new stylized aerodynamic convex mirror system combines the look and quality of a proprietary OEM hood mirror, with a universal mounting base that allows the mirror to be installed on almost any truck hood. The head can be rotated to mount to either the right or left side of the vehicle.

- Glass size – 50 square inches, 17" ROC



#### LaneOptics MirrorCam

Combines the LaneOptics mirror with an integrated color camera for blind spot visibility and ability to record events \*\*

- Glass size – 50 square inches - 17" ROC
- 73.7° FOV camera provides clear color images of passing lanes and side blind spots
- Camera angle is pre-positioned – simply adjust the mirror head to the proper viewing angle and camera is automatically oriented
- Includes five pin (B) type cable connector



Call the Velvac Sales Team: **800.783.8871** [sales@velvac.com](mailto:sales@velvac.com)

© VELVAC INC. • 2405 South Calhoun Road • New Berlin, WI 53151-2709 • Toll Free: 800.783.8871 • Fax: 262.786.4101

### Hood Mount Mirrors

#### Mirror

- Molded black, OEM approved ABS mirror housing – overall head size is 9" x 7"
- 1" O.D. stainless steel tubing arms – two lengths available for proper mirror positioning
- Black powder coated four stud universal mounting base uses same hole pattern as Velvac Pod or Mod Pod mirrors. Mounts to almost any truck hood for easy installation or retrofit
- Universal mounting hardware correctly orients mirror on the hood

| Part # | Application | Arm   | Side |
|--------|-------------|-------|------|
| 720306 | Universal   | Short | Both |
| 720308 | T700        | Short | Both |
| 720310 | Universal   | Long  | Both |

#### MirrorCam

| Left Side# | Right Side # | Application | Arm   | Connector |
|------------|--------------|-------------|-------|-----------|
| 720301     | 720300       | Universal   | Short | 5 pin     |
| 720303     | 720302       | T700        | Short | 5 pin     |
| 720305     | 720304       | Universal   | Long  | 5 pin     |

#### MODELS THAT REQUIRE LONG ARMS

Kenworth T300, T370, T660, T270

Mack CV713, CXN613

International 4300, 4400, 9200i, 4200 BX, 4300BX

Freightliner M2 106, 9335, C9218, 9336

Sterling AT9513

Hino 258ALP

| Description | Dim A  | Dim B  |
|-------------|--------|--------|
| Long Arm    | 21.81" | 31.16" |
| Short Arm   | 19.81" | 25.15" |

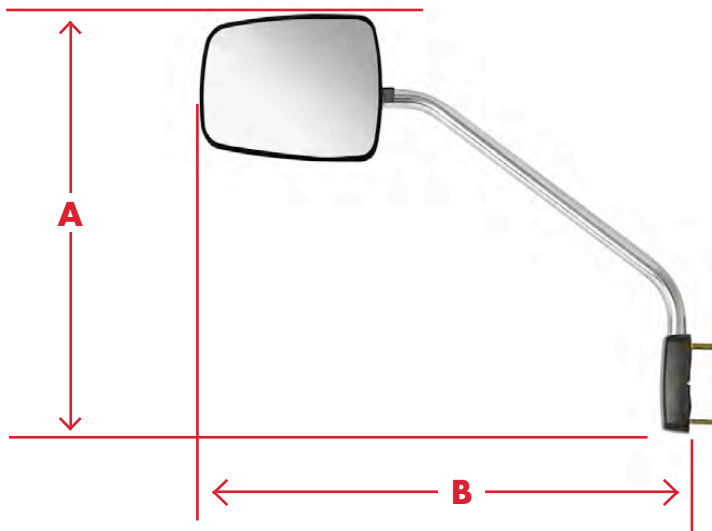

#### NOTES

\*\* Camera can be used in conjunction with any B connector monitor shown on page V6. For recording, contact us for more information on our Road IQ Video Data Server.

**NOTE: Part numbers listed in RED are NEW!**

# MIRRORS

## ALL MAKES

### Hood Mount Mirrors



Fender Bracket Assembly

Convex Glass Head

- Fender Mount

#### Side Support Range

11<sup>7</sup>/<sub>16</sub>" to 15<sup>5</sup>/<sub>16</sub>"

#### Main Support Range

17<sup>3</sup>/<sub>4</sub>" to 26<sup>3</sup>/<sub>8</sub>"

#### NOTES

**M/R** Manual / remote

See Make section of this catalog for specific applications

<sup>1</sup> Convex spot mirror with tripod assembly, fender mount

<sup>2</sup> Mirror only, fender mount

### Fender Bracket Assembly

| Model | Part #                  | Side | Color     | Material  | Heat |
|-------|-------------------------|------|-----------|-----------|------|
| 445   | V594450100 <sup>1</sup> | Both | Stainless | Stainless | -    |

### Convex Glass Head

| Model | Part #                  | Glass Size | Side | Color     | M/R    | Heat | Light |
|-------|-------------------------|------------|------|-----------|--------|------|-------|
| 445   | V564450350 <sup>2</sup> | 8"         | Both | Stainless | Manual | -    | -     |

### Rear Cross View Mirror Systems

#### RVX™/Corner Rotator



- Designed to easily mount to structural rear corner of walk-in van or high cube bodies. Fits on 90° corner with up to 1<sup>1</sup>/<sub>2</sub>" radius

- Includes factory assembled spring loaded bracket with Velvac 10" wide view or K-10 Eyeball convex mirror head
- Mirrors are designed to fold away and rotate

| Kit #  | Bracket Only # | Color                             | Head   | Rear Door Style |
|--------|----------------|-----------------------------------|--------|-----------------|
| 715213 | -              | White                             | Velvac | A, B or C       |
| 715212 | -              | Stainless steel                   | Velvac | A, B or C       |
| 716901 | 714403         | Stainless steel                   | K-10   | A, B or C       |
| 716900 | 714403         | Stainless steel w/ black ABS head | K-10   | A, B or C       |

RVX™ is a trademark of Velvac, Inc



Call the Velvac Sales Team: **800.783.8871** sales@velvac.com

© VELVAC INC. • 2405 South Calhoun Road • New Berlin, WI 53151-2709 • Toll Free: 800.783.8871 • Fax: 262.786.4101



### Rear Cross View Mirror Systems

#### Walk-In Van Bodies

| Kit #  | Bracket Only # | Color                        | Head   | Rear Door Style | Panel Mount    |
|--------|----------------|------------------------------|--------|-----------------|----------------|
| 712644 | 712642         | White                        | Velvac | A or C          | Rear standard  |
| 712643 | 712641         | Stainless steel              | Velvac | A or C          | Rear standard  |
| 716906 | 712647         | Stainless steel              | K-10   | A or C          | Rear standard  |
| 716907 | 713752         | Stainless steel              | K-10   | A or C          | Rear breakaway |
| 716903 | 715101         | Stainless steel              | K-10   | D               | Side           |
| 716902 | 715101         | Stainless steel w/ black ABS | K-10   | D               | Side           |

#### Rear Van Door Styles



Roll-up narrow



Roll-up full



Hinged narrow



Hinged full

#### Panel Mount Styles

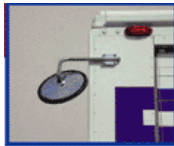

Rear standard



Rear breakaway



Side mount

- Universal mounting bracket fits walk-in vans and vehicles with flat mounting surfaces
- Kits include mirror head, reinforced 3/4" O.D. tubing arm, heavy-duty mounting brackets and stainless steel hardware
- Assemblies include either a 10" Velvac wide view convex or a 10" K-10 Eyeball roll-up narrow convex mirror



#### Straight Van Chassis

| Kit #  | Bracket Only # | Color           | Head   |
|--------|----------------|-----------------|--------|
| 712640 | 712638         | Stainless steel | Velvac |

#### Vehicle:

Dodge and older GM and Ford Vans

- Kits include mirror head, bracket and stainless steel mounting hardware
- Assembly includes a Velvac 8 1/2" wide view convex

#### NOTES

See Make section of this catalog for specific applications

# MIRRORS

## ALL MAKES

### Walk-In Van Mirrors

- Universal mirrors include an adjustable loop mounting bracket that will fit most walk-in van applications
- Fixed custom mirrors include a fixed loop bracket for specific mounting applications
- All mirrors include 6½" w x 10" h upper flat glass head and 6½" w x 6" h lower convex



Fixed custom



Universal adjustable loop

| Part #              | Application                  | Description       | Color           | Mounting Centers | Loop Leg Length |
|---------------------|------------------------------|-------------------|-----------------|------------------|-----------------|
| <b>Universal</b>    |                              |                   |                 |                  |                 |
| 721090              | Various                      | Complete pair     | Stainless steel | 22" to 36.5"     | 8"              |
| 721092              | Various                      | Loop and brackets | Stainless steel | 22" to 36.5"     | 8"              |
| <b>Fixed Custom</b> |                              |                   |                 |                  |                 |
| 712323              | Grumman (Morgan) Utilimaster | Complete pair     | Stainless steel | 30.57"           | 10.5"           |
| 713404              | Utilimaster                  | Complete pair     | Stainless steel | 33.33"           | 11.69"          |
| 724007              | Various                      | Complete pair     | Stainless steel | 30.37"           | 10.42"          |
| 724008              | Various                      | Complete pair     | Stainless steel | 33"              | 8"              |
| 727067              | Various                      | Complete pair     | Stainless steel | 33"              | 8"              |

### Van and Cab Chassis Mirrors

#### Universal Low Mount Mirror System and Accessories

- Low mount mirror kit includes stainless steel bracket system, solid stainless steel elbow and 7½" x 10½" mirror head
- Wide angle conversion kit includes 6½" x 6" convex and stainless steel tube support for blind spot viewing
- Mirror heads provide over 63 square inches of flat viewing area (See page M18 for more information)



Low mount mirror kit



712245

| Part # | Description                                      | Color           |
|--------|--------------------------------------------------|-----------------|
| 712479 | Low mount mirror kit: bracket, head elbow - pair | Stainless steel |
| 748216 | Replacement elbow                                | Stainless steel |
| 712245 | Wide angle conversion kit - one side             | Stainless steel |



Call the Velvac Sales Team: **800.783.8871** [sales@velvac.com](mailto:sales@velvac.com)

© VELVAC INC. • 2405 South Calhoun Road • New Berlin, WI 53151-2709 • Toll Free: 800.783.8871 • Fax: 262.786.4101



### Truck and Tractor Mirrors

- Versatile head and loop assembly for flat side mounting on fire trucks and other specialty vehicles
- Bracket mounting span of 31 1/2" x 8.18" from body leg length
- All stainless steel construction with preset pivot breakaway system

| Part # | Description                                          | Color           | Upper Head                               | Lower Head         |
|--------|------------------------------------------------------|-----------------|------------------------------------------|--------------------|
| 713760 | Complete pair                                        | Stainless steel | 8" x 16" Remote heated west coast mirror | 6 1/2" x 6" Convex |
| 713769 | Complete pair                                        | Stainless steel | 7" x 16" OE V-back west coast mirror     | 6 1/2" x 6" Convex |
| 713759 | Replacement loop bracket, mounting feet and hardware | Stainless steel | N/A                                      | N/A                |

#### NOTES

See page M2 for more information on remote mirror head

See page M3 for OE V-back West Coast



Split head<sup>1</sup>

West coast<sup>2</sup>

- All kits shown below are packaged as pairs. Loop and clamp kits include both short clamps for use with split wide angle heads and long clamps for west coast heads



Conventional tractor bracket kit

### Universal Bracket Kit and Head/Loop System

- Universal stainless steel bracket kit is fully adjustable to fit a variety of conventional straight truck and tractor doors; it extends out a maximum of 20" from door
- Use head and loop assemblies in combination with universal bracket kit to produce a complete major system for conventional truck and tractors; loop span is 17.56"

| Part # | Description                                | Color           | Upper Head   | Lower Head  |
|--------|--------------------------------------------|-----------------|--------------|-------------|
| 700064 | Universal conventional tractor bracket kit | Stainless steel | N/A          | N/A         |
| 701001 | Head and loop - split head                 | White           | 6 1/2" x 10" | 6 1/2" x 6" |
| 701006 | Head and loop - split head                 | Stainless steel | 6 1/2" x 10" | 6 1/2" x 6" |
| 701050 | Head and loop - west coast                 | White           | 7" x 16"     | N/A         |
| 701054 | Head and loop - west coast                 | Stainless steel | 7" x 16"     | N/A         |
| 701071 | Loop and clamp kit                         | White           | N/A          | N/A         |
| 701072 | Loop and clamp kit                         | Stainless steel | N/A          | N/A         |

#### NOTES

<sup>1</sup> See page M20 and M21 for replacement mirror heads

<sup>2</sup> See page M4 and M5 for replacement mirror heads

## CATERPILLAR

461 System | CT660



Actuator

### Vehicle:

CT660 (2011-Present)

- Fits 1 1/8" tube

### Head Size

8 1/8" w x 20 5/16" h x 5" d

### NOTES

<sup>1</sup> Furnished with cable assembly without turn signal

<sup>2</sup> Furnished with cable assembly for turn signal

Bracket, head and glass not available.  
Contact OE to purchase.

### Flat Mirror Actuators

| Model | Part #                  | O.E.M.     | Side |
|-------|-------------------------|------------|------|
| 461   | V614610002 <sup>1</sup> | 2609911C91 | Both |
| 461   | V614610003 <sup>2</sup> | 2609912C91 | Both |



Call the Velvac Sales Team: **800.783.8871** [sales@velvac.com](mailto:sales@velvac.com)

© VELVAC INC. • 2405 South Calhoun Road • New Berlin, WI 53151-2709 • Toll Free: 800.783.8871 • Fax: 262.786.4101

Cyclone® & Typhoon® Aerials, Custom Chassis, Custom Pumps, Rescue  
| **407 System**



Flat Glass Head



2-Mirror Switch



Actuator

### Vehicle:

Cyclone® & Typhoon® Aerials,  
Custom Chassis, Custom Pumps,  
Rescue (2004-Present)

- Fits 1-1½" tube

### Head Size

8⅞" w x 15⅞" h x 5¼" d

### Accessories

- **Marker Light Kit w/ Bezel**  
Model 427 | Part # V114272001
- **Head Clamp & Screws Kit**  
Model 400 | Part # V614000010
- **2-Mirror Switch**  
Part # V083200233  
(OEM 687993)

### NOTES

**M/R** Manual / remote

<sup>1</sup> Furnished with wiring harness for flat remote, flat/convex heat, marker light and turn signal

<sup>2</sup> Chrome backcover with chrome housing

- For Commercial Pumps, Tankers, Emax, Tradition™, Watermaster™ and Rescue consult specific make/model section of this catalog.

### Side Mount Bracket

| Model | Part #                  | Dimension "A" | Dimension "B" | Side | Color     | Material  |
|-------|-------------------------|---------------|---------------|------|-----------|-----------|
| 407   | V584070500 <sup>1</sup> | 31¾"          | 8⅞"           | Both | Stainless | Stainless |

- Dimension A: Distance between upper and lower bracket holder mounting holes
- Dimension B: Distance between the outside edge of the mirror bracket and the mounting surface

### Flat Glass Head *Glass adjustable*

| Model | Part #                  | Glass Size     | Side  | Color  | M/R    | Heat | Light |
|-------|-------------------------|----------------|-------|--------|--------|------|-------|
| 427   | V514270018 <sup>2</sup> | 7¼" w x 14¼" h | Right | Chrome | Remote | •    | •     |
| 427   | V514270017 <sup>2</sup> | 7¼" w x 14¼" h | Left  | Chrome | Remote | •    | •     |

### Flat Glass Kit

| Model | Part #     | O.E.M.    | Glass Size     | Side | Color | M/R  | Heat |
|-------|------------|-----------|----------------|------|-------|------|------|
| 427   | V154270011 | 687992003 | 7½" w x 14¼" h | Both | Black | Both | •    |

## E-ONE

### 407 System

Continued

#### Mirror Cover

| Model | Part #                    | Side | Color  | Light |
|-------|---------------------------|------|--------|-------|
| 427   | V134271009 <sup>3</sup>   | Both | Chrome | •     |
| 427   | V614271007 <sup>3,4</sup> | Both | Chrome | •     |

#### Convex Glass Head *Glass adjustable*

| Model | Part #                    | Glass Size                                                        | Side | Color  | M/R    | Heat | Light |
|-------|---------------------------|-------------------------------------------------------------------|------|--------|--------|------|-------|
| 428   | V564281015 <sup>5,6</sup> | 7 <sup>3</sup> / <sub>4</sub> " x 5 <sup>3</sup> / <sub>4</sub> " | Both | Chrome | Manual | •    | -     |

#### Convex Glass Kit

| Model | Part #                  | O.E.M.    | Glass Size                                                        | Side | Color | M/R    | Heat |
|-------|-------------------------|-----------|-------------------------------------------------------------------|------|-------|--------|------|
| 428   | V154280003 <sup>5</sup> | 687992004 | 7 <sup>3</sup> / <sub>4</sub> " x 5 <sup>3</sup> / <sub>4</sub> " | Both | Black | Manual | •    |

#### Convex Mirror Cover

| Model | Part #     | Side | Color  | Light |
|-------|------------|------|--------|-------|
| 428   | V134281015 | Both | Chrome | -     |

#### NOTES

<sup>3</sup> Furnished with punched holes

<sup>4</sup> Kit furnished with marker light

<sup>5</sup> Furnished with turn signal

<sup>6</sup> Chrome backcover with chrome housing

#### Flat Mirror Actuator

| Model | Part #     | Side |
|-------|------------|------|
| 427   | V084270006 | Both |



Call the Velvac Sales Team: **800.783.8871** [sales@velvac.com](mailto:sales@velvac.com)

© VELVAC INC. • 2405 South Calhoun Road • New Berlin, WI 53151-2709 • Toll Free: 800.783.8871 • Fax: 262.786.4101

## FERRARA FIRE APPARATUS

FD-100, HD-57, HD-77, HD-107, LP-102 Ladders. Mid & Rear Mount Platforms. Ember, Igniter, Infer-, Intruder 2, Ultra Pumpers. Custom Tankers. Heavy Rescues. Type I Wildland | **407 System**



Flat Glass Head



Mirror Cover



Convex Glass Head

### Vehicle:

FD-100, HD-57, HD-77, HD-107, LP-102 Ladders. Mid & Rear Mount Platforms. Ember, Igniter, Infer-, Intruder 2, Ultra Pumpers. Custom Tankers. Heavy Rescues. Type I Wildland (2006-Present)

- Fits 1-1/8" tube

### Head Size

8 1/16" w x 15 1/16" h x 5 1/4" d

### NOTES

**M/R** Manual / remote

<sup>1</sup> Furnished less electrical harness. Contact Velvac for specific part numbers and availability

<sup>2</sup> Chrome backcover with chrome housing

- For Commercial 2/4 Door Pumpers, Tankers, Medium Rescue and Wildlands Type III, consult specific vehicle make/model section of this catalog.

### Side Mount Bracket

| Model | Part #                  | Dimension "A" | Dimension "B" | Side | Color     | Material  |
|-------|-------------------------|---------------|---------------|------|-----------|-----------|
| 407   | V584070330 <sup>1</sup> | 35"           | 8 7/16"       | Both | Stainless | Stainless |
| 407   | V584070340 <sup>1</sup> | 35"           | 6 7/16"       | Both | Stainless | Stainless |

- Dimension A: Distance between upper and lower bracket holder mounting holes
- Dimension B: Distance between the outside edge of the mirror bracket and the mounting surface

### Flat Glass Head *Glass adjustable*

| Model | Part #                  | O.E.M.      | Glass Size           | Side  | Color  | M/R    | Heat | Light |
|-------|-------------------------|-------------|----------------------|-------|--------|--------|------|-------|
| 427   | V514270016 <sup>2</sup> | -           | 7 1/4" w x 14 1/4" h | Right | Chrome | Remote | •    | -     |
| 427   | V514270015 <sup>2</sup> | -           | 7 1/4" w x 14 1/4" h | Left  | Chrome | Remote | •    | -     |
| 427   | V514270122              | DS514270122 | 7 1/4" w x 14 1/4" h | Right | Black  | Remote | •    | -     |
| 427   | V514270121              | DS514270121 | 7 1/4" w x 14 1/4" h | Left  | Black  | Remote | •    | -     |

### Flat Glass Kit

| Model | Part #     | O.E.M.    | Glass Size           | Side | Color | M/R  | Heat |
|-------|------------|-----------|----------------------|------|-------|------|------|
| 427   | V154270011 | 101445027 | 7 1/4" w x 14 1/4" h | Both | Black | Both | •    |

## FERRARA FIRE APPARATUS

### 407 System

Continued

#### Mirror Cover

| Model | Part #     | O.E.M.                   | Side | Color  | Light |
|-------|------------|--------------------------|------|--------|-------|
| 427   | V134271008 | -                        | Both | Chrome | -     |
| 427   | V134271000 | DS134271000<br>101445029 | Both | Black  | -     |

#### Accessories

- **Head Clamp & Screws Kit**  
Model 400 | Part # V614000010

#### NOTES

<sup>2</sup> Chrome backcover with chrome housing

#### Convex Glass Head Glass adjustable

| Model | Part #                  | O.E.M.      | Glass Size  | Side | Color  | M/R    | Heat | Light |
|-------|-------------------------|-------------|-------------|------|--------|--------|------|-------|
| 428   | V564281014 <sup>2</sup> | -           | 7¾"w x 5¾"h | Both | Chrome | Manual | •    | -     |
| 428   | V564281002              | DS564281002 | 7¾"w x 5¾"h | Both | Black  | Manual | •    | -     |

#### Convex Glass Kit

| Model | Part #     | O.E.M.    | Glass Size  | Side | Color | M/R    | Heat |
|-------|------------|-----------|-------------|------|-------|--------|------|
| 428   | V154280002 | 101445028 | 7¾"w x 5¾"h | Both | Black | Manual | •    |

#### Convex Mirror Cover

| Model | Part #     | O.E.M.      | Side | Color  | Light |
|-------|------------|-------------|------|--------|-------|
| 428   | V134281015 | -           | Both | Chrome | -     |
| 428   | V134281011 | DS134281011 | Both | Black  | -     |

#### Flat Mirror Actuator

| Model | Part #     | Side |
|-------|------------|------|
| 427   | V084270006 | Both |



Call the Velvac Sales Team: **800.783.8871** [sales@velvac.com](mailto:sales@velvac.com)

© VELVAC INC. • 2405 South Calhoun Road • New Berlin, WI 53151-2709 • Toll Free: 800.783.8871 • Fax: 262.786.4101



## FORD & GM 2020 VAN AND CAB CHASSIS MIRRORS

- Velvac's 2020 and 2020XG family of mirrors feature OE fit and styling, and provide outstanding visibility of passing lanes and blind spots around the vehicle, making them the industry standard for wide body cutaway van and truck cab chassis applications. These mirrors mount directly to the OE sail area on the door for clean and easy installation. The modular design allows a single mirror style to be used across multiple van and truck platforms, making them perfect for all OE and fleet applications. In addition to the original 2020 mirrors, Velvac now offers a new 2020 Mini-LEM system with integrated camera options and our new 2020XG, the next generation in wide body mirror technology



### Model 2020 Mirror System

- Model 2020 mirrors are designed specifically for wide body applications such as high cube cutaway vans, rental trucks, Class C RV's and ambulances. The fixed length arms are designed to position the mirror beyond the body providing the driver with an unobstructed view of blind spots and passing lanes around the vehicle. These versatile mirrors are available in several body widths and finishes as well as manual or heated remote glass
- Mirrors available for 86", 96" and 102" wide bodies
- Die cast arms and bases are e-coated and powder coated for corrosion resistance
- Available in black, white and black base/arm with chrome head
- Two mirror head options:
  - Standard head with lower wedge convex
  - Deluxe head with full width lower convex
- Fold away feature allows mirrors to fold forward and back for easy vehicle storage and protection against impact

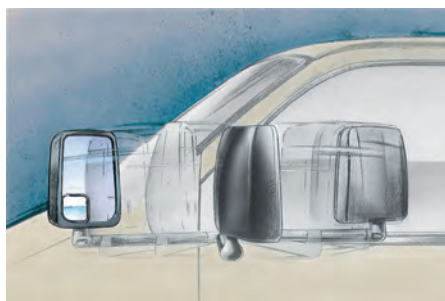

Unique pivot design



### Model 2020 Mini-LEM Mirror System

- Velvac has added the exclusive pre-positioned lower camera option to the 2020 mirror, providing even greater coverage of the blind spot areas around the vehicle. These mirrors are available with either a black and white CCD camera or the featured CMOS color camera for even greater clarity and object detection
- Camera image is reversed to provide a picture in the same orientation as the mirror image for seamless observation of blind spots and passing lanes
- CMOS color camera with infrared LED's provide greater image definition, truer colors and anti-blooming technology, allowing drivers to quickly identify objects in a variety of light conditions
- Systems can be designed to integrate with back-up cameras for complete vehicle blind spot coverage. See [Vision Systems](#) section for more information on Velvac's back-up cameras and CMOS camera technology



2020 Mini-LEM with turn signal option in flat glass

## FORD & GM 2020XG VAN AND CAB CHASSIS MIRRORS

### Model 2020XG Mirror Systems

- A combination of styling, quality and performance make the 2020XG the new benchmark for wide body mirror systems. The fully integrated arm, base and mirror head look stylish, and together reduce vibration and provide large, clear views of the blind spots and passing lanes. Since these mirrors are designed specifically for 96" and 102" wide bodies, they provide a complete vision solution with no compromising



### Style/Value

- Fully integrated base, arm and mirror head for a clean OE look
- "Swept back" design prepositions the mirror in the optimal location; no head adjustment necessary
- Stylized mirror base fits directly in the OE "sail area" mounting holes
- Rigid design for better stability and image clarity
- Easily replaceable mirror head, glass and arm components help reduce downtime and service costs

### Quality

- Die cast aluminum mounting base and upper arm are e-coated and powder coated for corrosion protection
- OEM-approved plastic mirror shell and lower arm deliver durability and UV resistance
- Pivot system allows the mirror to be folded forward or back upon impact and returned easily to the normal driving position

### Increased safety

- Advanced vibration dampening in mirror head keeps image steady even on rough road surfaces
- 63 sq. in. flat glass and 29½ sq. in. convex glass with 18" ROC provides great visibility of the passing lanes and blind spots around the vehicle

### Field of View Coverage

- Field of view diagram below shows the superior vision and blind spot coverage provided by Velvac 2020 and 2020XG mirrors relative to typical OE mirrors used on a wide body applications. Velvac's 2020 and 2020XG mirrors can help to reduce blind spots and provide visibility of multiple passing lanes around the vehicle leading to better driving decisions and the reduction of costly accidents

### Helpful hint:

Most cutaway van and cab chassis OE mirrors are not designed for body widths that extend beyond 96 & 102 inches. Misuse of these narrow OE mirrors leads to obstructed views and dangerous blind spots and may not fully meet all DOT mirror requirements based on these applications. Be confident that your wide body vehicle meets or exceeds FMVSS 111 requirements for Rear View Mirrors with Velvac's mirrors

Field of View Comparison

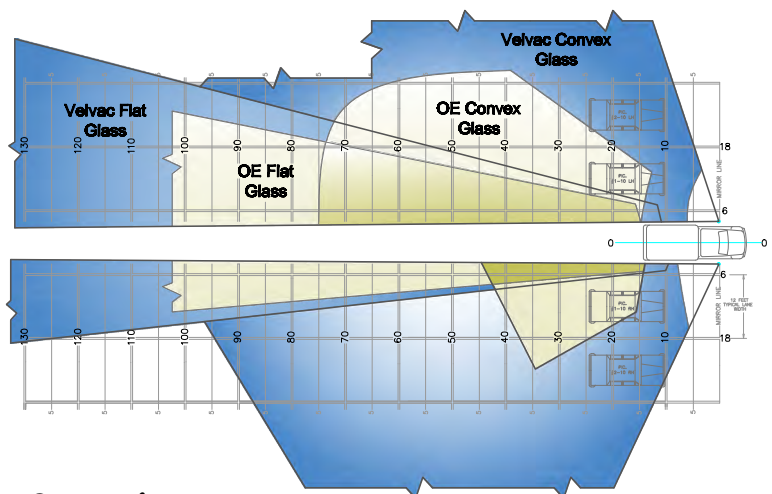

### Field of View Comparison

OV coverage: Velvac (blue), OE (green)

Information shown above represents a typical vision pattern when using Velvac 2020 or 2020XG mirrors compared to a typical OE option mirror



Call the Velvac Sales Team: **800.783.8871** [sales@velvac.com](mailto:sales@velvac.com)

© VELVAC INC. • 2405 South Calhoun Road • New Berlin, WI 53151-2709 • Toll Free: 800.783.8871 • Fax: 262.786.4101

E-Series Cutaway Van | **2020 System**



Standard

Deluxe

- **Flat Glass**

Standard 57 sq. in.  
Deluxe 62 sq. in

- **Convex Glass**

Standard wedge 10 sq. in. | 8" ROC  
Deluxe full 30 sq. in. | 12" ROC

**Vehicle:**

E-Series Cutaway Van Mirrors  
(2003-Present)

### 86" Body Width

| Model | Pair Part # | Left Side # | Right Side # | Color | Head     | Flat Glass    | Convex Glass | Options |
|-------|-------------|-------------|--------------|-------|----------|---------------|--------------|---------|
| 2020  | 715401      | 715403      | 715402       | Black | Standard | Manual        | -            | -       |
| 2020  | 715419      | 715421      | 715420       | Black | Standard | Heat / Remote | -            | -       |
| 2020  | 715410      | 715411      | 715412       | White | Standard | Manual        | -            | -       |
| 2020  | 715428      | 715429      | 715430       | White | Standard | Heat / Remote | -            | -       |

### 96" Body Width

| Model | Pair Part # | Left Side # | Right Side # | Color | Head     | Flat Glass    | Convex Glass  | Options |
|-------|-------------|-------------|--------------|-------|----------|---------------|---------------|---------|
| 2020  | 715404      | 715405      | 715406       | Black | Standard | Manual        | -             | -       |
| 2020  | 715422      | 715423      | 715424       | Black | Standard | Heat / Remote | -             | -       |
| 2020  | 715455      | 715457      | 715456       | Black | Standard | Heat / Remote | -             | Light   |
| 2020  | 715449      | 715451      | 715450       | Black | Deluxe   | Manual        | Manual        | -       |
| 2020  | 715437      | 715439      | 715438       | Black | Deluxe   | Heat / Remote | Heat / Manual | Light   |
| 2020  | 715413      | 715415      | 715414       | White | Standard | Manual        | -             | -       |
| 2020  | 715431      | 715433      | 715432       | White | Standard | Heat / Remote | -             | -       |
| 2020  | 715443      | 715445      | 715444       | White | Deluxe   | Heat / Remote | H/M           | Light   |

### 102" Body Width

| Model | Pair Part # | Left Side # | Right Side # | Color | Head     | Flat Glass    | Convex Glass  | Options |
|-------|-------------|-------------|--------------|-------|----------|---------------|---------------|---------|
| 2020  | 715407      | 715409      | 715408       | Black | Standard | Manual        | -             | -       |
| 2020  | 715425      | 715427      | 715426       | Black | Standard | Heat / Remote | -             | -       |
| 2020  | 715458      | 715459      | 715460       | Black | Standard | Heat / Remote | -             | Light   |
| 2020  | 715452      | 715453      | 715454       | Black | Deluxe   | Manual        | Manual        | -       |
| 2020  | 715440      | 715441      | 715442       | Black | Deluxe   | Heat / Remote | Heat / Manual | Light   |
| 2020  | 715416      | 715417      | 715418       | White | Standard | Manual        | -             | -       |
| 2020  | 715434      | 715435      | 715436       | White | Standard | Heat / Remote | -             | -       |
| 2020  | 715446      | 715447      | 715448       | White | Deluxe   | Heat / Remote | Heat / Manual | Light   |

**NOTES**

**Light** Lighted arm

\*All remote mirror PAIRS include switches and wire harnesses. These items are NOT included when remote mirrors are sold as sides

Pre-2003 mirror service parts can be found on [www.velvac.com](http://www.velvac.com) by searching with a keyword "1992-2002 Ford"

# MIRRORS

## FORD

### 2020 Mini-LEM System w/ Color Camera | E-Series Cutaway Van



- **Flat Glass**  
62 sq. in
- **Convex Glass**  
30 sq. in. | 12" ROC

#### Vehicle:

E-Series Cutaway Van Mirrors  
(2003-Present)

#### 96" Body Width

| Model | Pair Part # | Left Side # | Right Side # | Color  | Head   | Flat Glass    | Convex Glass  | Options        |
|-------|-------------|-------------|--------------|--------|--------|---------------|---------------|----------------|
| 2020  | 719311      | 719313      | 719312       | Black  | Deluxe | Manual        | Manual        | -              |
| 2020  | 719317      | 719319      | 719318       | Black  | Deluxe | Heat / Remote | Heat / Manual | -              |
| 2020  | 719326      | 719327      | 719328       | Black  | Deluxe | Heat / Remote | Heat / Manual | Light          |
| 2020  | 719335      | 719337      | 719336       | Black  | Deluxe | Heat / Remote | Heat / Manual | Signal         |
| 2020  | 719344      | 719345      | 719346       | Black  | Deluxe | Heat / Remote | Heat / Manual | Signal / Light |
| 2020  | 719314      | 719315      | 719316       | White  | Deluxe | Manual        | Manual        | -              |
| 2020  | 719320      | 719321      | 719322       | White  | Deluxe | Heat / Remote | Heat / Manual | -              |
| 2020  | 719329      | 719331      | 719330       | White  | Deluxe | Heat / Remote | Heat / Manual | Light          |
| 2020  | 719338      | 719339      | 719340       | White  | Deluxe | Heat / Remote | Heat / Manual | Signal         |
| 2020  | 719347      | 719349      | 719348       | White  | Deluxe | Heat / Remote | Heat / Manual | Signal / Light |
| 2020  | 719323      | 719325      | 719324       | Chrome | Deluxe | Heat / Remote | Heat / Manual | -              |
| 2020  | 719332      | 719333      | 719334       | Chrome | Deluxe | Heat / Remote | Heat / Manual | Light          |
| 2020  | 719341      | 719343      | 719342       | Chrome | Deluxe | Heat / Remote | Heat / Manual | Signal         |
| 2020  | 719350      | 719351      | 719352       | Chrome | Deluxe | Heat / Remote | Heat / Manual | Signal / Light |

#### 102" Body Width

| Model | Pair Part # | Left Side # | Right Side # | Color  | Head   | Flat Glass    | Convex Glass  | Options        |
|-------|-------------|-------------|--------------|--------|--------|---------------|---------------|----------------|
| 2020  | 719353      | 719355      | 719354       | Black  | Deluxe | Manual        | Manual        | -              |
| 2020  | -           | 719361      | 719360       | Black  | Deluxe | Heat / Remote | Heat / Manual | -              |
| 2020  | 719368      | 719369      | 719370       | Black  | Deluxe | Heat / Remote | Heat / Manual | Light          |
| 2020  | 719379      | 719381      | 719380       | Black  | Deluxe | Heat / Remote | Heat / Manual | Signal         |
| 2020  | 719388      | 719389      | 719390       | Black  | Deluxe | Heat / Remote | Heat / Manual | Signal / Light |
| 2020  | 719356      | 719357      | 719358       | White  | Deluxe | Manual        | Manual        | -              |
| 2020  | 719362      | 719363      | 719364       | White  | Deluxe | Heat / Remote | Heat / Manual | -              |
| 2020  | 719371      | 719373      | 719372       | White  | Deluxe | Heat / Remote | Heat / Manual | Light          |
| 2020  | 719382      | 719383      | 719384       | White  | Deluxe | Heat / Remote | Heat / Manual | Signal         |
| 2020  | 719391      | 719393      | 719392       | White  | Deluxe | Heat / Remote | Heat / Manual | Signal / Light |
| 2020  | 719365      | 719367      | 719366       | Chrome | Deluxe | Heat / Remote | Heat / Manual | -              |
| 2020  | 719374      | 719375      | 719376       | Chrome | Deluxe | Heat / Remote | Heat / Manual | Light          |
| 2020  | 719385      | 719387      | 719386       | Chrome | Deluxe | Heat / Remote | Heat / Manual | Signal         |
| 2020  | 719394      | 719395      | 719396       | Chrome | Deluxe | Heat / Remote | Heat / Manual | Signal / Light |

#### NOTES

**Light** Lighted arm

**Signal** Signal arrow in glass

\*All remote mirror PAIRS include switches and wire harnesses. These items are NOT included when remote mirrors are sold as sides

Pre-2003 mirror service parts can be found on [www.velvac.com](http://www.velvac.com) by searching with a keyword "1992-2002 Ford"



Call the Velvac Sales Team: **800.783.8871** [sales@velvac.com](mailto:sales@velvac.com)

© VELVAC INC. • 2405 South Calhoun Road • New Berlin, WI 53151-2709 • Toll Free: 800.783.8871 • Fax: 262.786.4101

E-Series Cutaway Van | **2020XG System**



### 96" Body Width

#### Vehicle:

E-Series Cutaway Van Mirrors  
(2003-Present)

- **Flat Glass**  
64 sq. in
- **Convex Glass**  
29 sq. in. | 18" ROC

| Model  | Pair Part # | Left Side # | Right Side # | Color  | Flat Glass    | Convex Glass  | Options |
|--------|-------------|-------------|--------------|--------|---------------|---------------|---------|
| 2020XG | 715899      | 715901      | 715900       | Black  | Manual        | Manual        | -       |
| 2020XG | 715905      | 715907      | 715906       | Black  | Heat / Remote | Heat / Manual | -       |
| 2020XG | 716346      | 716347      | 716348       | Black  | Heat / Remote | Heat / Manual | Light   |
| 2020XG | 716343      | 716345      | 716344       | Black  | Heat / Remote | Heat / Manual | Signal  |
| 2020XG | 715902      | 715903      | 715904       | White  | Manual        | Manual        | -       |
| 2020XG | 715908      | 715909      | 715910       | White  | Heat / Remote | Heat / Manual | -       |
| 2020XG | 716382      | 716383      | 716384       | White  | Heat / Remote | Heat / Manual | Light   |
| 2020XG | 716379      | 716381      | 716380       | White  | Heat / Remote | Heat / Manual | Signal  |
| 2020XG | 715953      | 715955      | 715954       | Chrome | Heat / Remote | Heat / Manual | -       |
| 2020XG | 716414      | 716415      | 716416       | Chrome | Heat / Remote | Heat / Manual | Light   |
| 2020XG | 716411      | 716413      | 716412       | Chrome | Heat / Remote | Heat / Manual | Signal  |

### 102" Body Width

| Model  | Pair Part # | Left Side # | Right Side # | Color  | Flat Glass    | Convex Glass  | Options |
|--------|-------------|-------------|--------------|--------|---------------|---------------|---------|
| 2020XG | 715923      | 715925      | 715924       | Black  | Manual        | Manual        | -       |
| 2020XG | 715929      | 715931      | 715930       | Black  | Heat / Remote | Heat / Manual | -       |
| 2020XG | 716322      | 716323      | 716324       | Black  | Heat / Remote | Heat / Manual | Light   |
| 2020XG | 716319      | 716321      | 716320       | Black  | Heat / Remote | Heat / Manual | Signal  |
| 2020XG | 715926      | 715927      | 715928       | White  | Manual        | Manual        | -       |
| 2020XG | 715932      | 715933      | 715934       | White  | Heat / Remote | Heat / Manual | -       |
| 2020XG | 716370      | 716371      | 716372       | White  | Heat / Remote | Heat / Manual | Light   |
| 2020XG | 716367      | 716369      | 716368       | White  | Heat / Remote | Heat / Manual | Signal  |
| 2020XG | 715971      | 715973      | 715972       | Chrome | Heat / Remote | Heat / Manual | -       |
| 2020XG | 716394      | 716395      | 716396       | Chrome | Heat / Remote | Heat / Manual | Light   |
| 2020XG | 716391      | 716393      | 716392       | Chrome | Heat / Remote | Heat / Manual | Signal  |

#### NOTES

**Light** Lighted head

**Signal** Signal arrow in glass

**Chrome** Chrome head with black arm and base

\*All remote mirror PAIRS include switches and wire harnesses. These items are NOT included when remote mirrors are sold as sides

Pre-2003 mirror service parts can be found on [www.velvac.com](http://www.velvac.com) by searching with a keyword "1992-2002 Ford"

# MIRRORS

## FORD

### 2020XG System | Ford F Series



#### Vehicle:

Ford 250-550 (Up to 2016)

Ford 650-750

- **Flat Glass**  
64 sq. in
- **Convex Glass**  
29 sq. in. | 18" ROC

#### 96" Body Width

| Model  | Pair Part # | Left Side # | Right Side # | Color  | Head   | Flat Glass    | Convex Glass  | Options |
|--------|-------------|-------------|--------------|--------|--------|---------------|---------------|---------|
| 2020XG | 716355      | 716357      | 716356       | Black  | Deluxe | Manual        | Manual        | -       |
| 2020XG | 716358      | 716359      | 716360       | Black  | Deluxe | Heat / Remote | Heat / Manual | -       |
| 2020XG | 716364      | 716365      | 716366       | Black  | Deluxe | Heat / Remote | Heat / Manual | Light   |
| 2020XG | 716361      | 716363      | 716362       | Black  | Deluxe | Heat / Remote | Heat / Manual | Signal  |
| 2020XG | 716423      | 716425      | 716424       | Chrome | Deluxe | Heat / Remote | Heat / Manual | -       |
| 2020XG | 716429      | 716431      | 716430       | Chrome | Deluxe | Heat / Remote | Heat / Manual | Light   |
| 2020XG | 716426      | 716427      | 716428       | Chrome | Deluxe | Heat / Remote | Heat / Manual | Signal  |

#### 102" Body Width

| Model  | Pair Part # | Left Side # | Right Side # | Color  | Head   | Flat Glass    | Convex Glass  | Options |
|--------|-------------|-------------|--------------|--------|--------|---------------|---------------|---------|
| 2020XG | 716331      | 716333      | 716332       | Black  | Deluxe | Manual        | Manual        | -       |
| 2020XG | 716334      | 716335      | 716336       | Black  | Deluxe | Heat / Remote | Heat / Manual | -       |
| 2020XG | 716340      | 716341      | 716342       | Black  | Deluxe | Heat / Remote | Heat / Manual | Light   |
| 2020XG | 716337      | 716339      | 716338       | Black  | Deluxe | Heat / Remote | Heat / Manual | Signal  |
| 2020XG | 716402      | 716403      | 716404       | Chrome | Deluxe | Heat / Remote | Heat / Manual | -       |
| 2020XG | 716408      | 716409      | 716410       | Chrome | Deluxe | Heat / Remote | Heat / Manual | Light   |
| 2020XG | 716405      | 716407      | 716406       | Chrome | Deluxe | Heat / Remote | Heat / Manual | Signal  |

#### NOTES

**Light** Lighted head

**Signal** Signal arrow in glass

**Chrome** Chrome head with black arm and base

\*All remote mirror PAIRS include switches and wire harnesses. These items are NOT included when remote mirrors are sold as sides

Pre-2003 mirror service parts can be found on [www.velvac.com](http://www.velvac.com) by searching with a keyword "1992-2002 Ford"



Call the Velvac Sales Team: **800.783.8871** [sales@velvac.com](mailto:sales@velvac.com)

© VELVAC INC. • 2405 South Calhoun Road • New Berlin, WI 53151-2709 • Toll Free: 800.783.8871 • Fax: 262.786.4101

E-Series Cutaway Van | **2020XG Mini-LEM System**

**Vehicle:**

 E-Series Cutaway Van Mirrors  
(2003-Present)

- **Flat Glass**  
64 sq. in
- **Convex Glass**  
29 sq. in. | 18" ROC

**96" Body Width**

| Model  | Pair Part # | Left Side # | Right Side # | Color  | Head   | Flat Glass    | Convex Glass  | Options |
|--------|-------------|-------------|--------------|--------|--------|---------------|---------------|---------|
| 2020XG | 717516      | 717517      | 717518       | Black  | Deluxe | Heat / Remote | Heat / Manual | -       |
| 2020XG | 717523      | 717525      | 717524       | Black  | Deluxe | Heat / Remote | Heat / Manual | Signal  |
| 2020XG | 718612      | 718613      | 718614       | White  | Deluxe | Heat / Remote | Heat / Manual | -       |
| 2020XG | 717541      | 717543      | 717542       | Chrome | Deluxe | Heat / Remote | Heat / Manual | -       |
| 2020XG | 717544      | 717545      | 717546       | Chrome | Deluxe | Heat / Remote | Heat / Manual | Signal  |

**102" Body Width**

| Model  | Pair Part # | Left Side # | Right Side # | Color  | Head   | Flat Glass    | Convex Glass  | Options |
|--------|-------------|-------------|--------------|--------|--------|---------------|---------------|---------|
| 2020XG | 717504      | 717505      | 717506       | Black  | Deluxe | Heat / Remote | Heat / Manual | -       |
| 2020XG | 717526      | 717527      | 717528       | Black  | Deluxe | Heat / Remote | Heat / Manual | Signal  |
| 2020XG | 718615      | 718617      | 718616       | White  | Deluxe | Heat / Remote | Heat / Manual | -       |
| 2020XG | 717507      | 717509      | 717508       | Chrome | Deluxe | Heat / Remote | Heat / Manual | -       |
| 2020XG | 717547      | 717549      | 717548       | Chrome | Deluxe | Heat / Remote | Heat / Manual | Signal  |

**NOTES**
**Signal** Signal arrow in glass

**Chrome** Chrome head with black arm and base

\*All remote mirror PAIRS include switches and wire harnesses. These items are NOT included when remote mirrors are sold as sides

Pre-2003 mirror service parts can be found on [www.velvac.com](http://www.velvac.com) by searching with a keyword "1992-2002 Ford"

# MIRRORS

## FORD

### 2020XG Mini-LEM System | Ford F Series



#### Vehicle:

Ford 250-550 (Up to 2016)

Ford 650-750

- **Flat Glass**  
64 sq. in
- **Convex Glass**  
29 sq. in | 18" ROC

#### 96" Body Width

| Model  | Pair Part # | Left Side # | Right Side # | Color  | Head   | Flat Glass    | Convex Glass  | Options |
|--------|-------------|-------------|--------------|--------|--------|---------------|---------------|---------|
| 2020XG | 717586      | 717587      | 717588       | Black  | Deluxe | Heat / Remote | Heat / Manual | -       |
| 2020XG | 717589      | 717591      | 717590       | Black  | Deluxe | Heat / Remote | Heat / Manual | Signal  |
| 2020XG | 717598      | 717599      | 717600       | Chrome | Deluxe | Heat / Remote | Heat / Manual | -       |
| 2020XG | 717601      | 717603      | 717602       | Chrome | Deluxe | Heat / Remote | Heat / Manual | Signal  |

#### 102" Body Width

| Model  | Pair Part # | Left Side # | Right Side # | Color  | Head   | Flat Glass    | Convex Glass  | Options |
|--------|-------------|-------------|--------------|--------|--------|---------------|---------------|---------|
| 2020XG | 717592      | 717593      | 717594       | Black  | Deluxe | Heat / Remote | Heat / Manual | -       |
| 2020XG | 717595      | 717597      | 717596       | Black  | Deluxe | Heat / Remote | Heat / Manual | Signal  |
| 2020XG | 717607      | 717609      | 717608       | Chrome | Deluxe | Heat / Remote | Heat / Manual | Signal  |

#### NOTES

**Signal** Signal arrow in glass

**Chrome** Chrome head with black arm and base

\*All remote mirror PAIRS include switches and wire harnesses. These items are NOT included when remote mirrors are sold as sides

Pre-2003 mirror service parts can be found on [www.velvac.com](http://www.velvac.com) by searching with a keyword "1992-2002 Ford"

### 2020XG Mini LEM System w/ OAT | Ford F450 - F550



#### Vehicle:

Ford F450 - F550 Series (Up to 2016)

- **Flat Glass**  
64 sq. in
- **Convex Glass**  
29 sq. in | 18" ROC

#### 102" Body Width

| Model  | Pair Part # | Left Side # | Right Side # | Color  | Head   | Flat Glass    | Convex Glass  | Options |
|--------|-------------|-------------|--------------|--------|--------|---------------|---------------|---------|
| 2020XG | 717866      | 717867      | 717868       | Chrome | Deluxe | Heat / Remote | Heat / Manual | -       |

#### NOTES

\*All remote mirror PAIRS include switches and harnesses - except new mirrors with OAT

\*\* New mirrors with OAT (outside air temperature) connect directly to OE harness and are controlled by Ford heat,

power and light controls for fast and easy installation



Call the Velvac Sales Team: **800.783.8871** [sales@velvac.com](mailto:sales@velvac.com)

© VELVAC INC. • 2405 South Calhoun Road • New Berlin, WI 53151-2709 • Toll Free: 800.783.8871 • Fax: 262.786.4101



### Ford F450 - F550 | 2020XG System w/ OAT



#### Vehicle:

Ford F450 - F550 Series (Up to 2016)

- **Flat Glass**  
64 sq. in
- **Convex Glass**  
29 sq. in | 18" ROC

#### 96" Body Width

| Model  | Pair Part # | Left Side # | Right Side # | Color  | Head   | Flat Glass    | Convex Glass  | Options |
|--------|-------------|-------------|--------------|--------|--------|---------------|---------------|---------|
| 2020XG | 717379      | 717381      | 717380       | Black  | Deluxe | Manual        | Manual        | -       |
| 2020XG | 717181      | 717183      | 717182       | Black  | Deluxe | Heat / Remote | Heat / Manual | -       |
| 2020XG | 717174      | 717175      | 717176       | Black  | Deluxe | Heat / Remote | Heat / Manual | Light   |
| 2020XG | 717513      | 717515      | 717514       | Chrome | Deluxe | Heat / Remote | Heat / Manual | -       |

#### 102" Body Width

| Model  | Pair Part # | Left Side # | Right Side # | Color  | Head   | Flat Glass    | Convex Glass  | Options |
|--------|-------------|-------------|--------------|--------|--------|---------------|---------------|---------|
| 2020XG | 717382      | 717383      | 717384       | Black  | Deluxe | Manual        | Manual        | -       |
| 2020XG | 717187      | 717189      | 717188       | Black  | Deluxe | Heat / Remote | Heat / Manual | -       |
| 2020XG | 717184      | 717185      | 717186       | Black  | Deluxe | Heat / Remote | Heat / Manual | Light   |
| 2020XG | 717501      | 717503      | 717502       | Chrome | Deluxe | Heat / Remote | Heat / Manual | -       |

#### Vehicle:

Ford F450 - F550 Series (2017 - Present)

**NOTE:** Newer vehicles require an adapter kit; PNs include necessary electrical connectors, adapter kit, mounting hardware and install instructions

#### 96" Body Width

| Model  | Pair Part # | Left Side # | Right Side # | Color | Head   | Flat Glass    | Convex Glass  | Options |
|--------|-------------|-------------|--------------|-------|--------|---------------|---------------|---------|
| 2020XG | 719748      | 719749      | 719750       | Black | Deluxe | Heat / Remote | Heat / Manual | Light   |
| 2020XG | 719751      | 719753      | 719752       | Black | Deluxe | Heat / Remote | Heat / Manual | -       |

#### 102" Body Width

| Model  | Pair Part # | Left Side # | Right Side # | Color  | Head   | Flat Glass    | Convex Glass  | Options |
|--------|-------------|-------------|--------------|--------|--------|---------------|---------------|---------|
| 2020XG | 719754      | 719755      | 719756       | Black  | Deluxe | Heat / Remote | Heat / Manual | Light   |
| 2020XG | 719757      | 719759      | 719758       | Black  | Deluxe | Heat / Remote | Heat / Manual | -       |
| 2020XG | 719760      | 719761      | 719762       | Chrome | Deluxe | Heat / Remote | Heat / Manual | -       |

#### NOTES

**Light** Lighted arm

**Chrome** Chrome head with black arm and base

\*All remote mirror PAIRS include switches and harnesses - except new mirrors with OAT

\*\* New mirrors with OAT (outside air temperature) connect directly to OE harness and are controlled by Ford heat, power and light controls for fast and easy installation

**NOTE: Part numbers listed in RED are NEW!**

# MIRRORS

## FORD

### 2020 System | Ford F Series



Standard



Deluxe

#### Vehicle:

Ford 250-550 (Up to 2016)

Ford 650-750

- **Flat Glass**

Standard 57 sq. in.

Deluxe 62 sq. in

- **Convex Glass**

Standard wedge 10 sq. in. | 8" ROC

Deluxe full 30 sq. in. | 12" ROC

### 86" Body Width

| Model | Pair Part # | Left Side # | Right Side # | Color | Head     | Flat Glass | Convex Glass | Options |
|-------|-------------|-------------|--------------|-------|----------|------------|--------------|---------|
| 2020  | 715141      | 715154      | 715153       | Black | Standard | Manual     | -            | -       |

### 96" Body Width

| Model | Pair Part # | Left Side # | Right Side # | Color  | Head     | Flat Glass    | Convex Glass  | Options |
|-------|-------------|-------------|--------------|--------|----------|---------------|---------------|---------|
| 2020  | 714527      | 714529      | 714528       | Black  | Standard | Manual        | -             | -       |
| 2020  | 714533      | 714535      | 714534       | Black  | Standard | Heat / Remote | -             | -       |
| 2020  | 714539      | 714541      | 714540       | Black  | Standard | Heat / Remote | -             | Light   |
| 2020  | 714515      | 714517      | 714516       | Black  | Deluxe   | Manual        | Manual        | -       |
| 2020  | 714521      | 714523      | 714522       | Black  | Deluxe   | Heat / Remote | Heat / Manual | Light   |
| 2020  | 715859      | 715861      | 715860       | Chrome | Deluxe   | Heat / Remote | Heat / Manual | Light   |

### 102" Body Width

| Model | Pair Part # | Left Side # | Right Side # | Color | Head     | Flat Glass    | Convex Glass  | Options |
|-------|-------------|-------------|--------------|-------|----------|---------------|---------------|---------|
| 2020  | 714530      | 714531      | 714532       | Black | Standard | Manual        | -             | -       |
| 2020  | 714536      | 714537      | 714538       | Black | Standard | Heat / Remote | -             | -       |
| 2020  | 714542      | 714543      | 714544       | Black | Standard | Heat / Remote | -             | Light   |
| 2020  | 714518      | 714519      | 714520       | Black | Deluxe   | Manual        | Manual        | -       |
| 2020  | 714524      | 714525      | 714526       | Black | Deluxe   | Heat / Remote | Heat / Manual | Light   |
| 2020  | 715131      | 715133      | 715132       | White | Deluxe   | Heat / Remote | Heat / Manual | Light   |

#### NOTES

**Light** Lighted arm

\*All remote mirror PAIRS include switches and harnesses



Call the Velvac Sales Team: **800.783.8871** sales@velvac.com

© VELVAC INC. • 2405 South Calhoun Road • New Berlin, WI 53151-2709 • Toll Free: 800.783.8871 • Fax: 262.786.4101

### Ford E Van | 2020SS Shuttle Mirror System



#### Vehicle:

Ford E Van

- **Flat Glass**  
Superstar 51½ sq in  
Deluxe 63.3 sq in
- **Convex Glass**  
Superstar 23½ sq. in.  
Deluxe 30 sq. in.

**96" Body Width** Velvac also offers the 96" 2020SS mirrors in a 93" configuration for when the bus configuration or customer specifications require it. Please contact Velvac for 93" mirror part numbers.

| Model  | Pair Part # | Left Side # | Right Side # | Head   | Flat Glass    | Convex Glass  | Options |
|--------|-------------|-------------|--------------|--------|---------------|---------------|---------|
| 2020SS | 728525      | 728527      | 728526       | Deluxe | Manual        | Manual        | -       |
| 2020SS | 728515      | 728513      | 728514       | Deluxe | Heat / Remote | Heat / Manual | -       |
| 2020SS | 728555      | 728557      | 728556       | Deluxe | Heat / Remote | Heat / Manual | Light   |
| 2020SS | 728561      | 728563      | 728562       | Deluxe | Heat / Remote | Heat / Manual | Signal  |
| 2020SS | 728521      | 728519      | 728520       | Deluxe | Heat / Remote | Heat / Remote | -       |
| 2020SS | 728534      | 728535      | 728536       | Deluxe | Heat / Remote | Heat / Remote | Light   |
| 2020SS | 728573      | 728575      | 728574       | Deluxe | Heat / Remote | Heat / Remote | Signal  |

#### 102" Body Width

| Model  | Pair Part # | Left Side # | Right Side # | Head      | Flat Glass    | Convex Glass | Options |
|--------|-------------|-------------|--------------|-----------|---------------|--------------|---------|
| 2020SS | 728754      | 728755      | 728756       | Superstar | Manual        | Manual       | -       |
| 2020SS | 728757      | 728759      | 728758       | Deluxe    | Manual        | Manual       | -       |
| 2020SS | 728766      | 728767      | 728768       | Deluxe    | Heat / Remote | Heat         | -       |

### 2020SS Shuttle Mini LEM System

#### 96" Body Width

| Model  | Pair Part # | Left Side # | Right Side # | Head   | Flat Glass    | Convex Glass  | Options |
|--------|-------------|-------------|--------------|--------|---------------|---------------|---------|
| 2020SS | 719305      | 719307      | 719306       | Deluxe | Heat / Remote | Heat / Manual | -       |
| 2020SS | 719515      | 719517      | 719516       | Deluxe | Heat / Remote | Heat / Remote | -       |

#### 102" Body Width

| Model  | Pair Part # | Left Side # | Right Side # | Head   | Flat Glass    | Convex Glass | Options |
|--------|-------------|-------------|--------------|--------|---------------|--------------|---------|
| 2020SS | 728778      | 728779      | 728780       | Deluxe | Heat / Remote | Heat         | -       |

#### NOTES

- Light** Lighted arm
- Signal** Signal arrow in glass

# MIRRORS

## FORD

### 408 System | LCF L45, L55

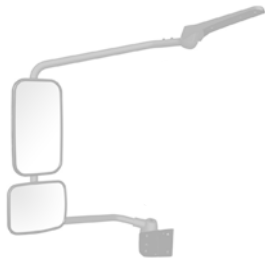

Flat Glass Head



Convex Glass Kit



Head Clamp & Screw Kit

#### Vehicle:

LCF L45, L55 (2004-2009)

- Fits 1 - 1 1/8" tube

#### Flat Head Size

7 1/4"w x 12 3/8"h x 3 1/2"d

#### Convex Head Size

8 7/8"w x 6 7/8"h x 4 1/8"d

#### Accessories

- **Head Clamp & Screw Kit**

Model 405 | Part # V624059999  
(OEM 2507274C1)

#### NOTES

**M/R** Manual / remote

<sup>1</sup> Includes bezel kit

Bracket not available. Contact OE to purchase.

#### Flat Glass Head *Head adjustable*

| Model | Part #     | O.E.M.    | Glass Size     | Side | Color | M/R    | Heat | Light |
|-------|------------|-----------|----------------|------|-------|--------|------|-------|
| 408   | V514080002 | 2588800C2 | 6 3/4"w x 12"h | Both | Black | Manual | -    | -     |

#### Flat Glass Kit

| Model | Part #                  | O.E.M.                   | Glass Size     | Side | Color | M/R    | Heat |
|-------|-------------------------|--------------------------|----------------|------|-------|--------|------|
| 408   | V614080001 <sup>1</sup> | 25589155C1<br>25589155C2 | 6 3/4"w x 12"h | Both | Black | Manual | -    |

#### Convex Glass Head *Head adjustable*

| Model | Part #     | O.E.M.    | Glass Size        | Side | Color | M/R    | Heat | Light |
|-------|------------|-----------|-------------------|------|-------|--------|------|-------|
| 408   | V564080002 | 2588801C2 | 8 1/8"w x 6 1/8"h | Both | Black | Manual | -    | -     |

#### Convex Glass Kit

| Model | Part #                  | O.E.M.     | Glass Size        | Side | Color | M/R    | Heat |
|-------|-------------------------|------------|-------------------|------|-------|--------|------|
| 408   | V614080002 <sup>1</sup> | 2589156C91 | 8 1/8"w x 6 1/8"h | Both | Black | Manual | •    |



Call the Velvac Sales Team: **800.783.8871** sales@velvac.com

© VELVAC INC. • 2405 South Calhoun Road • New Berlin, WI 53151-2709 • Toll Free: 800.783.8871 • Fax: 262.786.4101

Ford E-Van | **Rear Cross View Mirror System**

**Straight Van Chassis**
**Vehicle:**

Ford E-Van (1992-Present)

- Kits include mirror head, bracket and stainless steel mounting hardware
- Assemblies include either a Velvac 8½" wide view convex or an 8½" K-10 Eyeball convex mirror

| Kit #  | Bracket Only # | Color           | Head   |
|--------|----------------|-----------------|--------|
| 713120 | 713118         | White           | Velvac |
| 713121 | 713119         | Stainless steel | Velvac |
| 716908 | 713204         | Stainless steel | K-10   |

 Ford E-Van | **Door / Fender Mirror System**

**Vehicle:**

Ford E-Van (1992-Present)

- Complete kit includes one door mount head / bracket and one fender mount head / bracket
- All stainless steel construction

| Pair Part # | Description                   |
|-------------|-------------------------------|
| 713154      | Door / fender - complete pair |

# MIRRORS

## FORD

### West Coast System | F650/ F750



#### Vehicle:

F650 / F750 (Up to 2015)

#### NOTES

**M/R** Manual / remote

Order head and bracket to make complete mirror system

#### Bracket Assembly

| Part # | Side  |
|--------|-------|
| 719267 | Left  |
| 719268 | Right |



#### West Coast Head

| Part # | Glass Size | Side | Color           | M/R    | Heat | Light |
|--------|------------|------|-----------------|--------|------|-------|
| 705148 | 7"w x 16"h | Both | Stainless steel | Manual | •    | •     |
| 705150 | 7"w x 16"h | Both | Stainless steel | Manual | -    | -     |

#### Convex Glass Head

| Part # | Glass Size | Side | Color           | M/R    | Heat | Light |
|--------|------------|------|-----------------|--------|------|-------|
| 708685 | 8½"        | Both | Stainless steel | Manual | -    | -     |



Call the Velvac Sales Team: **800.783.8871** [sales@velvac.com](mailto:sales@velvac.com)

© VELVAC INC. • 2405 South Calhoun Road • New Berlin, WI 53151-2709 • Toll Free: 800.783.8871 • Fax: 262.786.4101

Columbia, Century, FLD | **Hood Mount Mirrors**

### Aero-Bell™ Tripod

- Stylized single piece chrome plated ABS bells and molded nylon clamps help conceal hardware giving the mirror a clean, aerodynamic appearance
- Corrosion resistant materials eliminate rust

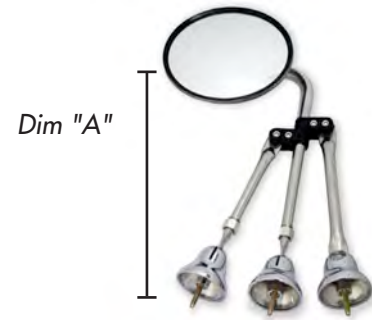

| tubing<br>Brace | Convex<br>Mirror Head        | Mounting Bells          | Tube<br>Clamps     | Hardware        | Packaging   |
|-----------------|------------------------------|-------------------------|--------------------|-----------------|-------------|
| Stainless steel | 8½" Stainless steel DuraBall | Molded/chrome plate ABS | Molded black nylon | Stainless steel | Display box |

### Fixed Arm Mirror/Bracket

| Part # | Dim A  |
|--------|--------|
| 715168 | 20.35" |

### Vehicle:

Columbia and Century

### Fixed Arm Mirror/Bracket

| Part # | Dim A  |
|--------|--------|
| 715166 | 23.55" |

### Vehicle:

FLD

Aero-Bell™ is a trademark of Velvac, Inc

## FREIGHTLINER

384 System | Century

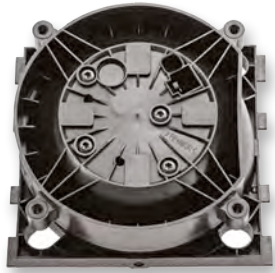

Actuator



RAMI CB Insulator Kit

### Vehicle:

Century (1995-2003)

- Fits 1 1/8" tube

### Head Size

9 1/16" w x 23 5/8" h x 5 3/8" d

### Accessories

- **CB Antenna Holder**  
Model 384 | Part # V083840200  
(OEM MEK083840200L)
- **Replacement CB Harness**  
Model 384 | Part # V093841100  
(OEM MEK093841100)
- **RAMI CB Insulator Kit**  
Model 387 | Part # V613871900  
(OEM MEK613871900)

### NOTES

<sup>1</sup> Single actuator, horizontal movement only

<sup>2</sup> Single actuator, vertical movement only

Bracket, head and glass not available.  
Contact OE to purchase.

### Flat Mirror Actuators

| Model | Part #                  | O.E.M.       | Side |
|-------|-------------------------|--------------|------|
| 384   | V613846012 <sup>1</sup> | MEK613846012 | Both |
| 384   | V613846022 <sup>2</sup> | MEK613846022 | Both |



Call the Velvac Sales Team: **800.783.8871** [sales@velvac.com](mailto:sales@velvac.com)





Flat Glass Kit

Convex Glass Kit

RAMI CB Insulator Kit

### Vehicle:

Columbia (1999-2002)

- Fits 1 - 1 $\frac{1}{8}$ " tube

### Flat Head Size

7 $\frac{5}{16}$ "w x 16 $\frac{3}{8}$ "h x 4 $\frac{5}{8}$ "d

### Convex Head Size

7 $\frac{1}{4}$ "w x 7 $\frac{1}{4}$ "h x 5 $\frac{1}{8}$ "d

### Accessories

- **CB Bracket Parts Kit**

Model 409 | Part # V614090029  
(OEM MEK614090029)

- **RAMI CB Insulator Kit**

Model 387 | Part # V613871900  
(OEM MEK613871900)

- **Head Clamp & Screw Kit**

Model 405 | Part # V624059999  
(OEM MEK624059999)

### NOTES

**M/R** Manual / remote

Bracket not available. Contact OE to purchase.

**Flat Glass Housing** Head adjustable. Order glass to make complete head

| Model | Part #     | O.E.M.                     | Glass Size                               | Side  | Color  | M/R                 | Heat <sup>2</sup> | Light |
|-------|------------|----------------------------|------------------------------------------|-------|--------|---------------------|-------------------|-------|
| 409   | V614090024 | A2254884005                | 6 $\frac{3}{4}$ "w x 15 $\frac{7}{8}$ "h | Right | Chrome | Remote <sup>1</sup> | •                 | -     |
| 409   | V614090023 | A2254884004                | 6 $\frac{3}{4}$ "w x 15 $\frac{7}{8}$ "h | Left  | Chrome | Remote <sup>1</sup> | •                 | -     |
| 409   | V614090022 | A2254884002<br>A2254884003 | 6 $\frac{3}{4}$ "w x 15 $\frac{7}{8}$ "h | Both  | Chrome | Manual              | •                 | -     |
| 409   | V614090021 | A2254884001                | 6 $\frac{3}{4}$ "w x 15 $\frac{7}{8}$ "h | Both  | Chrome | Manual              | -                 | -     |
| 409   | V614090033 | A2254884012                | 6 $\frac{3}{4}$ "w x 15 $\frac{7}{8}$ "h | Right | Black  | Remote <sup>1</sup> | •                 | -     |
| 409   | V614090032 | A2254884013                | 6 $\frac{3}{4}$ "w x 15 $\frac{7}{8}$ "h | Left  | Black  | Remote <sup>1</sup> | •                 | -     |
| 409   | V614090031 | A2254884014                | 6 $\frac{3}{4}$ "w x 15 $\frac{7}{8}$ "h | Both  | Black  | Manual              | •                 | -     |
| 409   | V614090030 | A2254884015                | 6 $\frac{3}{4}$ "w x 15 $\frac{7}{8}$ "h | Both  | Black  | Manual              | -                 | -     |
| 409   | V614090028 | A2254884011                | 6 $\frac{3}{4}$ "w x 15 $\frac{7}{8}$ "h | Right | Gray   | Remote <sup>1</sup> | •                 | -     |
| 409   | V614090027 | A2254884010                | 6 $\frac{3}{4}$ "w x 15 $\frac{7}{8}$ "h | Left  | Gray   | Remote <sup>1</sup> | •                 | -     |
| 409   | V614090026 | A2254884009                | 6 $\frac{3}{4}$ "w x 15 $\frac{7}{8}$ "h | Both  | Gray   | Manual              | •                 | -     |
| 409   | V614090025 | A2254884007                | 6 $\frac{3}{4}$ "w x 15 $\frac{7}{8}$ "h | Both  | Gray   | Manual              | -                 | -     |

### Flat Glass Kit

| Model | Part #     | O.E.M.      | Glass Size                               | Side | Color | M/R  | Heat |
|-------|------------|-------------|------------------------------------------|------|-------|------|------|
| 383   | V153832107 | A2254882002 | 6 $\frac{3}{4}$ "w x 15 $\frac{7}{8}$ "h | Both | Black | Both | •    |
| 383   | V153832003 | A2254882001 | 6 $\frac{3}{4}$ "w x 15 $\frac{7}{8}$ "h | Both | Gray  | Both | •    |

<sup>1</sup> Flat glass only

<sup>2</sup> Flat and convex glass are heated

## FREIGHTLINER

### 409 System

Continued

#### Convex Glass Housing Head adjustable. Order glass to make complete head

| Model | Part #     | O.E.M.      | Glass Size  | Side | Color  | M/R    | Heat | Light |
|-------|------------|-------------|-------------|------|--------|--------|------|-------|
| 409   | V614090018 | A2254885003 | 6¾"w x 6¾"h | Both | Chrome | Manual | •    | -     |
| 409   | V614090017 | A2254885001 | 6¾"w x 6¾"h | Both | Chrome | Manual | -    | -     |
| 409   | V614090035 | A2254885013 | 6¾"w x 6¾"h | Both | Black  | Manual | •    | -     |
| 409   | V614090034 | A2254885012 | 6¾"w x 6¾"h | Both | Black  | Manual | -    | -     |
| 409   | V614090020 | A2254885009 | 6¾"w x 6¾"h | Both | Gray   | Manual | •    | -     |
| 409   | V614090019 | A2254885007 | 6¾"w x 6¾"h | Both | Gray   | Manual | -    | -     |

#### Convex Glass Kit

| Model | Part #     | O.E.M.                     | Glass Size  | Side | Color | M/R    | Heat |
|-------|------------|----------------------------|-------------|------|-------|--------|------|
| 388   | V153882117 | A2251339002<br>A2254883002 | 6¾"w x 6¾"h | Both | Black | Manual | •    |
| 388   | V153882120 | -                          | 6¾"w x 6¾"h | Both | Black | Manual | -    |
| 388   | V153882213 | A2254883001                | 6¾"w x 6¾"h | Both | Gray  | Manual | •    |
| 388   | V153882210 | A2251339000                | 6¾"w x 6¾"h | Both | Gray  | Manual | -    |

#### Flat Mirror Actuators

| Model | Part #     | O.E.M.       | Side  |
|-------|------------|--------------|-------|
| 409   | V084090002 | MEK084090002 | Right |
| 409   | V084090001 | MEK084090001 | Left  |



Call the Velvac Sales Team: **800.783.8871** [sales@velvac.com](mailto:sales@velvac.com)

Columbia | **410 System**



Flat Glass Kit



Actuator



Convex Glass Kit

### Vehicle:

Columbia (2003-2006)

- Fits 1 1/8" tube

### Flat Head Size

7 13/16" w x 16 3/4" h x 4 3/4" d

### Convex Head Size

7 13/16" w x 8 7/16" h x 5 3/8" d

### Accessories

- **RAMI CB Insulator Kit**  
Model 387 | Part # V613871900  
(OEM MEK613871900)
- **Head Clamp & Screw Kit**  
Model 405 | Part # V624059999  
(OEM MEK624059999)

### NOTES

**M/R** Manual / remote

Bracket and head not available. Contact OE to purchase.

### Flat Glass Kit

| Model | Part #     | O.E.M.      | Glass Size           | Side | Color | M/R  | Heat |
|-------|------------|-------------|----------------------|------|-------|------|------|
| 414   | V154148002 | A2258516001 | 6 7/8" w x 15 3/4" h | Both | Black | Both | •    |
| 414   | V154148001 | A2258516000 | 6 7/8" w x 15 3/4" h | Both | Black | Both | -    |

### Convex Glass Kit

| Model | Part #     | O.E.M.      | Glass Size      | Side | Color | M/R    | Heat |
|-------|------------|-------------|-----------------|------|-------|--------|------|
| 415   | V154158002 | A2259713001 | 7 1/2" w x 7" h | Both | Black | Manual | •    |
| 415   | V154158001 | A2259713000 | 7 1/2" w x 7" h | Both | Black | Manual | -    |

### Flat Mirror Actuators

| Model | Part #     | O.E.M.       | Side  |
|-------|------------|--------------|-------|
| 414   | V084143112 | MEK084143112 | Right |
| 414   | V084143012 | MEK084143012 | Left  |

# MIRRORS

## FREIGHTLINER

### 433 System | Condor



Flat Glass Kit



Actuator



Convex Glass Kit

#### Vehicle:

Condor (2005-2007)

- Fits 1 - 1 1/8" tube

#### Flat Head Size

7 13/16" w x 16 3/4" h x 4 3/4" d

#### Convex Head Size

7 13/16" w x 8 7/16" h x 5 3/8" d

#### Accessories

##### • CB Kit

Model 433 | Part # V614330001  
(OEM MEK614330001)

##### • Head Clamp & Screw Kit

Model 405 | Part # V624059999  
(OEM MEK624059999)

#### NOTES

**M/R** Manual / remote

Bracket and head not available. Contact OE to purchase.

#### Flat Glass Kit

| Model | Part #     | O.E.M.      | Glass Size           | Side | Color | M/R  | Heat |
|-------|------------|-------------|----------------------|------|-------|------|------|
| 414   | V154148002 | A2258516001 | 6 7/8" w x 15 3/4" h | Both | Black | Both | •    |
| 414   | V154148001 | A2258516000 | 6 7/8" w x 15 3/4" h | Both | Black | Both | -    |

#### Convex Glass Kit

| Model | Part #     | O.E.M.      | Glass Size      | Side | Color | M/R    | Heat |
|-------|------------|-------------|-----------------|------|-------|--------|------|
| 415   | V154158002 | A2259713001 | 7 1/2" w x 7" h | Both | Black | Manual | •    |
| 415   | V154158001 | A2259713000 | 7 1/2" w x 7" h | Both | Black | Manual | -    |

#### Flat Mirror Actuators

| Model | Part #     | O.E.M.       | Side  |
|-------|------------|--------------|-------|
| 414   | V084143112 | MEK084143112 | Right |
| 414   | V084143012 | MEK084143012 | Left  |



Call the Velvac Sales Team: **800.783.8871** sales@velvac.com

© VELVAC INC. • 2405 South Calhoun Road • New Berlin, WI 53151-2709 • Toll Free: 800.783.8871 • Fax: 262.786.4101

106, 106V, 108SD, M2 112, M2 112V, M2 114SD | **414 System**



Flat Glass Kit



Actuator



Convex Glass Kit

### Vehicle:

M2 106, M2 106V, 108SD,  
M2 112, M2 112V, M2 114SD  
(2003-Present)

- Fits 1 1/8" tube

### Flat Head Size

7 13/16" w x 16 3/4" h x 4 3/4" d

### Convex Head Size

7 13/16" w x 8 7/16" h x 5 3/8" d

### NOTES

**M/R** Manual / remote

Bracket and head not available. Contact  
OE to purchase.

### Flat Glass Kit

| Model | Part #     | O.E.M.      | Glass Size           | Side | Color | M/R  | Heat |
|-------|------------|-------------|----------------------|------|-------|------|------|
| 414   | V154148002 | A2258516001 | 6 7/8" w x 15 3/4" h | Both | Black | Both | •    |
| 414   | V154148001 | A2258516000 | 6 7/8" w x 15 3/4" h | Both | Black | Both | -    |

### Convex Glass Kit

| Model | Part #     | O.E.M.      | Glass Size      | Side | Color | M/R    | Heat |
|-------|------------|-------------|-----------------|------|-------|--------|------|
| 415   | V154158002 | A2259713001 | 7 1/2" w x 7" h | Both | Black | Manual | •    |
| 415   | V154158001 | A2259713000 | 7 1/2" w x 7" h | Both | Black | Manual | -    |

### Flat Mirror Actuators

| Model | Part #     | O.E.M.       | Side  |
|-------|------------|--------------|-------|
| 414   | V084143112 | MEK084143112 | Right |
| 414   | V084143012 | MEK084143012 | Left  |

### Accessories

- **Marker Light Assembly - Amber**  
Model 401 | Part # V084010001  
(OEM MEK084010001)
- **Marker Light Bezel**  
Model 414 | Part # V084142400
- **RAMI CB Insulator Kit**  
Model 387 | Part # V613871900  
(OEM MEK613871900)
- **Head Clamp & Screw Kit**  
Model 405 | Part # V624059999  
(OEM MEK624059999)

# MIRRORS

## FREIGHTLINER

382 System | Sterling

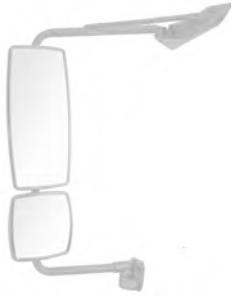

Flat Glass Kit



Actuator



Convex Glass Kit

### Vehicle:

Sterling (2002-2009)

- Fits 1 1/8" tube

### Flat Head Size

7 3/16"w x 16 3/4"h x 4 3/4"d

### Convex Head Size

7 3/16"w x 8 7/16"h x 5 3/8"d

### Accessories

- **RAMI CB Insulator Kit**  
Model 387 | Part # V613871900  
(OEM MEK613871900)
- **Head Clamp & Screw Kit**  
Model 405 | Part # V624059999  
(OEM MEK624059999)

### NOTES

**M/R** Manual / remote

Bracket and head not available. Contact OE to purchase.

### Flat Glass Kit

| Model | Part #     | O.E.M.      | Glass Size         | Side | Color | M/R  | Heat |
|-------|------------|-------------|--------------------|------|-------|------|------|
| 414   | V154148002 | A2258516001 | 6 7/8"w x 15 3/4"h | Both | Black | Both | •    |

### Convex Glass Kit

| Model | Part #     | O.E.M.      | Glass Size    | Side | Color | M/R    | Heat |
|-------|------------|-------------|---------------|------|-------|--------|------|
| 415   | V154158002 | A2259713001 | 7 1/2"w x 7"h | Both | Black | Manual | •    |
| 415   | V154158001 | A2259713000 | 7 1/2"w x 7"h | Both | Black | Manual | -    |

### Flat Mirror Actuators

| Model | Part #     | O.E.M.       | Side  |
|-------|------------|--------------|-------|
| 414   | V084143112 | MEK084143112 | Right |
| 414   | V084143012 | MEK084143012 | Left  |



Call the Velvac Sales Team: **800.783.8871** sales@velvac.com

© VELVAC INC. • 2405 South Calhoun Road • New Berlin, WI 53151-2709 • Toll Free: 800.783.8871 • Fax: 262.786.4101

Various | **Look Down Mirrors**

**Vehicle:**

Various (2003-Present)

**Bracket Mount**

**Convex Head Size**

11<sup>3</sup>/<sub>16</sub>"w x 6<sup>7</sup>/<sub>8</sub>"h x 2<sup>7</sup>/<sub>16</sub>"d

**Bracket Hole Location**

**Width Between Holes:**

3<sup>15</sup>/<sub>16</sub>"

**Hole Size:** 1<sup>1</sup>/<sub>64</sub>"

NOTES

**M/R** Manual / remote

- <sup>1</sup> Furnished with black arm, chrome back cover, black bezel and black holder
- <sup>2</sup> Furnished with black arm, black back cover, black bezel and black holder
- <sup>3</sup> Furnished with gray arm, gray back cover, gray bezel and gray holder
- <sup>4</sup> Includes bezel kit



Convex Look Down Mirror

Convex Glass Kit

**Convex Look Down Mirror**

| Model | Part #                  | O.E.M.      | Glass Size                                                           | Side  | Color  | M/R    | Heat | Light |
|-------|-------------------------|-------------|----------------------------------------------------------------------|-------|--------|--------|------|-------|
| 360   | V593605228 <sup>1</sup> | A2248560003 | 10 <sup>5</sup> / <sub>8</sub> "w x 6 <sup>1</sup> / <sub>4</sub> "h | Right | Chrome | Manual | -    | -     |
| 360   | V593601152 <sup>2</sup> | A2248560000 | 10 <sup>5</sup> / <sub>8</sub> "w x 6 <sup>1</sup> / <sub>4</sub> "h | Right | Black  | Manual | -    | -     |
| 360   | V593601428 <sup>3</sup> | A2248560002 | 10 <sup>5</sup> / <sub>8</sub> "w x 6 <sup>1</sup> / <sub>4</sub> "h | Right | Gray   | Manual | -    | -     |

**Convex Glass Kit**

| Model | Part #                  | O.E.M.        | Glass Size                                                           | Side | Color | M/R    | Heat |
|-------|-------------------------|---------------|----------------------------------------------------------------------|------|-------|--------|------|
| 360   | V613600001 <sup>4</sup> | MEK613600001F | 10 <sup>5</sup> / <sub>8</sub> "w x 6 <sup>1</sup> / <sub>4</sub> "h | Both | Black | Manual | -    |
| 360   | V613600002 <sup>4</sup> | MEK613600002  | 10 <sup>5</sup> / <sub>8</sub> "w x 6 <sup>1</sup> / <sub>4</sub> "h | Both | Gray  | Manual | -    |

# MIRRORS

## FREIGHTLINER

### Look Down Mirrors | Various Continued



#### Vehicle:

Various (2003-Present)

#### Bracket Mount

#### Convex Head Size

11<sup>1</sup>/<sub>16</sub>"w x 6<sup>3</sup>/<sub>4</sub>"h x 2<sup>5</sup>/<sub>8</sub>"d

#### Bracket Hole Location

#### Width Between Holes:

3<sup>15</sup>/<sub>16</sub>" or 2<sup>3</sup>/<sub>4</sub>"

#### Hole Size: 1<sup>1</sup>/<sub>64</sub>"

#### NOTES

**M/R** Manual / remote

<sup>1</sup> Furnished with black mounting bracket, black housing and stainless steel shroud

<sup>2</sup> Furnished with black mounting bracket and black housing

<sup>3</sup> Furnished with gray mounting bracket and gray housing

### Convex Look Down Mirror

| Model | Part #                  | O.E.M.      | Glass Size                                                           | Side  | Color     | M/R    | Heat | Light |
|-------|-------------------------|-------------|----------------------------------------------------------------------|-------|-----------|--------|------|-------|
| 412   | V594121261 <sup>1</sup> | A2258773002 | 10 <sup>3</sup> / <sub>4</sub> "w x 6 <sup>3</sup> / <sub>8</sub> "h | Right | Stainless | Manual | -    | -     |
| 412   | V594121161 <sup>2</sup> | A2258773000 | 10 <sup>3</sup> / <sub>4</sub> "w x 6 <sup>3</sup> / <sub>8</sub> "h | Right | Black     | Manual | -    | -     |
| 412   | V594121461 <sup>3</sup> | A2258773001 | 10 <sup>3</sup> / <sub>4</sub> "w x 6 <sup>3</sup> / <sub>8</sub> "h | Right | Gray      | Manual | -    | -     |

### Fender Mount Mirrors | Various



Fender Bracket Assembly

Convex Glass Head

#### Vehicle:

Various

- Fender Mount

#### Side Support Range

11<sup>7</sup>/<sub>16</sub>" to 15<sup>5</sup>/<sub>16</sub>"

#### Main Support Range

17<sup>3</sup>/<sub>4</sub>" to 26<sup>3</sup>/<sub>8</sub>"

#### NOTES

**M/R** Manual / remote

<sup>1</sup> Convex spot mirror with tripod assembly, fender mount

<sup>2</sup> Mirror only, fender mount

### Fender Bracket Assembly

| Model | Part #                  | O.E.M.      | Side | Color     | Material  | Heat |
|-------|-------------------------|-------------|------|-----------|-----------|------|
| 445   | V594450100 <sup>1</sup> | A2259733000 | Both | Stainless | Stainless | -    |

### Convex Glass Head

| Model | Part #                  | O.E.M.       | Glass Size | Side | Color     | M/R    | Heat | Light |
|-------|-------------------------|--------------|------------|------|-----------|--------|------|-------|
| 445   | V564450350 <sup>2</sup> | MEK564450350 | 8"         | Both | Stainless | Manual | -    | -     |



Call the Velvac Sales Team: **800.783.8871** sales@velvac.com

© VELVAC INC. • 2405 South Calhoun Road • New Berlin, WI 53151-2709 • Toll Free: 800.783.8871 • Fax: 262.786.4101



GM Cutaway Van | **2020 System**



Standard

Deluxe

### 78" Body Width

- **Flat Glass**  
Standard 57 sq. in.  
Deluxe 62 sq. in.
- **Convex Glass**  
Standard wedge 10 sq. in. | 8" ROC  
Deluxe full 30 sq. in. | 12" ROC

**NOTE: See pages M37 & M38 for product information**

### Vehicle:

GM Cutaway Van Mirrors



| Model | Pair Part # | Left Side # | Right Side # | Color | Head   | Flat Glass | Convex Glass | Options |
|-------|-------------|-------------|--------------|-------|--------|------------|--------------|---------|
| 2020  | 718389-5    | 718391-5    | 718390-5     | Black | Deluxe | Manual     | Manual       | -       |

### 86" Body Width

| Model | Pair Part # | Left Side # | Right Side # | Color | Head     | Flat Glass    | Convex Glass | Options |
|-------|-------------|-------------|--------------|-------|----------|---------------|--------------|---------|
| 2020  | 714601      | 714603      | 714602       | Black | Standard | Manual        | -            | -       |
| 2020  | 714604      | 714605      | 714606       | Black | Standard | Heat / Remote | -            | -       |
| 2020  | 714591      | 714593      | 714592       | Black | Deluxe   | Manual        | Manual       | -       |

### 96" Body Width

| Model | Pair Part # | Left Side # | Right Side # | Color | Head     | Flat Glass    | Convex Glass  | Options |
|-------|-------------|-------------|--------------|-------|----------|---------------|---------------|---------|
| 2020  | 714557      | 714559      | 714558       | Black | Standard | Manual        | -             | -       |
| 2020  | 714563      | 714565      | 714564       | Black | Standard | Heat / Remote | -             | -       |
| 2020  | 714569      | 714571      | 714570       | Black | Standard | Heat / Remote | -             | Light   |
| 2020  | 714545      | 714547      | 714546       | Black | Deluxe   | Manual        | Manual        | -       |
| 2020  | 714551      | 714553      | 714552       | Black | Deluxe   | Heat / Remote | Heat / Manual | Light   |
| 2020  | 714916      | 714917      | 714918       | White | Standard | Heat / Remote | -             | -       |
| 2020  | 714910      | 714911      | 714912       | White | Standard | Manual        | -             | -       |
| 2020  | 714904      | 714905      | 714906       | White | Deluxe   | Heat / Remote | Heat / Manual | Light   |

### 102" Body Width

| Model | Pair Part # | Left Side # | Right Side # | Color | Head     | Flat Glass    | Convex Glass  | Options |
|-------|-------------|-------------|--------------|-------|----------|---------------|---------------|---------|
| 2020  | 714560      | 714561      | 714562       | Black | Standard | Manual        | -             | -       |
| 2020  | 714566      | 714567      | 714568       | Black | Standard | Heat / Remote | -             | -       |
| 2020  | 714572      | 714573      | 714574       | Black | Standard | Heat / Remote | -             | Light   |
| 2020  | 714548      | 714549      | 714550       | Black | Deluxe   | Manual        | Manual        | -       |
| 2020  | 714554      | 714555      | 714556       | Black | Deluxe   | Heat / Remote | Heat / Manual | Light   |
| 2020  | 714913      | 714915      | 714914       | White | Standard | Manual        | -             | -       |
| 2020  | 714919      | 714921      | 714920       | White | Standard | Heat / Remote | -             | -       |
| 2020  | 714907      | 714909      | 714908       | White | Deluxe   | Heat / Remote | Heat / Manual | Light   |

**NOTES**  
**Light** Lighted arm

\*All remote mirror PAIRS include switches and wire harnesses. These items are NOT included when remote mirrors are sold as sides

NOTE: GMC Silverado mirror assemblies can be found on [www.velvac.com](http://www.velvac.com) by searching with a keyword "Silverado"

# MIRRORS

**GM**

## 2020 Mini LEM System | GM Cutaway Van



- **Flat Glass**  
62 sq. in
- **Convex Glass**  
30 sq. in. | 12" ROC

**Vehicle:**

GM Cutaway Van Mirrors

### 96" Body Width

| Model | Pair Part # | Left Side # | Right Side # | Color  | Head   | Flat Glass    | Convex Glass  | Options        |
|-------|-------------|-------------|--------------|--------|--------|---------------|---------------|----------------|
| 2020  | 719397      | 719399      | 719398       | Black  | Deluxe | Manual        | Manual        | -              |
| 2020  | 719403      | 719405      | 719404       | Black  | Deluxe | Heat / Remote | Heat / Manual | -              |
| 2020  | 719412      | 719413      | 719414       | Black  | Deluxe | Heat / Remote | Heat / Manual | Light          |
| 2020  | 719421      | 719423      | 719422       | Black  | Deluxe | Heat / Remote | Heat / Manual | Signal         |
| 2020  | 719430      | 719431      | 719432       | Black  | Deluxe | Heat / Remote | Heat / Manual | Signal / Light |
| 2020  | 719400      | 719401      | 719402       | White  | Deluxe | Manual        | Manual        | -              |
| 2020  | 719406      | 719407      | 719408       | White  | Deluxe | Heat / Remote | Heat / Manual | -              |
| 2020  | 719415      | 719417      | 719416       | White  | Deluxe | Heat / Remote | Heat / Manual | Light          |
| 2020  | 719424      | 719425      | 719426       | White  | Deluxe | Heat / Remote | Heat / Manual | Signal         |
| 2020  | 719433      | 719435      | 719434       | White  | Deluxe | Heat / Remote | Heat / Manual | Signal / Light |
| 2020  | 719409      | 719411      | 719410       | Chrome | Deluxe | Heat / Remote | Heat / Manual | -              |
| 2020  | 719418      | 719419      | 719420       | Chrome | Deluxe | Heat / Remote | Heat / Manual | Light          |
| 2020  | 719427      | 719429      | 719428       | Chrome | Deluxe | Heat / Remote | Heat / Manual | Signal         |
| 2020  | 719436      | 719437      | 719438       | Chrome | Deluxe | Heat / Remote | Heat / Manual | Signal / Light |

### 102" Body Width

| Model | Pair Part # | Left Side # | Right Side # | Color  | Head   | Flat Glass    | Convex Glass  | Options        |
|-------|-------------|-------------|--------------|--------|--------|---------------|---------------|----------------|
| 2020  | 719439      | 719441      | 719440       | Black  | Deluxe | Manual        | Manual        | -              |
| 2020  | 719445      | 719447      | 719446       | Black  | Deluxe | Heat / Remote | Heat / Manual | -              |
| 2020  | 719454      | 719455      | 719456       | Black  | Deluxe | Heat / Remote | Heat / Manual | Light          |
| 2020  | 719463      | 719465      | 719464       | Black  | Deluxe | Heat / Remote | Heat / Manual | Signal         |
| 2020  | 719472      | 719474      | 719473       | Black  | Deluxe | Heat / Remote | Heat / Manual | Signal / Light |
| 2020  | 719442      | 719443      | 719444       | White  | Deluxe | Manual        | Manual        | -              |
| 2020  | 719448      | 719449      | 719450       | White  | Deluxe | Heat / Remote | Heat / Manual | -              |
| 2020  | 719457      | 719459      | 719458       | White  | Deluxe | Heat / Remote | Heat / Manual | Light          |
| 2020  | 719466      | 719467      | 719468       | White  | Deluxe | Heat / Remote | Heat / Manual | Signal         |
| 2020  | 719475      | 719477      | 719476       | White  | Deluxe | Heat / Remote | Heat / Manual | Signal / Light |
| 2020  | 719451      | 719453      | 719452       | Chrome | Deluxe | Heat / Remote | Heat / Manual | -              |
| 2020  | 719460      | 719461      | 719462       | Chrome | Deluxe | Heat / Remote | Heat / Manual | Light          |
| 2020  | 719469      | 719471      | 719470       | Chrome | Deluxe | Heat / Remote | Heat / Manual | Signal         |
| 2020  | 719478      | 719479      | 719480       | Chrome | Deluxe | Heat / Remote | Heat / Manual | Signal / Light |

**NOTES**

**Light** Lighted arm  
**Signal** Signal arrow in glass

\*All remote mirror PAIRS include switches and wire harnesses. These items are NOT included when remote mirrors are sold as sides



Call the Velvac Sales Team: **800.783.8871** sales@velvac.com

© VELVAC INC. • 2405 South Calhoun Road • New Berlin, WI 53151-2709 • Toll Free: 800.783.8871 • Fax: 262.786.4101

## GM Cutaway Van | 2020XG System



### Vehicle:

GM Cutaway Van Mirrors

- **Flat Glass**  
64 sq. in
- **Convex Glass**  
29 sq. in. | 18" ROC

### 96" Body Width

| Model  | Pair Part # | Left Side # | Right Side # | Color  | Flat Glass    | Convex Glass  | Options |
|--------|-------------|-------------|--------------|--------|---------------|---------------|---------|
| 2020XG | 715911      | 715913      | 715912       | Black  | Manual        | Manual        | -       |
| 2020XG | 715917      | 715919      | 715918       | Black  | Heat / Remote | Heat / Manual | -       |
| 2020XG | 716352      | 716353      | 716354       | Black  | Heat / Remote | Heat / Manual | Light   |
| 2020XG | 716349      | 716351      | 716350       | Black  | Heat / Remote | Heat / Manual | Signal  |
| 2020XG | 715914      | 715915      | 715916       | White  | Manual        | Manual        | -       |
| 2020XG | 715920      | 715921      | 715922       | White  | Heat / Remote | Heat / Manual | -       |
| 2020XG | 716388      | 716389      | 716390       | White  | Heat / Remote | Heat / Manual | Light   |
| 2020XG | 716385      | 716387      | 716386       | White  | Heat / Remote | Heat / Manual | Signal  |
| 2020XG | 715962      | 715963      | 715964       | Chrome | Heat / Remote | Heat / Manual | -       |
| 2020XG | 716420      | 716421      | 716422       | Chrome | Heat / Remote | Heat / Manual | Light   |
| 2020XG | 716417      | 716419      | 716418       | Chrome | Heat / Remote | Heat / Manual | Signal  |

### 102" Body Width

| Model  | Pair Part # | Left Side # | Right Side # | Color  | Flat Glass    | Convex Glass  | Options |
|--------|-------------|-------------|--------------|--------|---------------|---------------|---------|
| 2020XG | 715935      | 715937      | 715936       | Black  | Manual        | Manual        | -       |
| 2020XG | 715941      | 715943      | 715942       | Black  | Heat / Remote | Heat / Manual | -       |
| 2020XG | 716328      | 716329      | 716330       | Black  | Heat / Remote | Heat / Manual | Light   |
| 2020XG | 716325      | 716327      | 716326       | Black  | Heat / Remote | Heat / Manual | Signal  |
| 2020XG | 715938      | 715939      | 715940       | White  | Manual        | Manual        | -       |
| 2020XG | 715944      | 715945      | 715946       | White  | Heat / Remote | Heat / Manual | -       |
| 2020XG | 716376      | 716377      | 716378       | White  | Heat / Remote | Heat / Manual | Light   |
| 2020XG | 716373      | 716375      | 716374       | White  | Heat / Remote | Heat / Manual | Signal  |
| 2020XG | 715980      | 715981      | 715982       | Chrome | Heat / Remote | Heat / Manual | -       |
| 2020XG | 716435      | 716437      | 716436       | Chrome | Heat / Remote | Heat / Manual | Light   |
| 2020XG | 716397      | 716399      | 716398       | Chrome | Heat / Remote | Heat / Manual | Signal  |

#### NOTES

**Light** Lighted head

**Signal** Signal arrow in glass

**Chrome** Chrome head with black arm and base

\*All remote mirror PAIRS include switches and wire harnesses. These items are NOT included when remote mirrors are sold as sides

NOTE: GMC Silverado mirror assemblies can be found on [www.velvac.com](http://www.velvac.com) by searching with a keyword "Silverado"

# MIRRORS

**GM**

## 2020XG System for GM Cut w/ 8D8 Option | GM Cutaway Van



### Vehicle:

GM Cutaway Van Mirrors

- **Flat Glass**  
64 sq. in
- **Convex Glass**  
29 sq. in. | 18" ROC
- Mirrors connect directly to OE door harness and are controlled by OE switches, making installation fast and easy

### 96" Body Width

| Model  | Pair Part # | Left Side # | Right Side # | Color  | Head   | Flat Glass    | Convex Glass  | Options |
|--------|-------------|-------------|--------------|--------|--------|---------------|---------------|---------|
| 2020XG | 718416      | 718417      | 718418       | Black  | Deluxe | Heat / Remote | Heat / Manual | -       |
| 2020XG | 718419      | 718421      | 718420       | Black  | Deluxe | Heat / Remote | Heat / Manual | Light   |
| 2020XG | 718422      | 718423      | 718424       | Black  | Deluxe | Heat / Remote | Heat / Manual | Signal  |
| 2020XG | 718434      | 718435      | 718436       | Chrome | Deluxe | Heat / Remote | Heat / Manual | -       |
| 2020XG | 718437      | 718439      | 718438       | Chrome | Deluxe | Heat / Remote | Heat / Manual | Light   |
| 2020XG | 718440      | 718441      | 718442       | Chrome | Deluxe | Heat / Remote | Heat / Manual | Signal  |

### 102" Body Width

| Model  | Pair Part # | Left Side # | Right Side # | Color  | Head   | Flat Glass    | Convex Glass  | Options |
|--------|-------------|-------------|--------------|--------|--------|---------------|---------------|---------|
| 2020XG | 718425      | 718427      | 718426       | Black  | Deluxe | Heat / Remote | Heat / Manual | -       |
| 2020XG | 718428      | 718429      | 718430       | Black  | Deluxe | Heat / Remote | Heat / Manual | Light   |
| 2020XG | 718431      | 718433      | 718432       | Black  | Deluxe | Heat / Remote | Heat / Manual | Signal  |
| 2020XG | 718443      | 718445      | 718444       | Chrome | Deluxe | Heat / Remote | Heat / Manual | -       |
| 2020XG | 718446      | 718447      | 718448       | Chrome | Deluxe | Heat / Remote | Heat / Manual | Light   |
| 2020XG | 718449      | 718451      | 718450       | Chrome | Deluxe | Heat / Remote | Heat / Manual | Signal  |

#### NOTES

**Light** Lighted arm

**Signal** Signal arrow in glass

Mirrors shown above are used on GM cutaway van chassis with 8D8 option. This option provides OE door harness and control switches with the chassis. Velvac switch and harness not included, and are not required for installation



Call the Velvac Sales Team: **800.783.8871** [sales@velvac.com](mailto:sales@velvac.com)

© VELVAC INC. • 2405 South Calhoun Road • New Berlin, WI 53151-2709 • Toll Free: 800.783.8871 • Fax: 262.786.4101

## GM Cutaway Van | 2020XG Mini-LEM System



### Vehicle:

GM Cutaway Van

- **Flat Glass**  
64 sq. in
- **Convex Glass**  
29 sq. in. | 18" ROC

### 96" Body Width

| Model  | Pair Part # | Left Side # | Right Side # | Color  | Head   | Flat Glass    | Convex Glass  | Options |
|--------|-------------|-------------|--------------|--------|--------|---------------|---------------|---------|
| 2020XG | 717550      | 717551      | 717552       | Black  | Deluxe | Heat / Remote | Heat / Manual | -       |
| 2020XG | 717553      | 717555      | 717554       | Black  | Deluxe | Heat / Remote | Heat / Manual | Signal  |
| 2020XG | 718618      | 718619      | 718620       | White  | Deluxe | Heat / Remote | Heat / Manual | -       |
| 2020XG | 717574      | 717575      | 717576       | Chrome | Deluxe | Heat / Remote | Heat / Manual | -       |
| 2020XG | 717577      | 717579      | 717578       | Chrome | Deluxe | Heat / Remote | Heat / Manual | Signal  |

### 102" Body Width

| Model  | Pair Part # | Left Side # | Right Side # | Color  | Head   | Flat Glass    | Convex Glass  | Options |
|--------|-------------|-------------|--------------|--------|--------|---------------|---------------|---------|
| 2020XG | 717556      | 717557      | 717558       | Black  | Deluxe | Heat / Remote | Heat / Manual | -       |
| 2020XG | 717559      | 717561      | 717560       | Black  | Deluxe | Heat / Remote | Heat / Manual | Signal  |
| 2020XG | 718621      | 718623      | 718622       | White  | Deluxe | Heat / Remote | Heat / Manual | -       |
| 2020XG | 717580      | 717581      | 717582       | Chrome | Deluxe | Heat / Remote | Heat / Manual | -       |
| 2020XG | 717583      | 717585      | 717584       | Chrome | Deluxe | Heat / Remote | Heat / Manual | Signal  |

#### NOTES

**Signal** Signal arrow in glass

**Chrome** Chrome head with black arm and base

\*All remote mirror PAIRS include switches and wire harnesses. These items are NOT included when remote mirrors are sold as sides

NOTE: GMC Silverado mirror assemblies can be found on [www.velvac.com](http://www.velvac.com) by searching with a keyword "Silverado"

# MIRRORS

**GM**

## 2020SS Shuttle Mirror System | GM G Van



### Vehicle:

GM G Van

- **Flat Glass**

Superstar 51½ sq in

Deluxe 63.3 sq in

- **Convex Glass**

Superstar 23½ sq. in.

Deluxe 30 sq. in.

### NOTES

**Light** Lighted arm

**Signal** Signal arrow in glass

**96" Body Width** Velvac also offers the 96" 2020SS mirrors in a 93" configuration for when the bus configuration or customer specifications require it. Please contact Velvac for 93" mirror part numbers.

| Model  | Pair Part # | Left Side # | Right Side # | Head   | Flat Glass    | Convex Glass  | Options |
|--------|-------------|-------------|--------------|--------|---------------|---------------|---------|
| 2020SS | 718525      | 718527      | 718526       | Deluxe | Manual        | Manual        | -       |
| 2020SS | 718515      | 718513      | 718514       | Deluxe | Heat / Remote | Heat / Manual | -       |
| 2020SS | 718555      | 718557      | 718556       | Deluxe | Heat / Remote | Heat / Manual | Light   |
| 2020SS | 718561      | 718563      | 718562       | Deluxe | Heat / Remote | Heat / Manual | Signal  |
| 2020SS | 718521      | 718519      | 718520       | Deluxe | Heat / Remote | Heat / Remote | -       |
| 2020SS | 718534      | 718535      | 718536       | Deluxe | Heat / Remote | Heat / Remote | Light   |
| 2020SS | 718573      | 718575      | 718574       | Deluxe | Heat / Remote | Heat / Remote | Signal  |

### 102" Body Width

| Model  | Pair Part # | Left Side # | Right Side # | Head      | Flat Glass    | Convex Glass | Options |
|--------|-------------|-------------|--------------|-----------|---------------|--------------|---------|
| 2020SS | 718754      | 718755      | 718756       | Superstar | Manual        | Manual       | -       |
| 2020SS | 718757      | 718759      | 718758       | Deluxe    | Manual        | Manual       | -       |
| 2020SS | 718763      | 718765      | 718764       | Deluxe    | Heat / Remote | Heat         | Light   |
| 2020SS | 718766      | 718767      | 718768       | Deluxe    | Heat / Remote | Heat         | -       |

## 2020SS Shuttle Mini LEM System

### 96" Body Width

| Model  | Pair Part # | Left Side # | Right Side # | Head   | Flat Glass    | Convex Glass  | Options |
|--------|-------------|-------------|--------------|--------|---------------|---------------|---------|
| 2020SS | 719301-7    | 719303      | 719302       | Deluxe | Heat / Remote | Heat / Manual | -       |
| 2020SS | 719295      | 719297      | 719296       | Deluxe | Heat / Remote | Heat / Remote | -       |



Call the Velvac Sales Team: **800.783.8871** [sales@velvac.com](mailto:sales@velvac.com)

© VELVAC INC. • 2405 South Calhoun Road • New Berlin, WI 53151-2709 • Toll Free: 800.783.8871 • Fax: 262.786.4101

## GM G Van | Door / Fender Mirror System



Fender mount assembly



Door mount assembly

### Vehicle:

GM G Van (1997-Present)

- Complete kit includes one door mount head / bracket and one fender mount head / bracket
- All stainless steel construction

| Pair Part # | Description                 |
|-------------|-----------------------------|
| 713883      | Door/fender - complete pair |

## GM G Van | Rear Cross View Mirror Systems



### Vehicle:

GM G Van (1997-Present)

- Kits include mirror head, bracket and stainless steel mounting hardware
- Assemblies include either a Velvac 8½" wide view convex or an 8½" K-10 Eyeball convex mirror

### Straight Van Chassis Applications

| Kit #  | Bracket Only # | Color           | Head   |
|--------|----------------|-----------------|--------|
| 713796 | -              | White           | Velvac |
| 713798 | -              | Stainless steel | Velvac |
| 716909 | 713993         | Stainless steel | K-10   |

## GM Low Mount Cab and Cutaway | Camper Style



### Vehicle:

GM Low Mount Cab and Cutaway Mirror Systems

- Complete with ⅜" - 16 x 2¼" mounting bolt and hardware

### Camper Style Mirror Head

| Part #   | Delbar Part # | Glass Size | Head Size    | Material        |
|----------|---------------|------------|--------------|-----------------|
| 716138-5 | HR-1164       | 63 sq. in. | 7½"w x 10½"h | Stainless steel |

# MIRRORS

## GMC

### Colorado Canyon Pickup Mirrors | Canyon Pickup Truck

| Part # | Description                      |
|--------|----------------------------------|
| 715885 | Complete pair                    |
| 715886 | Right side mirror                |
| 715887 | Left side mirror                 |
| 715888 | Right side mirror head w/ convex |
| 715889 | Left side mirror head w/ convex  |
| 723106 | Right side convex                |
| 723107 | Left side convex                 |
| 702086 | Flat glass kit                   |



#### Vehicle:

GMC Canyon Pickup Truck Chassis

- Provides views around 78" bodies to increase driver safety with enhanced view of passing lanes and blind spots
- Large 11.10 square inch convex with 12½" ROC targets blind spots
- 56.62 square inch flat glass area
- Mirrors fold forward and back for easy storage
- Black finish for OE appearance

## HINO

### 260 System | Various



#### Vehicle:

Various (2005-2006)

- Fits ⅝-¾" tube

#### Convex Head Size

7⅞" w x 6⅛" h x 3¼" d

#### NOTES

**M/R** Manual / remote

### Convex Glass Head Head adjustable

| Model | Part #     | O.E.M.     | Glass Size    | Side | Color | M/R    | Heat | Light |
|-------|------------|------------|---------------|------|-------|--------|------|-------|
| 260   | V562601127 | S8790E0010 | 7½" w x 5⅝" h | Both | Black | Manual | -    | -     |



Call the Velvac Sales Team: **800.783.8871** [sales@velvac.com](mailto:sales@velvac.com)

© VELVAC INC. • 2405 South Calhoun Road • New Berlin, WI 53151-2709 • Toll Free: 800.783.8871 • Fax: 262.786.4101



145, 165, 185, 238, 258ALP, 258LP, 268, 268A, 338, 338CT | **428 System**



Convex Glass Head



Convex Mirror Cover

### Vehicle:

145, 165, 185, 238, 258ALP, 258LP, 268, 268A, 338, 338CT (2005-Present)

- Fits 1 - 1 1/8" tube

### Convex Head Size

8 7/16" w x 6 5/8" h x 4 1/2" d

### NOTES

**M/R** Manual / remote  
Bracket not available. Contact OE to purchase.

<sup>1</sup> Chrome backcover with black housing

<sup>2</sup> Includes housing

### Convex Glass Head *Glass adjustable*

| Model | Part #                  | O.E.M.     | Glass Size          | Side | Color  | M/R    | Heat | Light |
|-------|-------------------------|------------|---------------------|------|--------|--------|------|-------|
| 428   | V564281005 <sup>1</sup> | S8790E0033 | 7 3/4" w x 5 3/4" h | Both | Chrome | Manual | -    | -     |
| 428   | V564281001              | S8790E0021 | 7 3/4" w x 5 3/4" h | Both | Black  | Manual | -    | -     |

### Convex Glass Kit

| Model | Part #                  | O.E.M.     | Glass Size          | Side | Color | M/R    | Heat |
|-------|-------------------------|------------|---------------------|------|-------|--------|------|
| 428   | V154280001              | 87931E0010 | 7 3/4" w x 5 3/4" h | Both | Black | Manual | -    |
| 428   | V614280008 <sup>2</sup> | S8702E0030 | 7 3/4" w x 5 3/4" h | Both | Black | Manual | -    |

### Convex Mirror Cover

| Model | Part #     | O.E.M.     | Side | Color  | Light |
|-------|------------|------------|------|--------|-------|
| 428   | V134281015 | S8791E0060 | Both | Chrome | -     |
| 428   | V134281011 | S8791E0050 | Both | Black  | -     |

### Accessories

- **Head Clamp & Screw Kit**

Model 400 | Part # V614000010  
(OEM 87919E0101)

# MIRRORS

## HINO

**427 System** | 145, 165, 185, 238, 258ALP, 258LP, 268, 268A, 338, 338CT



Flat Glass Head

Flat Glass Kit

Mirror Cover

### Vehicle:

145, 165, 185, 238, 258ALP,  
258LP, 268, 268A, 338, 338CT  
(2005-Present)

- Fits 1 - 1 1/8" tube

### Head Size

8 1/16" w x 15 1/16" h x 5 1/4" d

### Accessories

- **Marker Light Kit w/ Bezel**  
Model 427 | Part # V114272001
- **Head Clamp & Screw Kit**  
Model 400 | Part # V614000010  
(OEM 87919E0101)

### NOTES

**M/R** Manual / remote

<sup>1</sup> Chrome backcover with black housing  
Bracket not available. Contact OE to  
purchase.

### Flat Glass Head *Glass adjustable*

| Model | Part #                  | O.E.M.                   | Glass Size           | Side  | Color  | M/R    | Heat | Light |
|-------|-------------------------|--------------------------|----------------------|-------|--------|--------|------|-------|
| 427   | V514271108 <sup>1</sup> | 87903E0260               | 7 1/4" w x 14 1/4" h | Right | Chrome | Remote | •    | •     |
| 427   | V514271107 <sup>1</sup> | 87906E0170               | 7 1/4" w x 14 1/4" h | Left  | Chrome | Remote | •    | •     |
| 427   | V514271008 <sup>1</sup> | 87903E0043<br>87903E0042 | 7 1/4" w x 14 1/4" h | Right | Chrome | Manual | •    | •     |
| 427   | V514271007 <sup>1</sup> | 87906E0043<br>87906E0042 | 7 1/4" w x 14 1/4" h | Left  | Chrome | Manual | •    | •     |
| 427   | V514271006 <sup>1</sup> | 87903E0103<br>87903E0102 | 7 1/4" w x 14 1/4" h | Right | Chrome | Manual | -    | -     |
| 427   | V514271005 <sup>1</sup> | 87906E0063<br>87906E0062 | 7 1/4" w x 14 1/4" h | Left  | Chrome | Manual | -    | -     |
| 427   | V514270104              | 87903E0250               | 7 1/4" w x 14 1/4" h | Right | Black  | Remote | •    | •     |
| 427   | V514270103              | 87906E0160               | 7 1/4" w x 14 1/4" h | Left  | Black  | Remote | •    | •     |
| 427   | V514270004              | 87903E0030<br>87903E0031 | 7 1/4" w x 14 1/4" h | Right | Black  | Manual | •    | •     |
| 427   | V514270003              | 87906E0030<br>87906E0031 | 7 1/4" w x 14 1/4" h | Left  | Black  | Manual | •    | •     |
| 427   | V514270014              | 879010W051               | 7 1/4" w x 14 1/4" h | Right | Black  | Manual | •    | -     |
| 427   | V514270013              | 879060W010<br>879060W011 | 7 1/4" w x 14 1/4" h | Left  | Black  | Manual | •    | -     |
| 427   | V514270002              | 87903E0090<br>87903E0091 | 7 1/4" w x 14 1/4" h | Right | Black  | Manual | -    | -     |
| 427   | V514270001              | 87906E0051               | 7 1/4" w x 14 1/4" h | Left  | Black  | Manual | -    | -     |



Call the Velvac Sales Team: **800.783.8871** sales@velvac.com

© VELVAC INC. • 2405 South Calhoun Road • New Berlin, WI 53151-2709 • Toll Free: 800.783.8871 • Fax: 262.786.4101

**427 System**  
*Continued*
**Flat Glass Kit**

| Model | Part #                  | O.E.M.                   | Glass Size   | Side  | Color | M/R  | Heat |
|-------|-------------------------|--------------------------|--------------|-------|-------|------|------|
| 427   | V154270011              | 87961E0020               | 7¼"w x 14¼"h | Both  | Black | Both | •    |
| 427   | V154270010              | 87961E0010               | 7¼"w x 14¼"h | Both  | Black | Both | -    |
| 427   | V614270004 <sup>2</sup> | 87903E0170<br>87903E0171 | 7¼"w x 14¼"h | Right | Black | Both | •    |
| 427   | V614270005 <sup>2</sup> | 87906E0110               | 7¼"w x 14¼"h | Left  | Black | Both | •    |
| 427   | V614270002 <sup>2</sup> | 87903E0160<br>87903E0161 | 7¼"w x 14¼"h | Right | Black | Both | -    |
| 427   | V614270003 <sup>2</sup> | 87906E0100               | 7¼"w x 14¼"h | Left  | Black | Both | -    |

**Mirror Cover**

| Model | Part #                    | O.E.M.     | Side | Light | Color  |
|-------|---------------------------|------------|------|-------|--------|
| 427   | V134271009 <sup>3</sup>   | -          | Both | •     | Chrome |
| 427   | V134271008                | S8791E0030 | Both | -     | Chrome |
| 427   | V614271007 <sup>3,4</sup> | S8791E0040 | Both | •     | Chrome |
| 427   | V134271001 <sup>3</sup>   | -          | Both | •     | Black  |
| 427   | V134271000                | S8791E0010 | Both | -     | Black  |
| 427   | V614270006 <sup>3,4</sup> | S8791E0020 | Both | •     | Black  |

**NOTES**
<sup>2</sup> Includes housing

<sup>3</sup> Furnished with punched holes

<sup>4</sup> Furnished with marker light

**Flat Mirror Actuator**

| Model | Part #     | Side |
|-------|------------|------|
| 427   | V084270006 | Both |

# MIRRORS

## HME FIRE TRUCK CHASSIS GROUP

**407 System** | Custom Pumper, Tanker, Rescue. Platform. Scorpion™. Silverfox®



Flat Glass Head



Convex Glass Head

### Vehicle:

Custom Pumper, Tanker, Rescue. Platform. Scorpion™. Silverfox® (2004-Present)

- Fits 1- 1 1/8" tube

### Head Size

8 1/16" w x 15 1/16" h x 5 1/4" d

### NOTES

**M/R** Manual / remote

<sup>1</sup> Furnished less electrical harness. Contact Velvac for specific part numbers and availability

<sup>2</sup> Chrome backcover with chrome housing

- For Commercial Pumper, Tanker, Wolf, Wildland and Redfox, consult specific vehicle make/model section of this catalog.

### Side Mount Bracket

| Model | Part #                  | Dimension "A" | Dimension "B" | Side | Color     | Material  |
|-------|-------------------------|---------------|---------------|------|-----------|-----------|
| 407   | V584070310 <sup>1</sup> | 31 3/4"       | 7 5/16"       | Both | Stainless | Stainless |

- Dimension A: Distance between upper and lower bracket holder mounting holes
- Dimension B: Distance between the outside edge of the mirror bracket and the mounting surface

### Flat Glass Head *Glass adjustable*

| Model | Part #                  | Glass Size           | Side  | Color  | M/R    | Heat | Light |
|-------|-------------------------|----------------------|-------|--------|--------|------|-------|
| 427   | V514270016 <sup>2</sup> | 7 1/4" w x 14 1/4" h | Right | Chrome | Remote | •    | -     |
| 427   | V514270015 <sup>2</sup> | 7 1/4" w x 14 1/4" h | Left  | Chrome | Remote | •    | -     |

### Flat Glass Kit

| Model | Part #     | Glass Size           | Side | Color | M/R  | Heat |
|-------|------------|----------------------|------|-------|------|------|
| 427   | V154270011 | 7 1/4" w x 14 1/4" h | Both | Black | Both | •    |

### Mirror Cover

| Model | Part #     | Side | Color  | Light |
|-------|------------|------|--------|-------|
| 427   | V134271008 | Both | Chrome | -     |



Call the Velvac Sales Team: **800.783.8871** [sales@velvac.com](mailto:sales@velvac.com)

© VELVAC INC. • 2405 South Calhoun Road • New Berlin, WI 53151-2709 • Toll Free: 800.783.8871 • Fax: 262.786.4101

## HME FIRE TRUCK CHASSIS GROUP

**407 System**  
Continued

### Convex Glass Head *Glass adjustable*

| Model | Part #                    | Glass Size  | Side | Color  | M/R    | Heat | Light |
|-------|---------------------------|-------------|------|--------|--------|------|-------|
| 428   | V564281014 <sup>2</sup>   | 7¾"w x 5¾"h | Both | Chrome | Manual | •    | -     |
| 428   | V564281015 <sup>2,3</sup> | 7¾"w x 5¾"h | Both | Chrome | Manual | •    | -     |

### Convex Glass Kit

| Model | Part #                  | Glass Size  | Side | Color | M/R    | Heat |
|-------|-------------------------|-------------|------|-------|--------|------|
| 428   | V154280002              | 7¾"w x 5¾"h | Both | Black | Manual | •    |
| 428   | V154280003 <sup>3</sup> | 7¾"w x 5¾"h | Both | Black | Manual | •    |

### Convex Mirror Cover

| Model | Part #     | Side | Color  | Light |
|-------|------------|------|--------|-------|
| 428   | V134281015 | Both | Chrome | -     |

### Flat Mirror Actuator

| Model | Part #     | Side |
|-------|------------|------|
| 427   | V084270006 | Both |

### Accessories

- **Head Clamp & Screws Kit**  
Model 400 | Part # V614000010
- **2-Mirror Switch**  
Part # V083200233  
(OEM 79885145)

### NOTES

- <sup>2</sup> Chrome backcover with chrome housing  
<sup>3</sup> Furnished with turn signal

# MIRRORS

## INTERNATIONAL

**405 System | Standard Mirror | DuraStar, WorkStar, TranStar**



Bracket Assemblies

Flat Glass

Convex Glass

### Vehicle:

DuraStar 4100, 4200, 4200LP, 4300, 4300LP, 4400, 4400LP, 4700, 4700LP, 4700LPX, 4800, 4900, Hybrid, Mid-Cab. WorkStar 7300, 7400, 7500, 7600, 7700, Hybrid. TranStar 8100, 8100CH, 8200, 8500, 8600 (2002-Present)

- Fits 1 - 1½" tube

### NOTES

**CB** Bracket assembly furnished with wiring harness for CB

**Look Down** Bracket assembly furnished with black look down mirror

**U/L** Bracket assembly furnished with wiring harness for heated flat (upper) and convex (lower) mirrors

**M/R** Manual / remote

### Bracket Assemblies

| Model | Part #     | O.E.M.    | Side  | Color | M/R    | Heat | CB | Look Down | U/L |
|-------|------------|-----------|-------|-------|--------|------|----|-----------|-----|
| 405   | V584004001 | 2505274C3 | Left  | Black | Manual | -    | -  | -         | -   |
| 405   | V584004002 | 2505275C3 | Right | Black | Manual | -    | -  | -         | -   |
| 405   | V584004004 | 2505278C3 | Right | Black | Manual | -    | -  | •         | -   |
| 405   | V584004005 | 2505276C4 | Left  | Black | Manual | -    | •  | -         | -   |
| 405   | V584004006 | 2505277C4 | Right | Black | Manual | -    | •  | -         | -   |
| 405   | V584005009 | 2589149C2 | Left  | Black | Manual | •    | -  | -         | •   |
| 405   | V584005010 | 2589150C2 | Right | Black | Manual | •    | -  | -         | •   |
| 405   | V584005012 | 2589153C2 | Right | Black | Manual | •    | -  | •         | •   |
| 405   | V584005013 | 2589151C2 | Left  | Black | Manual | •    | •  | -         | •   |
| 405   | V584005014 | 2589152C2 | Right | Black | Manual | •    | •  | -         | •   |
| 405   | V584005016 | 2589154C2 | Right | Black | Manual | •    | •  | •         | •   |
| 405   | V584004046 | 2595651C1 | Right | Black | Remote | •    | -  | -         | •   |
| 405   | V584004048 | 2595652C1 | Right | Black | Remote | •    | -  | •         | •   |
| 405   | V584004033 | 2589844C1 | Left  | Black | Remote | •    | •  | -         | •   |
| 405   | V584004034 | 2589847C1 | Right | Black | Remote | •    | •  | -         | •   |



Call the Velvac Sales Team: **800.783.8871** sales@velvac.com

© VELVAC INC. • 2405 South Calhoun Road • New Berlin, WI 53151-2709 • Toll Free: 800.783.8871 • Fax: 262.786.4101

### 405 System

Continued

#### Flat Glass *Glass only*

| Model | Part #     | O.E.M.    | Glass Size                                                           | Side | Color | M/R  | Heat |
|-------|------------|-----------|----------------------------------------------------------------------|------|-------|------|------|
| 405   | V404055800 | 2505814C2 | 7 <sup>5</sup> / <sub>8</sub> "w x 16 <sup>3</sup> / <sub>4</sub> "h | Both | n/a   | Both | •    |
| 405   | V404055700 | 2505813C2 | 7 <sup>5</sup> / <sub>8</sub> "w x 16 <sup>3</sup> / <sub>4</sub> "h | Both | n/a   | Both | -    |

#### Convex Glass *Glass only*

| Model | Part #     | O.E.M.    | Glass Size                                                          | Side | Color | M/R    | Heat |
|-------|------------|-----------|---------------------------------------------------------------------|------|-------|--------|------|
| 406   | V404065304 | 2505816C2 | 7 <sup>5</sup> / <sub>8</sub> "w x 7 <sup>5</sup> / <sub>8</sub> "h | Both | n/a   | Manual | •    |
| 406   | V404065204 | 2505815C2 | 7 <sup>5</sup> / <sub>8</sub> "w x 7 <sup>5</sup> / <sub>8</sub> "h | Both | n/a   | Manual | -    |

#### Convex Look Down Mirror (Optional) *No mirror holder provided*

| Model | Part #     | O.E.M.                   | Glass Size                                                           | Side  | Color  | M/R    | Heat | Light |
|-------|------------|--------------------------|----------------------------------------------------------------------|-------|--------|--------|------|-------|
| 360   | V563600260 | 2506220C91<br>2506220C92 | 10 <sup>5</sup> / <sub>8</sub> "w x 6 <sup>1</sup> / <sub>4</sub> "h | Right | Chrome | Manual | -    | -     |
| 360   | V563600160 | -                        | 10 <sup>5</sup> / <sub>8</sub> "w x 6 <sup>1</sup> / <sub>4</sub> "h | Right | Black  | Manual | -    | -     |

#### Flat Head Size

8<sup>3</sup>/<sub>16</sub>"w x 17<sup>3</sup>/<sub>8</sub>"h x 4<sup>3</sup>/<sub>8</sub>"d

#### Convex Head Size

8<sup>1</sup>/<sub>8</sub>"w x 8<sup>1</sup>/<sub>8</sub>"h x 4<sup>9</sup>/<sub>16</sub>"d

#### Accessories

- **Head Clamp & Screw Kit**  
Model 405 | Part # V624059999  
(OEM 2507274C1)

# MIRRORS

## INTERNATIONAL

### 400 System | Premium Mirror | DuraStar, WorkStar, TranStar



Flat Glass Kit



CB Antenna  
Holder Assembly



Convex Glass Kit

#### Vehicle:

DuraStar 4100, 4200, 4200LP, 4300, 4300LP, 4400, 4400LP, 4700, 4700LP, 4700LPX, 4800, 4900, Hybrid, Mid-Cab. WorkStar 7300, 7400, 7500, 7600, 7700, Hybrid. TranStar 8100, 8100CH, 8200, 8500, 8600 (2002-Present)

- Fits 1 - 1½" tube

#### NOTES

- CB** Bracket assembly furnished with wiring harness for CB
- Look Down** Bracket assembly furnished with black or chrome look down mirror
- U** Bracket assembly furnished with wiring harness for lighted flat (upper) mirror
- U/L** Bracket assembly furnished with wiring harness for heated flat (upper) and convex (lower) mirrors

### 102 Inch Wide Bracket Assemblies

| Model | Part #     | O.E.M.    | Side  | Color     | M/R    | Heat | CB | Look Down | U | U/L |
|-------|------------|-----------|-------|-----------|--------|------|----|-----------|---|-----|
| 400   | V584004025 | 2506299C3 | Left  | Black     | Remote | •    | -  | -         | • | •   |
| 400   | V584004026 | 2505324C3 | Right | Black     | Remote | •    | -  | -         | • | •   |
| 400   | V584004028 | 2505811C3 | Right | Black     | Remote | •    | -  | Black     | • | •   |
| 400   | V584004029 | 2506300C4 | Left  | Black     | Remote | •    | •  | -         | • | •   |
| 400   | V584004030 | 2505302C4 | Right | Black     | Remote | •    | •  | -         | • | •   |
| 400   | V584004032 | 2505812C3 | Right | Black     | Remote | •    | •  | Black     | • | •   |
| 400   | V584004501 | 2505320C3 | Left  | Stainless | Manual | -    | -  | -         | - | -   |
| 400   | V584004502 | 2505321C3 | Right | Stainless | Manual | -    | -  | -         | - | -   |
| 400   | V584004504 | 2505301C3 | Right | Stainless | Manual | -    | -  | Chrome    | - | -   |
| 400   | V584004505 | 2505296C4 | Left  | Stainless | Manual | -    | •  | -         | - | -   |
| 400   | V584004506 | 2505298C4 | Right | Stainless | Manual | -    | •  | -         | - | -   |
| 400   | V584004509 | 2509017C3 | Left  | Stainless | Manual | •    | -  | -         | • | •   |
| 400   | V584004526 | 2599424C1 | Right | Stainless | Manual | •    | -  | -         | • | •   |
| 400   | V584004528 | 2599423C1 | Right | Stainless | Manual | •    | -  | Chrome    | • | •   |
| 400   | V584004513 | 2505304C4 | Left  | Stainless | Manual | •    | •  | -         | • | •   |
| 400   | V584004530 | 2599426C1 | Right | Stainless | Manual | •    | •  | -         | • | •   |
| 400   | V584004532 | 2599427C1 | Right | Stainless | Manual | •    | •  | Chrome    | • | •   |
| 400   | V584004517 | 2505325C3 | Left  | Stainless | Remote | •    | -  | -         | • | •   |
| 400   | V584004518 | 2505326C3 | Right | Stainless | Remote | •    | -  | -         | • | •   |
| 400   | V584004520 | 2505303C3 | Right | Stainless | Remote | •    | -  | Chrome    | • | •   |
| 400   | V584004521 | 2506298C4 | Left  | Stainless | Remote | •    | •  | -         | • | •   |
| 400   | V584004522 | 2505305C4 | Right | Stainless | Remote | •    | •  | -         | • | •   |
| 400   | V584004524 | 2505810C3 | Right | Stainless | Remote | •    | •  | Chrome    | • | •   |

**M/R** Manual / remote



Call the Velvac Sales Team: **800.783.8871** sales@velvac.com

© VELVAC INC. • 2405 South Calhoun Road • New Berlin, WI 53151-2709 • Toll Free: 800.783.8871 • Fax: 262.786.4101



#### 96 Inch Wide Bracket Assemblies

| Model | Part #     | O.E.M.    | Side  | Color     | M/R    | Heat | U | U/L |
|-------|------------|-----------|-------|-----------|--------|------|---|-----|
| 400   | V584004535 | 2596626C1 | Left  | Stainless | Remote | •    | • | •   |
| 400   | V584004536 | 2589850C1 | Right | Stainless | Remote | •    | • | •   |

#### Flat Glass Kit

| Model | Part #     | O.E.M.                 | Glass Size     | Side | Color | M/R  | Heat |
|-------|------------|------------------------|----------------|------|-------|------|------|
| 400   | V154003107 | 2505818C1<br>2505818C2 | 7¼" w x 14⅞" h | Both | Black | Both | •    |
| 400   | V154003100 | 2505817C1<br>2505817C2 | 7¼" w x 14⅞" h | Both | Black | Both | -    |

#### Convex Glass Kit

| Model | Part #                  | O.E.M.                              | Glass Size   | Side  | Color | M/R    | Heat |
|-------|-------------------------|-------------------------------------|--------------|-------|-------|--------|------|
| 400   | V154003117              | 2505820C1<br>2505820C2<br>2505820C3 | 7" w x 6⅜" h | Both  | Black | Manual | •    |
| 400   | V154003110              | 2505819C1<br>2505819C2              | 7" w x 6⅜" h | Both  | Black | Manual | -    |
| 400   | V154004002 <sup>1</sup> | 2594622C91                          | 7" w x 6⅜" h | Right | Black | Manual | •    |
| 400   | V154004001 <sup>1</sup> | 2594621C91                          | 7" w x 6⅜" h | Left  | Black | Manual | •    |

#### Flat Mirror Actuators

| Model | Part #                  | O.E.M.    | Side |
|-------|-------------------------|-----------|------|
| 400   | V094002590 <sup>2</sup> | 2592422C1 | Both |
| 425   | V094252591 <sup>3</sup> | 2595653C1 | Both |

#### Head Size

8¾" w x 24¾" h x 5⅜" d

#### NOTES

- <sup>1</sup> Furnished with turn signal
- <sup>2</sup> Furnished with cable assembly without turn signal
- <sup>5</sup> Furnished with cable assembly for turn signal

#### Convex Look Down Mirror (Optional) *No mirror holder provided*

| Model | Part #     | O.E.M.                   | Glass Size     | Side  | Color  | M/R    | Heat | Light |
|-------|------------|--------------------------|----------------|-------|--------|--------|------|-------|
| 360   | V563600260 | 2506220C91<br>2506220C92 | 10⅝" w x 6¼" h | Right | Chrome | Manual | -    | -     |
| 360   | V563600160 | -                        | 10⅝" w x 6¼" h | Right | Black  | Manual | -    | -     |

#### Accessories

- **CB Antenna Holder Assembly**  
Model 400 | Part # V084002002  
(OEM 2506242C92)
- **Replacement CB Harness**  
Model 400 | Part # V084000100  
(OEM 2506241C91)
- **Head Clamp & Screw Kit**  
Model 400 | Part # V614000010  
(OEM 2506236C91)

# MIRRORS

## INTERNATIONAL

**466 System | Universal Mirror | DuraStar, WorkStar, TranStar**

### Vehicle:

DuraStar 4100, 4200, 4200LP, 4300, 4300LP, 4400, 4400LP, 4700, 4700LP, 4700LPX, 4800, 4900, Hybrid, Mid-Cab. WorkStar 7300, 7400, 7500, 7600, 7700, Hybrid. TranStar 8100, 8100CH, 8200, 8500, 8600 (2015-Present)

- Fits 1 - 1 1/8" tube

### NOTES

- CB** Bracket assembly furnished with wiring harness for CB
- Look Down** Bracket assembly furnished with black or chrome look down mirror
- U** Bracket assembly furnished with wiring harness for lighted flat (upper) mirror
- U/L** Bracket assembly furnished with wiring harness for heated flat (upper) mirror and convex (lower) mirror
- AAT** Bracket assembly furnished with wiring harness for AAT sensor



### Bracket Assemblies

| Model | Part #     | O.E.M.    | Side  | Color     | M/R    | Heat | CB | Look Down | U | U/L | AAT |
|-------|------------|-----------|-------|-----------|--------|------|----|-----------|---|-----|-----|
| 466   | V584660019 | 2514650C1 | Left  | Stainless | Remote | •    | •  | -         | • | •   | •   |
| 466   | V584660120 | 2514652C1 | Right | Stainless | Remote | •    | •  | Chrome    | • | •   | -   |
| 466   | V584660020 | 2514651C1 | Right | Stainless | Remote | •    | •  | -         | • | •   | -   |
| 466   | V584660017 | 2514647C1 | Left  | Stainless | Remote | •    | -  | -         | • | •   | •   |
| 466   | V584660118 | 2514649C1 | Right | Stainless | Remote | •    | -  | Chrome    | • | •   | -   |
| 466   | V584660018 | 2514648C1 | Right | Stainless | Remote | •    | -  | -         | • | •   | -   |
| 466   | V584660009 | 2514408C1 | Left  | Black     | Remote | •    | •  | -         | - | •   | •   |
| 466   | V584660110 | 2514645C1 | Right | Black     | Remote | •    | •  | Black     | - | •   | -   |
| 466   | V584660010 | 2514409C1 | Right | Black     | Remote | •    | •  | -         | - | •   | -   |
| 466   | V584660007 | 2514405C1 | Left  | Black     | Remote | •    | -  | -         | - | •   | •   |
| 466   | V584660108 | 2514407C1 | Right | Black     | Remote | •    | -  | Black     | - | •   | -   |
| 466   | V584660008 | 2514406C1 | Right | Black     | Remote | •    | -  | -         | - | •   | -   |
| 466   | V584660005 | 2514396C1 | Left  | Black     | Manual | •    | •  | -         | - | •   | •   |
| 466   | V584660106 | 2514398C1 | Right | Black     | Manual | •    | •  | Black     | - | •   | -   |
| 466   | V584660006 | 2514397C1 | Right | Black     | Manual | •    | •  | -         | - | •   | -   |
| 466   | V584660104 | 2514395C1 | Right | Black     | Manual | •    | -  | Black     | - | •   | -   |
| 466   | V584660003 | 2514393C1 | Left  | Black     | Manual | •    | -  | -         | - | •   | •   |
| 466   | V584660004 | 2514394C1 | Right | Black     | Manual | •    | -  | -         | - | •   | -   |
| 466   | V584660001 | 2514390C1 | Left  | Black     | Manual | -    | -  | -         | - | -   | •   |
| 466   | V584660102 | 2514392C1 | Right | Black     | Manual | -    | -  | Black     | - | -   | -   |
| 466   | V584660023 | 2514654C1 | Left  | Black     | Manual | -    | -  | -         | - | -   | -   |
| 466   | V584660002 | 2514391C1 | Right | Black     | Manual | -    | -  | -         | - | -   | -   |

**M/R** Manual / remote



Call the Velvac Sales Team: **800.783.8871** sales@velvac.com

© VELVAC INC. • 2405 South Calhoun Road • New Berlin, WI 53151-2709 • Toll Free: 800.783.8871 • Fax: 262.786.4101

### 466 System Continued

#### Flat Glass Housing Head adjustable. Order glass to make complete head

| Model | Part #     | O.E.M.     | Glass Size  | Side  | Color  | M/R    | Heat | Light |
|-------|------------|------------|-------------|-------|--------|--------|------|-------|
| 466   | V614660009 | 2514663C91 | 7½"w x 14"h | Left  | Chrome | Remote | •    | •     |
| 466   | V614660008 | 2514662C91 | 7½"w x 14"h | Right | Chrome | Remote | •    | •     |
| 466   | V614660007 | 2514661C91 | 7½"w x 14"h | Both  | Chrome | Manual | -    | -     |
| 466   | V614660006 | 2514660C91 | 7½"w x 14"h | Both  | Black  | Remote | -    | -     |
| 466   | V614660005 | 2514659C91 | 7½"w x 14"h | Both  | Black  | Manual | -    | -     |

#### Flat Glass Kit

| Model | Part #     | O.E.M.     | Glass Size  | Side | Color | M/R  | Heat |
|-------|------------|------------|-------------|------|-------|------|------|
| 466   | V614660001 | 2514655C91 | 7½"w x 14"h | Both | n/a   | Both | •    |

#### Convex Glass Housing Head adjustable. Order glass to make complete head

| Model | Part #     | O.E.M.     | Glass Size  | Side | Color  | M/R    | Heat | Light |
|-------|------------|------------|-------------|------|--------|--------|------|-------|
| 466   | V614660011 | 2514665C91 | 7¾"w x 6¾"h | Both | Chrome | Manual | •    | -     |
| 466   | V614660010 | 2514664C91 | 7¾"w x 6¾"h | Both | Black  | Manual | •    | -     |

#### Convex Glass Kit

| Model | Part #     | O.E.M.     | Glass Size  | Side | Color | M/R  | Heat |
|-------|------------|------------|-------------|------|-------|------|------|
| 466   | V614660002 | 2514656C91 | 7¾"w x 6¾"h | Both | n/a   | Both | •    |

#### Flat Mirror Actuator

| Model | Part #     | O.E.M.     | Side |
|-------|------------|------------|------|
| 466   | V614660004 | 2514658C91 | Both |

#### Flat Head Size

7⅞"w x 14⅜"h x 2¾"d

#### Convex Head Size

7¾"w x 7"h x 2¾"d

#### Convex Look Down Mirror (Optional) No mirror holder provided

| Model | Part #     | O.E.M.                   | Glass Size   | Side  | Color  | M/R    | Heat | Light |
|-------|------------|--------------------------|--------------|-------|--------|--------|------|-------|
| 360   | V563600260 | 2506220C91<br>2506220C92 | 10⅝"w x 6¼"h | Right | Chrome | Manual | -    | -     |
| 360   | V563600160 | -                        | 10⅝"w x 6¼"h | Right | Black  | Manual | -    | -     |

#### Accessories

##### • Marker Light Kit

Model 466 | Part # V614660003  
(OEM 2514657C91)

# MIRRORS

## INTERNATIONAL

### 404 System | DuraStar



#### Vehicle:

DuraStar 4100, 4200, 4200LP, 4300, 4300LP, 4400, 4400LP, 4700, 4700LP, 4700LPX, 4800, 4900, Hybrid, Mid-Cab (2002-Present)

- 1 1/8" tube

#### Head Adjustable

- Convex head size: 7 1/4" w x 7 1/4" h x 3" d

#### Glass Adjustable

- Convex head size: 8 7/16" w x 6 5/8" h x 4 1/2" d

#### Fender Bracket Assembly No head provided

| Model | Left Bracket # | Right Bracket # | Color     | Material  | Heat |
|-------|----------------|-----------------|-----------|-----------|------|
| 404   | V584049201     | V584049202      | Stainless | Stainless | -    |
| 404   | V584049211     | V584049212      | Black     | Steel     | -    |

#### Accessories

- **Head Clamp & Screw Kit**

Model 405 | Part # V624059999 (OEM 2507274C1)

#### Convex Glass Head Head adjustable

| Model | Part #     | O.E.M.    | Glass size          | Side | Color  | M/R    | Heat | Light |
|-------|------------|-----------|---------------------|------|--------|--------|------|-------|
| 388   | V563882208 | 2507272C1 | 6 3/4" w x 6 3/4" h | Both | Chrome | Manual | -    | -     |
| 409   | V564090013 | -         | 6 3/4" w x 6 3/4" h | Both | Black  | Manual | -    | -     |

#### Convex Glass Head Glass adjustable

| Model | Part #                  | Glass size          | Side | Color  | M/R    | Heat | Light |
|-------|-------------------------|---------------------|------|--------|--------|------|-------|
| 428   | V564281013 <sup>1</sup> | 7 3/4" w x 5 3/4" h | Both | Chrome | Manual | -    | -     |
| 428   | V564281001              | 7 3/4" w x 5 3/4" h | Both | Black  | Manual | -    | -     |

#### Convex Glass Kit

| Model   | Part #                  | O.E.M.    | Glass Size          | Side | Color | M/R    | Heat |
|---------|-------------------------|-----------|---------------------|------|-------|--------|------|
| 388/409 | V153882120              | 2507273C1 | 6 3/4" w x 6 3/4" h | Both | Black | Manual | -    |
| 428     | V154280001              | -         | 7 3/4" w x 5 3/4" h | Both | Black | Manual | -    |
| 428     | V614280008 <sup>2</sup> | -         | 7 3/4" w x 5 3/4" h | Both | Black | Manual | -    |

#### Convex Mirror Cover

| Model | Part #     | Side | Color  | Light |
|-------|------------|------|--------|-------|
| 428   | V134281015 | Both | Chrome | -     |
| 428   | V134281011 | Both | Black  | -     |

#### NOTES

**M/R** Manual / remote

\* Vertical bracket on Bracket Assembly is 3 13/16" longer (taller) than OEM standard bracket in order to accommodate either Head Adjustable or Glass Adjustable mirror options

<sup>1</sup> Chrome backcover with chrome housing

<sup>2</sup> Includes housing



Call the Velvac Sales Team: **800.783.8871** sales@velvac.com

© VELVAC INC. • 2405 South Calhoun Road • New Berlin, WI 53151-2709 • Toll Free: 800.783.8871 • Fax: 262.786.4101

LoneStar | **Standard Mirror** | **454 System**



Flat Glass Kit



Convex Glass Kit

### Vehicle:

LoneStar Daycab, Sleeper Cab, Harley (2008-Present)

- 5/16-18 UNC Thread both ends

### Flat Head Size

7¼" w x 15⅞" h x 3" d

### Convex Head Size

7¼" w x 7¼" h x 3" d

### Accessories

- **Marker Light Assembly**

Model 438 | Part # V084380005  
(OEM 2596753C91)

- **Marker Light Kit w/ Chrome Bezel**

Model 438 | Part # V614380005  
(OEM 2602168C1)

### Flat Glass Mirror Housing Head adjustable. Order glass to make complete head

| Model | Part #     | O.E.M.    | Glass Size    | Side  | Color     | M/R    | Heat | Light |
|-------|------------|-----------|---------------|-------|-----------|--------|------|-------|
| 438   | V514384544 | 2598604C1 | 6⅞" w x 16" h | Right | Stainless | Remote | •    | •     |
| 438   | V514384543 | 2598606C1 | 6⅞" w x 16" h | Left  | Stainless | Remote | •    | •     |

### Flat Glass Kit

| Model | Part #     | O.E.M.    | Glass Size    | Side | Color | M/R  | Heat |
|-------|------------|-----------|---------------|------|-------|------|------|
| 438   | V154382117 | 2595727C1 | 6⅞" w x 16" h | Both | Black | Both | •    |

### Convex Glass Housing Head adjustable. Order glass to make complete head

| Model | Part #     | O.E.M.    | Glass Size    | Color  | M/R    | Heat | Light |
|-------|------------|-----------|---------------|--------|--------|------|-------|
| 388   | V563882218 | 2598602C1 | 6¾" w x 6¾" h | Chrome | Manual | •    | -     |

### Convex Glass Kit

| Model | Part #     | O.E.M.    | Glass Size    | Side | Color | M/R    | Heat |
|-------|------------|-----------|---------------|------|-------|--------|------|
| 388   | V153882117 | 2598603C1 | 6¾" w x 6¾" h | Both | Black | Manual | •    |

### Convex Look Down Mirror (Optional) No mirror holder provided

| Model | Part #     | O.E.M.                   | Glass Size     | Side  | Color  | M/R    | Heat | Light |
|-------|------------|--------------------------|----------------|-------|--------|--------|------|-------|
| 360   | V563600260 | 2506220C91<br>2506220C92 | 10⅝" w x 6¼" h | Right | Chrome | Manual | -    | -     |

### NOTES

**M/R** Manual / remote

Bracket not available. Contact OE to purchase.

# MIRRORS

## INTERNATIONAL

425 System | Premium Mirror | LoneStar



Flat Glass Kit



Convex Glass Kit

### Head Size

9 1/8" w x 23 3/4" h x 6 1/8" d

### Vehicle:

LoneStar Daycab, Sleeper Cab,  
Harley (2008-Present)

- Fits 1 1/8" tube

### NOTES

- CB** Bracket assembly furnished with wiring harness for CB
- Look Down** Bracket assembly furnished with black or chrome look down mirror
- L** Bracket assembly furnished with wiring harness for convex (lower) mirror turn signal
- U** Bracket assembly furnished with wiring harness for lighted flat (upper) mirror
- U/L** Bracket assembly furnished with wiring harness for heated flat (upper) mirror and convex (lower) mirror

**M/R** Manual / remote

### Bracket Assemblies

| Model | Part #     | O.E.M.    | Side  | Color     | M/R    | Heat | CB | Look Down | L | U | U/L |
|-------|------------|-----------|-------|-----------|--------|------|----|-----------|---|---|-----|
| 425   | V584004021 | 2505300C4 | Left  | Black     | Manual | •    | •  | -         | - | • | •   |
| 425   | V584004630 | 2604799C1 | Right | Black     | Manual | •    | •  | -         | - | • | •   |
| 425   | V584004025 | -         | Left  | Black     | Remote | •    | -  | -         | - | • | •   |
| 425   | V584004026 | 2506299C3 | Right | Black     | Remote | •    | -  | -         | - | • | •   |
| 425   | V584004028 | 2505324C3 | Right | Black     | Remote | •    | -  | Black     | - | • | •   |
| 425   | V584004029 | 2505811C3 | Left  | Black     | Remote | •    | •  | -         | - | • | •   |
| 425   | V584004030 | 2506300C4 | Right | Black     | Remote | •    | •  | -         | - | • | •   |
| 425   | V584004032 | 2505302C4 | Right | Black     | Remote | •    | •  | Black     | - | • | •   |
| 425   | V584004624 | 2505812C3 | Right | Black     | Remote | •    | •  | Chrome    | - | • | •   |
| 425   | V584004525 | -         | Left  | Stainless | Manual | •    | -  | -         | - | • | •   |
| 425   | V584004526 | 2599424C1 | Right | Stainless | Manual | •    | -  | -         | - | • | •   |
| 425   | V584004528 | 2599423C1 | Right | Stainless | Manual | •    | -  | Chrome    | - | • | •   |
| 425   | V584004529 | 2599422C1 | Left  | Stainless | Manual | •    | •  | -         | - | • | •   |
| 425   | V584004530 | 2599426C1 | Right | Stainless | Manual | •    | •  | -         | - | • | •   |
| 425   | V584004532 | 2599427C1 | Right | Stainless | Manual | •    | •  | Chrome    | - | • | •   |
| 425   | V584004517 | 2505325C3 | Left  | Stainless | Remote | •    | -  | -         | - | • | •   |
| 425   | V584004518 | 2505326C3 | Right | Stainless | Remote | •    | -  | -         | - | • | •   |
| 425   | V584004520 | 2505303C3 | Right | Stainless | Remote | •    | -  | Chrome    | - | • | •   |
| 425   | V584004521 | 2506298C4 | Left  | Stainless | Remote | •    | •  | -         | - | • | •   |
| 425   | V584004522 | 2505305C4 | Right | Stainless | Remote | •    | •  | -         | - | • | •   |
| 425   | V584250544 | 2595636C1 | Right | Stainless | Remote | •    | •  | Black     | - | • | •   |
| 425   | V584004524 | 2505810C3 | Right | Stainless | Remote | •    | •  | Chrome    | - | • | •   |
| 425   | V584250541 | 2595634C1 | Left  | Stainless | Remote | •    | •  | -         | • | • | •   |
| 425   | V584250542 | 2595635C1 | Right | Stainless | Remote | •    | •  | -         | • | • | •   |
| 425   | V584250574 | 2595647C1 | Right | Stainless | Remote | •    | •  | Black     | • | • | •   |
| 425   | V584250554 | 2595644C1 | Right | Stainless | Remote | •    | •  | Chrome    | • | • | •   |



Call the Velvac Sales Team: **800.783.8871** sales@velvac.com

© VELVAC INC. • 2405 South Calhoun Road • New Berlin, WI 53151-2709 • Toll Free: 800.783.8871 • Fax: 262.786.4101

#### Flat Glass Kit

| Model | Part #     | O.E.M.                 | Glass Size   | Side | Color | M/R  | Heat |
|-------|------------|------------------------|--------------|------|-------|------|------|
| 400   | V154003107 | 2505818C1<br>2505818C2 | 7¼"w x 14⅞"h | Both | Black | Both | •    |
| 400   | V154003100 | 2505817C1<br>2505817C2 | 7¼"w x 14⅞"h | Both | Black | Both | -    |

#### Convex Glass Kit

| Model | Part #                  | O.E.M.                              | Glass Size | Side  | Color | Heat |
|-------|-------------------------|-------------------------------------|------------|-------|-------|------|
| 400   | V154003117              | 2505820C1<br>2505820C2<br>2505820C3 | 7"w x 6⅜"h | Both  | Black | •    |
| 400   | V154003110              | 2505819C1<br>2505819C2              | 7"w x 6⅜"h | Both  | Black | -    |
| 400   | V154004002 <sup>1</sup> | 2594622C91                          | 7"w x 6⅜"h | Right | Black | •    |
| 400   | V154004001 <sup>1</sup> | 2594621C91                          | 7"w x 6⅜"h | Left  | Black | •    |

#### Accessories

- **Clamp Kit, 3 EA**

Model 425 | Part # V614250010  
(OEM 2595657C91)

#### NOTES

<sup>1</sup> Furnished with turn signal

<sup>2</sup> Furnished with cable assembly for turn signal

<sup>3</sup> Furnished with cable assembly without turn signal

#### Flat Mirror Actuator

| Model | Part #                  | O.E.M.    | Side |
|-------|-------------------------|-----------|------|
| 425   | V094252591 <sup>2</sup> | 2595653C1 | Both |
| 425   | V094002590 <sup>3</sup> | 2592422C1 | Both |

#### Convex Look Down Mirror (Optional) *No mirror holder provided*

| Model | Part #     | O.E.M.                   | Glass Size   | Side  | Color  | M/R    | Heat | Light |
|-------|------------|--------------------------|--------------|-------|--------|--------|------|-------|
| 360   | V563600260 | 2506220C91<br>2506220C92 | 10⅝"w x 6¼"h | Right | Chrome | Manual | -    | -     |
| 360   | V563600160 | -                        | 10⅝"w x 6¼"h | Right | Black  | Manual | -    | -     |

## INTERNATIONAL

420 System | Aero Mirror | PayStar



Actuator

### Vehicle:

PayStar 5000, 5070, 5500, 5600, 5900SFA, 5900SBA, 9100, 9100i, 9200, 9200i, 9300, 9400, 9400i, 9600, 9700, 9800, 9900, 9900i, 9900ix (2005-Present)

- Fits 1 $\frac{1}{8}$ " tube

### Head Size

10 $\frac{1}{8}$ "w x 24 $\frac{1}{8}$ "h x 4 $\frac{1}{2}$ "d

### NOTES

Bracket, head and glass not available.  
Contact OE to purchase.

### Flat Mirror Actuator

| Model | Part #     | Side |
|-------|------------|------|
| 420   | V084200101 | Both |



Call the Velvac Sales Team: **800.783.8871** [sales@velvac.com](mailto:sales@velvac.com)

© VELVAC INC. • 2405 South Calhoun Road • New Berlin, WI 53151-2709 • Toll Free: 800.783.8871 • Fax: 262.786.4101





Flat Glass Head



Flat Glass Kit

### Vehicle:

PayStar 5000, 5070, 5500, 5600, 5900SFA, 5900SBA, 9100, 9100i, 9200, 9200i, 9300, 9400, 9400i, 9600, 9700, 9800, 9900, 9900i, 9900ix (2004-Present)

- 5/16-18 UNC Thread both ends

### Flat Head Size

7¼" w x 15⅞" h x 3" d

### Accessories

- **Marker Light Kit**

Model 421 | Part # V614210001  
(OEM 2596752C91)

### Flat Glass Head Head adjustable

| Model | Part #                  | O.E.M.                   | Glass Size    | Side  | Color     | M/R    | Heat | Light |
|-------|-------------------------|--------------------------|---------------|-------|-----------|--------|------|-------|
| 438   | V514380014 <sup>1</sup> | 2503919C92               | 6⅞" w x 16" h | Right | Stainless | Remote | •    | •     |
| 438   | V514380013 <sup>1</sup> | 2596749C91               | 6⅞" w x 16" h | Left  | Stainless | Remote | •    | •     |
| 438   | V514380012 <sup>1</sup> | 2503923C92               | 6⅞" w x 16" h | Right | Stainless | Remote | •    | -     |
| 438   | V514380011 <sup>1</sup> | 2596747C91               | 6⅞" w x 16" h | Left  | Stainless | Remote | •    | -     |
| 438   | V514380008              | 2596746C91               | 6⅞" w x 16" h | Right | Stainless | Manual | •    | •     |
| 438   | V514380007              | 2503920C92<br>2596745C91 | 6⅞" w x 16" h | Left  | Stainless | Manual | •    | •     |
| 438   | V514380006              | 2503924C92               | 6⅞" w x 16" h | Right | Stainless | Manual | •    | -     |
| 438   | V514380005              | 2503925C92<br>2596743C91 | 6⅞" w x 16" h | Left  | Stainless | Manual | •    | -     |

### Flat Glass Kit

| Model | Part #     | O.E.M.    | Glass Size    | Side | Color | M/R  | Heat |
|-------|------------|-----------|---------------|------|-------|------|------|
| 438   | V154382117 | 2595727C1 | 6⅞" w x 16" h | Both | Black | Both | •    |

### 8" Convex Mirror Assemblies Head adjustable

| Model | Part #     | O.E.M.    | Glass Size | Side | Color     | M/R    | Heat | Light |
|-------|------------|-----------|------------|------|-----------|--------|------|-------|
| 445   | V564451101 | 2507752C3 | 8⅞"        | Both | Stainless | Manual | -    | -     |

### NOTES

**M/R** Manual / remote

<sup>1</sup> Two-way adjustment

Bracket not available. Contact OE to purchase.

# MIRRORS

## INTERNATIONAL

405 System | Standard Mirror | ProStar



### Vehicle:

ProStar (2006-Present)

- Fits 1 - 1 1/8" tube

### Flat Head Size

8 3/16" w x 17 3/8" h x 4 3/8" d

### Convex Head Size

8 1/8" w x 8 1/8" h x 4 7/16" d

### NOTES

**CB** Bracket assembly furnished with wiring harness for CB

**Look Down** Bracket assembly furnished with black look down mirror

**U/L** Bracket assembly furnished with wiring harness for heated flat (upper) and convex (lower) mirrors

**M/R** Manual / remote

### Bracket Assemblies

| Model | Part #     | O.E.M.    | Side  | Color | M/R    | Heat | CB | Look Down | U/L |
|-------|------------|-----------|-------|-------|--------|------|----|-----------|-----|
| 405   | V584004001 | 2505274C3 | Left  | Black | Manual | -    | -  | -         | -   |
| 405   | V584004002 | 2505275C3 | Right | Black | Manual | -    | -  | -         | -   |
| 405   | V584004004 | 2505278C3 | Right | Black | Manual | -    | -  | •         | -   |
| 405   | V584004005 | 2505276C4 | Left  | Black | Manual | -    | •  | -         | -   |
| 405   | V584004006 | 2505277C4 | Right | Black | Manual | -    | •  | -         | -   |
| 405   | V584005009 | 2589149C2 | Left  | Black | Manual | •    | -  | -         | •   |
| 405   | V584005010 | 2589150C2 | Right | Black | Manual | •    | -  | -         | •   |
| 405   | V584005012 | 2589153C2 | Right | Black | Manual | •    | -  | •         | •   |
| 405   | V584005013 | 2589151C2 | Left  | Black | Manual | •    | •  | -         | •   |
| 405   | V584005014 | 2589152C2 | Right | Black | Manual | •    | •  | -         | •   |
| 405   | V584005016 | 2589154C2 | Right | Black | Manual | •    | •  | •         | •   |
| 405   | V584004046 | 2595651C1 | Right | Black | Remote | •    | -  | -         | •   |
| 405   | V584004048 | 2595652C1 | Right | Black | Remote | •    | -  | •         | •   |
| 405   | V584004033 | 2589844C1 | Left  | Black | Remote | •    | •  | -         | •   |
| 405   | V584004034 | 2589847C1 | Right | Black | Remote | •    | •  | -         | •   |



Call the Velvac Sales Team: **800.783.8871** sales@velvac.com

© VELVAC INC. • 2405 South Calhoun Road • New Berlin, WI 53151-2709 • Toll Free: 800.783.8871 • Fax: 262.786.4101

#### Flat Glass *Glass only*

| Model | Part #     | O.E.M.    | Glass Size                                                            | Side | Color | M/R  | Heat |
|-------|------------|-----------|-----------------------------------------------------------------------|------|-------|------|------|
| 405   | V404055800 | 2505814C2 | 7 <sup>5</sup> / <sub>8</sub> " w x 16 <sup>3</sup> / <sub>4</sub> "h | Both | n/a   | Both | •    |
| 405   | V404055700 | 2505813C2 | 7 <sup>5</sup> / <sub>8</sub> " w x 16 <sup>3</sup> / <sub>4</sub> "h | Both | n/a   | Both | -    |

#### Convex Glass *Glass only*

| Model | Part #     | O.E.M.    | Glass Size                                                          | Side | Color | M/R    | Heat |
|-------|------------|-----------|---------------------------------------------------------------------|------|-------|--------|------|
| 406   | V404065304 | 2505816C2 | 7 <sup>5</sup> / <sub>8</sub> "w x 7 <sup>5</sup> / <sub>8</sub> "h | Both | n/a   | Manual | •    |
| 406   | V404065204 | 2505815C2 | 7 <sup>5</sup> / <sub>8</sub> "w x 7 <sup>5</sup> / <sub>8</sub> "h | Both | n/a   | Manual | -    |

#### Convex Look Down Mirror (Optional) *No mirror holder provided*

| Model | Part #     | O.E.M.                   | Glass Size                                                           | Side  | Color  | M/R    | Heat | Light |
|-------|------------|--------------------------|----------------------------------------------------------------------|-------|--------|--------|------|-------|
| 360   | V563600260 | 2506220C91<br>2506220C92 | 10 <sup>5</sup> / <sub>8</sub> "w x 6 <sup>1</sup> / <sub>4</sub> "h | Right | Chrome | Manual | -    | -     |
| 360   | V563600160 | -                        | 10 <sup>5</sup> / <sub>8</sub> "w x 6 <sup>1</sup> / <sub>4</sub> "h | Right | Black  | Manual | -    | -     |

#### Accessories

- **Head Clamp & Screw Kit**  
Model 405 | Part # V624059999  
(OEM 2507274C1)

# MIRRORS

## INTERNATIONAL

425 System | Premium Mirror | ProStar



Flat Glass Kit



Convex Glass Kit

### Vehicle:

ProStar (2006-Present)

- Fits 1 1/8" tube

### Head Size

9 1/8" w x 23 3/4" h x 6 1/8" d

### NOTES

- CB** Bracket assembly furnished with wiring harness for CB
- Look Down** Bracket assembly furnished with black or chrome look down mirror
- L** Bracket assembly furnished with wiring harness for convex (lower) mirror turn signal
- U** Bracket assembly furnished with wiring harness for lighted flat (upper) mirror
- U/L** Bracket assembly furnished with wiring harness for heated flat (upper) and convex (lower) mirrors
- M/R** Manual / remote

### Bracket Assemblies

| Model | Part #     | O.E.M.    | Side  | Color     | M/R    | Heat | CB | Look Down | L | U | U/L |
|-------|------------|-----------|-------|-----------|--------|------|----|-----------|---|---|-----|
| 425   | V584004021 | 2505300C4 | Left  | Black     | Manual | -    | •  | -         | - | • | •   |
| 425   | V584004630 | 2604799C1 | Right | Black     | Manual | -    | •  | -         | - | • | •   |
| 425   | V584004025 | 2506299C3 | Left  | Black     | Remote | -    | -  | -         | - | • | •   |
| 425   | V584004026 | 2505324C3 | Right | Black     | Remote | -    | -  | -         | - | • | •   |
| 425   | V584004028 | 2505811C3 | Right | Black     | Remote | -    | -  | Black     | - | • | •   |
| 425   | V584004029 | 2506300C4 | Left  | Black     | Remote | •    | •  | -         | - | • | •   |
| 425   | V584004030 | 2505302C4 | Right | Black     | Remote | •    | •  | -         | - | • | •   |
| 425   | V584004032 | 2505812C3 | Right | Black     | Remote | •    | •  | Black     | - | • | •   |
| 425   | V584004624 | 2604803C1 | Right | Black     | Remote | •    | •  | Chrome    | - | • | •   |
| 425   | V584004525 | -         | Left  | Stainless | Manual | •    | -  | -         | - | • | •   |
| 425   | V584004526 | 2599424C1 | Right | Stainless | Manual | •    | -  | -         | - | • | •   |
| 425   | V584004528 | 2599423C1 | Right | Stainless | Manual | •    | -  | Chrome    | - | • | •   |
| 425   | V584004529 | 2599422C1 | Left  | Stainless | Manual | •    | •  | -         | - | • | •   |
| 425   | V584004530 | 2599426C1 | Right | Stainless | Manual | •    | •  | -         | - | • | •   |
| 425   | V584004532 | 2599427C1 | Right | Stainless | Manual | •    | •  | Chrome    | - | • | •   |
| 425   | V584004517 | 2505325C3 | Left  | Stainless | Remote | •    | -  | -         | - | • | •   |
| 425   | V584004518 | 2505326C3 | Right | Stainless | Remote | •    | -  | -         | - | • | •   |
| 425   | V584004520 | 2505303C3 | Right | Stainless | Remote | •    | -  | Chrome    | - | • | •   |
| 425   | V584004521 | 2506298C4 | Left  | Stainless | Remote | •    | •  | -         | - | • | •   |
| 425   | V584004522 | 2505305C4 | Right | Stainless | Remote | •    | •  | -         | - | • | •   |
| 425   | V584250544 | 2595636C1 | Right | Stainless | Remote | •    | •  | Black     | - | • | •   |
| 425   | V584004524 | 2505810C3 | Right | Stainless | Remote | •    | •  | Chrome    | - | • | •   |
| 425   | V584250541 | 2595634C1 | Left  | Stainless | Remote | •    | •  | -         | • | • | •   |
| 425   | V584250542 | 2595635C1 | Right | Stainless | Remote | •    | •  | -         | • | • | •   |
| 425   | V584250574 | 2595647C1 | Right | Stainless | Remote | •    | •  | Black     | • | • | •   |
| 425   | V584250554 | 2595644C1 | Right | Stainless | Remote | •    | •  | Chrome    | • | • | •   |



Call the Velvac Sales Team: **800.783.8871** sales@velvac.com

© VELVAC INC. • 2405 South Calhoun Road • New Berlin, WI 53151-2709 • Toll Free: 800.783.8871 • Fax: 262.786.4101

#### Flat Glass Kit

| Model | Part #     | O.E.M.                 | Glass Size    | Side | Color | M/R  | Heat |
|-------|------------|------------------------|---------------|------|-------|------|------|
| 400   | V154003107 | 2505818C1<br>2505818C2 | 7¼" w x 14⅞"h | Both | Black | Both | •    |
| 400   | V154003100 | 2505817C1<br>2505817C2 | 7¼" w x 14⅞"h | Both | Black | Both | -    |

#### Convex Glass Kit

| Model | Part #                  | O.E.M.                              | Glass Size  | Side  | Color | M/R    | Heat |
|-------|-------------------------|-------------------------------------|-------------|-------|-------|--------|------|
| 400   | V154003117              | 2505820C1<br>2505820C2<br>2505820C3 | 7" w x 6⅜"h | Both  | Black | Manual | •    |
| 400   | V154003110              | 2505819C1<br>2505819C2              | 7" w x 6⅜"h | Both  | Black | Manual | -    |
| 400   | V154004002 <sup>1</sup> | 2594622C91                          | 7" w x 6⅜"h | Right | Black | Manual | •    |
| 400   | V154004001 <sup>1</sup> | 2594621C91                          | 7" w x 6⅜"h | Left  | Black | Manual | •    |

#### Flat Mirror Actuator

| Model | Part #                  | O.E.M.    | Side |
|-------|-------------------------|-----------|------|
| 425   | V094252591 <sup>2</sup> | 2595653C1 | Both |
| 425   | V094002590 <sup>3</sup> | 2592422C1 | Both |

#### Accessories

##### • Clamp Kit, 3 EA

Model 425 | Part # V614250010  
(OEM 2595657C91)

#### Convex Look Down Mirror (Optional) *No mirror holder provided*

| Model | Part #     | O.E.M.                   | Glass Size     | Side  | Color  | M/R    | Heat | Light |
|-------|------------|--------------------------|----------------|-------|--------|--------|------|-------|
| 360   | V563600260 | 2506220C91<br>2506220C92 | 10⅝" w x 6¼" h | Right | Chrome | Manual | -    | -     |
| 360   | V563600160 | -                        | 10⅝" w x 6¼" h | Right | Black  | Manual | -    | -     |

#### NOTES

<sup>1</sup> Furnished with turn signal

<sup>2</sup> Furnished with cable assembly for turn signal

<sup>3</sup> Furnished with cable assembly without turn signal

# MIRRORS

## INTERNATIONAL

### 466 System | Universal Mirror | ProStar



Bracket Assemblies



Flat Glass Kit



Convex Glass Kit

#### Vehicle:

ProStar (2015-Present)

- Fits 1 - 1 1/8" tube

#### Flat Head Size

7 7/8" w x 14 3/8" h x 2 3/4" d

#### Convex Head Size

7 3/4" w x 7" h x 2 3/4" d

#### Bracket Assemblies

| Model | Part #     | O.E.M.    | Side  | Color     | M/R    | Heat | CB | Look Down | U | U/L | AAT |
|-------|------------|-----------|-------|-----------|--------|------|----|-----------|---|-----|-----|
| 466   | V584660019 | 2514650C1 | Left  | Stainless | Remote | •    | •  | -         | • | •   | •   |
| 466   | V584660120 | 2514652C1 | Right | Stainless | Remote | •    | •  | Chrome    | • | •   | -   |
| 466   | V584660020 | 2514651C1 | Right | Stainless | Remote | •    | •  | -         | • | •   | -   |
| 466   | V584660017 | 2514647C1 | Left  | Stainless | Remote | •    | -  | -         | • | •   | •   |
| 466   | V584660118 | 2514649C1 | Right | Stainless | Remote | •    | -  | Chrome    | • | •   | -   |
| 466   | V584660018 | 2514648C1 | Right | Stainless | Remote | •    | -  | -         | • | •   | -   |
| 466   | V584660009 | 2514408C1 | Left  | Black     | Remote | •    | •  | -         | - | •   | •   |
| 466   | V584660110 | 2514645C1 | Right | Black     | Remote | •    | •  | Black     | - | •   | -   |
| 466   | V584660010 | 2514409C1 | Right | Black     | Remote | •    | •  | -         | - | •   | -   |
| 466   | V584660007 | 2514405C1 | Left  | Black     | Remote | •    | -  | -         | - | •   | •   |
| 466   | V584660108 | 2514407C1 | Right | Black     | Remote | •    | -  | Black     | - | •   | -   |
| 466   | V584660008 | 2514406C1 | Right | Black     | Remote | •    | -  | -         | - | •   | -   |
| 466   | V584660005 | 2514396C1 | Left  | Black     | Manual | •    | •  | -         | - | •   | •   |
| 466   | V584660106 | 2514398C1 | Right | Black     | Manual | •    | •  | Black     | - | •   | -   |
| 466   | V584660006 | 2514397C1 | Right | Black     | Manual | •    | •  | -         | - | •   | -   |
| 466   | V584660104 | 2514395C1 | Right | Black     | Manual | •    | -  | Black     | - | •   | -   |
| 466   | V584660003 | 2514393C1 | Left  | Black     | Manual | •    | -  | -         | - | •   | •   |
| 466   | V584660004 | 2514394C1 | Right | Black     | Manual | •    | -  | -         | - | •   | -   |
| 466   | V584660001 | 2514390C1 | Left  | Black     | Manual | -    | -  | -         | - | -   | •   |
| 466   | V584660102 | 2514392C1 | Right | Black     | Manual | -    | -  | Black     | - | -   | -   |
| 466   | V584660023 | 2514654C1 | Left  | Black     | Manual | -    | -  | -         | - | -   | -   |
| 466   | V584660002 | 2514391C1 | Right | Black     | Manual | -    | -  | -         | - | -   | -   |



Call the Velvac Sales Team: **800.783.8871** sales@velvac.com

© VELVAC INC. • 2405 South Calhoun Road • New Berlin, WI 53151-2709 • Toll Free: 800.783.8871 • Fax: 262.786.4101

#### Flat Glass Housing Head adjustable. Order glass to make complete head

| Model | Part #     | O.E.M.     | Glass Size  | Side  | Color  | M/R    | Heat | Light |
|-------|------------|------------|-------------|-------|--------|--------|------|-------|
| 466   | V614660009 | 2514663C91 | 7½"w x 14"h | Left  | Chrome | Remote | Both | •     |
| 466   | V614660008 | 2514662C91 | 7½"w x 14"h | Right | Chrome | Remote | Both | •     |
| 466   | V614660007 | 2514661C91 | 7½"w x 14"h | Both  | Chrome | Manual | Both | -     |
| 466   | V614660006 | 2514660C91 | 7½"w x 14"h | Both  | Black  | Remote | Both | -     |
| 466   | V614660005 | 2514659C91 | 7½"w x 14"h | Both  | Black  | Manual | Both | -     |

#### Flat Glass Kit

| Model | Part #     | O.E.M.     | Glass Size  | Side | Color | M/R  | Heat |
|-------|------------|------------|-------------|------|-------|------|------|
| 466   | V614660001 | 2514655C91 | 7½"w x 14"h | Both | n/a   | Both | •    |

#### Convex Glass Housing Head adjustable. Order glass to make complete head

| Model | Part #     | O.E.M.     | Glass Size  | Color  | M/R    | Heat | Light |
|-------|------------|------------|-------------|--------|--------|------|-------|
| 466   | V614660011 | 2514665C91 | 7¾"w x 6¾"h | Chrome | Manual | •    | -     |
| 466   | V614660010 | 2514664C91 | 7¾"w x 6¾"h | Black  | Manual | •    | -     |

#### Convex Glass Kit

| Model | Part #     | O.E.M.     | Glass Size  | Side | Color | M/R    | Heat |
|-------|------------|------------|-------------|------|-------|--------|------|
| 466   | V614660002 | 2514656C91 | 7¾"w x 6¾"h | Both | n/a   | Manual | •    |

#### Flat Mirror Actuator

| Model | Part #     | O.E.M.     | Side |
|-------|------------|------------|------|
| 466   | V614660004 | 2514658C91 | Both |

#### Accessories

##### • Marker Light Kit

Model 466 | Part # V614660003  
(OEM 2514657C91)

#### Convex Look Down Mirror (Optional) No mirror holder provided

| Model | Part #     | O.E.M.                   | Glass Size   | Color  | M/R    | Heat | Light |
|-------|------------|--------------------------|--------------|--------|--------|------|-------|
| 360   | V563600260 | 2506220C91<br>2506220C92 | 10⅝"w x 6¼"h | Chrome | Manual | -    | -     |
| 360   | V563600160 | -                        | 10⅝"w x 6¼"h | Black  | Manual | -    | -     |

#### NOTES

- CB** Bracket assembly furnished with wiring harness for CB
- Look Down** Bracket assembly furnished with black or chrome look down mirror
- U** Bracket assembly furnished with wiring harness for lighted flat (upper) mirror
- U/L** Bracket assembly furnished with wiring harness for heated flat (upper) and convex (lower) mirrors
- AAT** Bracket assembly furnished with wiring harness for AAT sensor
- M/R** Manual / remote

# MIRRORS

## INTERNATIONAL

### 404 System | ProStar



### Vehicle:

ProStar (2006-Present)

- 1 1/8" tube

### Head Adjustable

- Convex head size:  
7 1/4"w x 7 1/4"h x 3"d
- Mirror size: 6 3/4"w x 6 3/4"h

### Glass Adjustable

- Convex head size:  
8 7/16"w x 6 5/8"h x 4 1/2"d
- Mirror size: 7 3/4"w x 5 3/4"h

### Accessories

- **Head Clamp & Screw Kit**

Model 405 | Part # V624059999  
(OEM 2507274C1)

### Fender Bracket Assembly *No head provided*

| Model | Left Bracket # | Right Bracket # | Color     | Material  | Heat |
|-------|----------------|-----------------|-----------|-----------|------|
| 404   | V584049001     | V584049002      | Stainless | Stainless | -    |
| 404   | V584049011     | V584049012      | Black     | Steel     | -    |

### Convex Glass Head *Head adjustable*

| Model | Part #     | O.E.M.    | Glass Size        | Side | Color  | M/R    | Heat | Light |
|-------|------------|-----------|-------------------|------|--------|--------|------|-------|
| 388   | V563882208 | 2507272C1 | 6 3/4"w x 6 3/4"h | Both | Chrome | Manual | -    | -     |
| 409   | V564090013 | -         | 6 3/4"w x 6 3/4"h | Both | Black  | Manual | -    | -     |

### Convex Glass Head *Glass adjustable*

| Model | Part #                  | Glass Size        | Side | Color  | M/R    | Heat | Light |
|-------|-------------------------|-------------------|------|--------|--------|------|-------|
| 428   | V564281013 <sup>1</sup> | 7 3/4"w x 5 3/4"h | Both | Chrome | Manual | -    | -     |
| 428   | V564281001              | 7 3/4"w x 5 3/4"h | Both | Black  | Manual | -    | -     |

### Convex Glass Kit

| Model   | Part #                  | O.E.M.    | Glass Size        | Side | Color | M/R    | Heat |
|---------|-------------------------|-----------|-------------------|------|-------|--------|------|
| 388/409 | V153882120              | 2507273C1 | 6 3/4"w x 6 3/4"h | Both | Black | Manual | -    |
| 428     | V154280001              | -         | 7 3/4"w x 5 3/4"h | Both | Black | Manual | -    |
| 428     | V614280008 <sup>2</sup> | -         | 7 3/4"w x 5 3/4"h | Both | Black | Manual | -    |

### Convex Mirror Cover

| Model | Part #     | Side | Color  | Light |
|-------|------------|------|--------|-------|
| 428   | V134281015 | Both | Chrome | -     |
| 428   | V134281011 | Both | Black  | -     |

### NOTES

**M/R** Manual / remote

\*Vertical bracket on Bracket Assembly is 1 9/16" longer (taller) than OEM standard bracket, in order to accommodate either Head Adjustable or Glass Adjustable mirror options

<sup>1</sup> Chrome backcover with chrome housing

<sup>2</sup> Includes housing



Call the Velvac Sales Team: **800.783.8871** sales@velvac.com

© VELVAC INC. • 2405 South Calhoun Road • New Berlin, WI 53151-2709 • Toll Free: 800.783.8871 • Fax: 262.786.4101



S-Series | **West Coast Mirrors**



*International plug*

**Vehicle:**

S-series and other trucks

**Housing Size**

- 7" x 16" aluminum head
- Order 713198 loop and bracket kit separately

**West Coast Mirror Head**

| Part # | Fletridge Part # | Navistar Part #          | Cham-Cal Part # | Side  | Heat |
|--------|------------------|--------------------------|-----------------|-------|------|
| 708335 | MIR4070          | 1657021C91<br>1657048C91 | 20000           | Both  | -    |
| 708336 | MIR4071          | 1667899C91               | 20090           | Right | •    |
| 708337 | MIR4074          | 1669515C91               | 20080           | Left  | •    |

**Loop and Bracket Assembly**

| Part # | Description               |
|--------|---------------------------|
| 713198 | Loop and bracket assembly |

# MIRRORS

## INTERNATIONAL

405 System | Standard Mirror | TerraStar

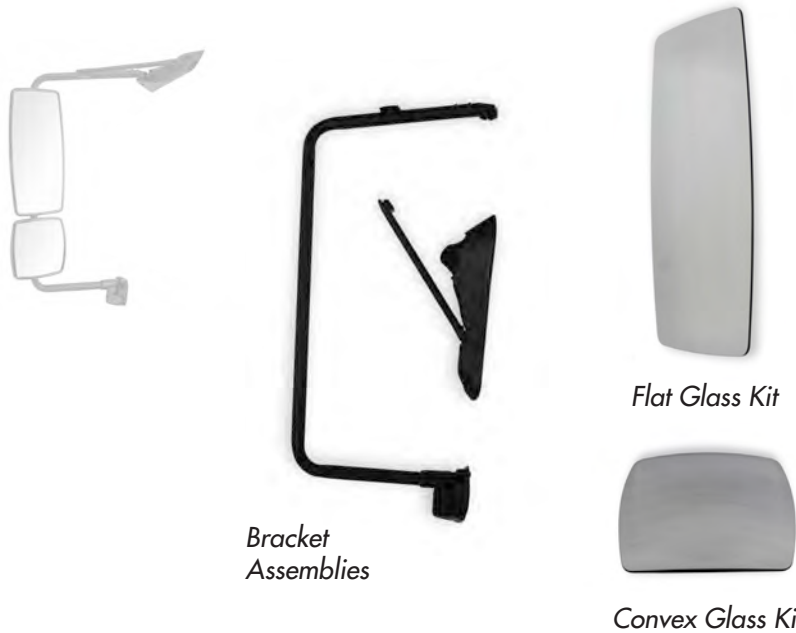

### Vehicle:

TerraStar Class 4/5 (2010-Present)

- Fits 1 - 1 1/8" tube

### Flat Head Size

8 3/16" w x 17 3/8" h x 4 3/8" d

### Convex Head Size

8 1/8" w x 8 1/8" h x 4 7/16" d

### NOTES

**CB** Bracket assembly furnished with wiring harness for CB

**Look Down** Bracket assembly furnished with black look down mirror

**U/L** Bracket assembly furnished with wiring harness for heated flat (upper) and convex (lower) mirrors

**M/R** Manual / remote

### Bracket Assemblies

| Model | Part #     | O.E.M.    | Side  | Color | M/R    | Heat | CB | Look Down | U/L |
|-------|------------|-----------|-------|-------|--------|------|----|-----------|-----|
| 405   | V584004001 | 2505274C3 | Left  | Black | Manual | -    | -  | -         | -   |
| 405   | V584004002 | 2505275C3 | Right | Black | Manual | -    | -  | -         | -   |
| 405   | V584004004 | 2505278C3 | Right | Black | Manual | -    | -  | •         | -   |
| 405   | V584004005 | 2505276C4 | Left  | Black | Manual | -    | •  | -         | -   |
| 405   | V584004006 | 2505277C4 | Right | Black | Manual | -    | •  | -         | -   |
| 405   | V584005009 | 2589149C2 | Left  | Black | Manual | •    | -  | -         | •   |
| 405   | V584005010 | 2589150C2 | Right | Black | Manual | •    | -  | -         | •   |
| 405   | V584005012 | 2589153C2 | Right | Black | Manual | •    | -  | •         | •   |
| 405   | V584005013 | 2589151C2 | Left  | Black | Manual | •    | •  | -         | •   |
| 405   | V584005014 | 2589152C2 | Right | Black | Manual | •    | •  | -         | •   |
| 405   | V584005016 | 2589154C2 | Right | Black | Manual | •    | •  | •         | •   |
| 405   | V584004046 | 2595651C1 | Right | Black | Remote | •    | -  | -         | •   |
| 405   | V584004048 | 2595652C1 | Right | Black | Remote | •    | -  | •         | •   |
| 405   | V584004033 | 2589844C1 | Left  | Black | Remote | •    | •  | -         | •   |
| 405   | V584004034 | 2589847C1 | Right | Black | Remote | •    | •  | -         | •   |



Call the Velvac Sales Team: **800.783.8871** sales@velvac.com

© VELVAC INC. • 2405 South Calhoun Road • New Berlin, WI 53151-2709 • Toll Free: 800.783.8871 • Fax: 262.786.4101

#### Flat Glass Kit *Glass only*

| Model | Part #     | O.E.M.    | Glass Size                                                            | Side | Color | M/R  | Heat |
|-------|------------|-----------|-----------------------------------------------------------------------|------|-------|------|------|
| 405   | V404055800 | 2505814C2 | 7 <sup>5</sup> / <sub>8</sub> " w x 16 <sup>3</sup> / <sub>4</sub> "h | Both | n/a   | Both | •    |
| 405   | V404055700 | 2505813C2 | 7 <sup>5</sup> / <sub>8</sub> " w x 16 <sup>3</sup> / <sub>4</sub> "h | Both | n/a   | Both | -    |

#### Convex Glass Kit *Glass only*

| Model | Part #     | O.E.M.    | Glass Size                                                           | Side | Color | M/R    | Heat |
|-------|------------|-----------|----------------------------------------------------------------------|------|-------|--------|------|
| 406   | V404065304 | 2505816C2 | 7 <sup>5</sup> / <sub>8</sub> " w x 7 <sup>5</sup> / <sub>8</sub> "h | Both | n/a   | Manual | •    |
| 406   | V404065204 | 2505815C2 | 7 <sup>5</sup> / <sub>8</sub> " w x 7 <sup>5</sup> / <sub>8</sub> "h | Both | n/a   | Manual | -    |

#### Convex Look Down Mirror (Optional) *No mirror holder provided*

| Model | Part #     | O.E.M.                   | Glass Size                                                            | Side  | Color  | M/R    | Heat | Light |
|-------|------------|--------------------------|-----------------------------------------------------------------------|-------|--------|--------|------|-------|
| 360   | V563600260 | 2506220C91<br>2506220C92 | 10 <sup>5</sup> / <sub>8</sub> " w x 6 <sup>1</sup> / <sub>4</sub> "h | Right | Chrome | Manual | -    | -     |
| 360   | V563600160 | -                        | 10 <sup>5</sup> / <sub>8</sub> " w x 6 <sup>1</sup> / <sub>4</sub> "h | Right | Black  | Manual | -    | -     |

#### Accessories

- **Head Clamp & Screw Kit**

Model 405 | Part # V624059999  
(OEM 2507274C1)

# MIRRORS

## INTERNATIONAL

463 System | Standard Mirror | TerraStar

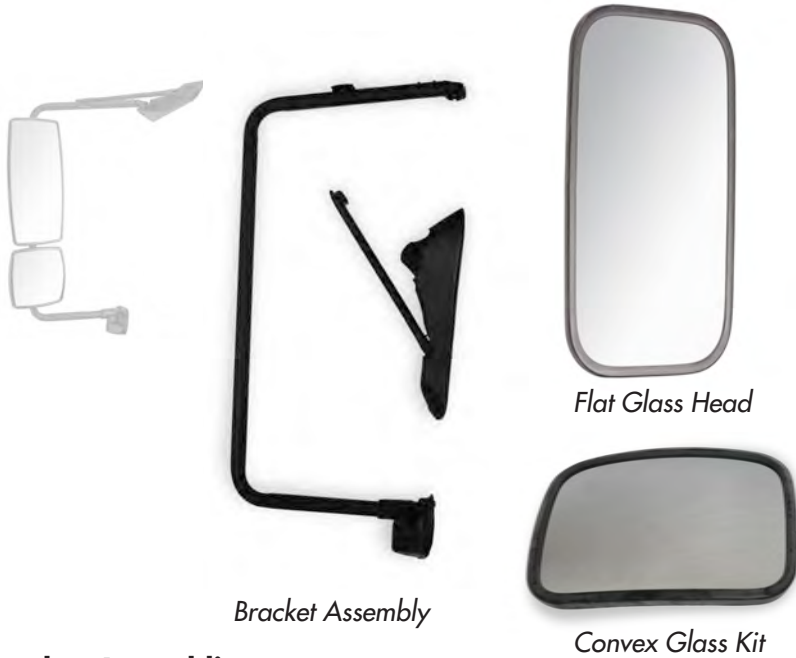

### Vehicle:

TerraStar Class 4/5 (2010-Present)

- Fits 1 - 1 1/8" tube

### Flat Head Size

7 1/4"w x 12 3/8"h x 3 1/2"d

### Convex Head Size

8 7/8"w x 6 7/8"h x 4 1/8"d

### Accessories

- **Head Clamp & Screw Kit**

Model 405 | Part # V624059999  
(OEM 2507274C1)

### NOTES

**M/R** Manual / remote

### Bracket Assemblies

| Model | Part #     | O.E.M.    | Side  | Color | M/R    | Heat |
|-------|------------|-----------|-------|-------|--------|------|
| 463   | V584004001 | 2505274C3 | Left  | Black | Manual | -    |
| 463   | V584004002 | 2505275C3 | Right | Black | Manual | -    |

### Flat Glass Head *Head adjustable*

| Model | Part #     | O.E.M.    | Glass Size     | Side | Color | M/R    | Heat | Light |
|-------|------------|-----------|----------------|------|-------|--------|------|-------|
| 408   | V514080002 | 2588800C2 | 6 3/4"w x 12"h | Both | Black | Manual | -    | -     |

### Convex Glass Head *Head adjustable*

| Model | Part #     | O.E.M.    | Glass Size | Side | Color | M/R    | Heat | Light |
|-------|------------|-----------|------------|------|-------|--------|------|-------|
| 408   | V564080002 | 2588801C2 | 8"w x 6"h  | Both | Black | Manual | -    | -     |



Call the Velvac Sales Team: **800.783.8871** [sales@velvac.com](mailto:sales@velvac.com)

© VELVAC INC. • 2405 South Calhoun Road • New Berlin, WI 53151-2709 • Toll Free: 800.783.8871 • Fax: 262.786.4101

TerraStar | Premium Mirror | 400 System



Flat Glass Kit



Convex Glass Kit

### Vehicle:

TerraStar Class 4/5 (2010-Present)

- Fits 1 - 1 1/8" tube

### Head Size

8 3/4" w x 24 3/4" h x 5 3/8" d

### NOTES

- CB** Bracket assembly furnished with wiring harness for CB
- Look Down** Bracket assembly furnished with black or chrome look down mirror
- U** Bracket assembly furnished with wiring harness for lighted flat (upper) mirror
- U/L** Bracket assembly furnished with wiring harness for heated flat (upper) and convex (lower) mirrors
- M/R** Manual / remote

### 102 Inch Wide Bracket Assemblies

| Model | Part #     | O.E.M.    | Side  | Color     | M/R    | Heat | CB | Look Down | U | U/L |
|-------|------------|-----------|-------|-----------|--------|------|----|-----------|---|-----|
| 400   | V584004025 | 2506299C3 | Left  | Black     | Remote | •    | -  | -         | • | •   |
| 400   | V584004026 | 2505324C3 | Right | Black     | Remote | •    | -  | -         | • | •   |
| 400   | V584004028 | 2505811C3 | Right | Black     | Remote | •    | -  | Black     | • | •   |
| 400   | V584004029 | 2506300C4 | Left  | Black     | Remote | •    | •  | -         | • | •   |
| 400   | V584004030 | 2505302C4 | Right | Black     | Remote | •    | •  | -         | • | •   |
| 400   | V584004032 | 2505812C3 | Right | Black     | Remote | •    | •  | Black     | • | •   |
| 400   | V584004501 | 2505320C3 | Left  | Stainless | Manual | -    | -  | -         | - | -   |
| 400   | V584004502 | 2505321C3 | Right | Stainless | Manual | -    | -  | -         | - | -   |
| 400   | V584004504 | 2505301C3 | Right | Stainless | Manual | -    | -  | Chrome    | - | -   |
| 400   | V584004505 | 2505296C4 | Left  | Stainless | Manual | -    | •  | -         | - | -   |
| 400   | V584004506 | 2505298C4 | Right | Stainless | Manual | -    | •  | -         | - | -   |
| 400   | V584004509 | 2509017C3 | Left  | Stainless | Manual | •    | -  | -         | • | •   |
| 400   | V584004526 | 2599424C1 | Right | Stainless | Manual | •    | -  | -         | • | •   |
| 400   | V584004528 | 2599423C1 | Right | Stainless | Manual | •    | -  | Chrome    | • | •   |
| 400   | V584004513 | 2505304C4 | Left  | Stainless | Manual | •    | •  | -         | • | •   |
| 400   | V584004530 | 2599426C1 | Right | Stainless | Manual | •    | •  | -         | • | •   |
| 400   | V584004532 | 2599427C1 | Right | Stainless | Manual | •    | •  | Chrome    | • | •   |
| 400   | V584004517 | 2505325C3 | Left  | Stainless | Remote | •    | -  | -         | • | •   |
| 400   | V584004518 | 2505326C3 | Right | Stainless | Remote | •    | -  | -         | • | •   |
| 400   | V584004520 | 2505303C3 | Right | Stainless | Remote | •    | -  | Chrome    | • | •   |
| 400   | V584004521 | 2506298C4 | Left  | Stainless | Remote | •    | •  | -         | • | •   |
| 400   | V584004522 | 2505305C4 | Right | Stainless | Remote | •    | •  | -         | • | •   |
| 400   | V584004524 | 2505810C3 | Right | Stainless | Remote | •    | •  | Chrome    | • | •   |

## INTERNATIONAL

### 400 System

Continued

#### 96 Inch Wide Bracket Assemblies

| Model | Part #     | O.E.M.    | Side  | Color     | M/R    | Heat | U | U/L |
|-------|------------|-----------|-------|-----------|--------|------|---|-----|
| 400   | V584004535 | 2596626C1 | Left  | Stainless | Remote | •    | • | •   |
| 400   | V584004536 | 2589850C1 | Right | Stainless | Remote | •    | • | •   |

#### Flat Glass Kit

| Model | Part #     | O.E.M.                 | Glass Size   | Side | Color | M/R  | Heat |
|-------|------------|------------------------|--------------|------|-------|------|------|
| 400   | V154003107 | 2505818C1<br>2505818C2 | 7¼"w x 14⅞"h | Both | Black | Both | •    |
| 400   | V154003100 | 2505817C1<br>2505817C2 | 7¼"w x 14⅞"h | Both | Black | Both | -    |

#### Convex Glass Kit

| Model | Part #                  | O.E.M.                              | Glass Size | Side  | Color | M/R    | Heat |
|-------|-------------------------|-------------------------------------|------------|-------|-------|--------|------|
| 400   | V154003117              | 2505820C1<br>2505820C2<br>2505820C3 | 7"w x 6⅜"h | Both  | Black | Manual | •    |
| 400   | V154003110              | 2505819C1<br>2505819C2              | 7"w x 6⅜"h | Both  | Black | Manual | -    |
| 400   | V154004002 <sup>1</sup> | 2594622C91                          | 7"w x 6⅜"h | Right | Black | Manual | •    |
| 400   | V154004001 <sup>1</sup> | 2594621C91                          | 7"w x 6⅜"h | Left  | Black | Manual | •    |

#### Flat Mirror Actuators

| Model | Part #                  | O.E.M.    | Side |
|-------|-------------------------|-----------|------|
| 400   | V094002590 <sup>2</sup> | 2592422C1 | Both |
| 425   | V094252591 <sup>3</sup> | 2595653C1 | Both |

#### Accessories

- **CB Antenna Holder Assembly**  
Model 400 | Part # V084002002  
(OEM 2506242C92)
- **Replacement CB Harness**  
Model 400 | Part # V084000100  
(OEM 2506241C91)

#### Convex Look Down Mirror (Optional) *No mirror holder provided*

| Model | Part #     | O.E.M.                   | Glass Size   | Side  | Color  | M/R    | Heat | Light |
|-------|------------|--------------------------|--------------|-------|--------|--------|------|-------|
| 360   | V563600260 | 2506220C91<br>2506220C92 | 10⅝"w x 6¼"h | Right | Chrome | Manual | -    | -     |
| 360   | V563600160 | -                        | 10⅝"w x 6¼"h | Right | Black  | Manual | -    | -     |

- **Head Clamp & Screw Kit**  
Model 400 | Part # V614000010  
(OEM 2506236C91)

#### NOTES

- <sup>1</sup> Furnished with turn signal
- <sup>2</sup> Furnished with cable assembly without turn signal
- <sup>3</sup> Furnished with cable assembly for turn signal



Call the Velvac Sales Team: **800.783.8871** sales@velvac.com

© VELVAC INC. • 2405 South Calhoun Road • New Berlin, WI 53151-2709 • Toll Free: 800.783.8871 • Fax: 262.786.4101

TerraStar | Premium Mirror | 466 System



Flat Glass



Convex Glass

Bracket Assemblies

### Vehicle:

TerraStar Class 4/5 (2015-Present)

- Fits 1 - 1 $\frac{1}{8}$ " tube

### Flat Head Size

7 $\frac{7}{8}$ "w x 14 $\frac{3}{8}$ "h x 2 $\frac{3}{4}$ "d

### Convex Head Size

7 $\frac{3}{4}$ "w x 7"h x 2 $\frac{3}{4}$ "d

### Bracket Assemblies

| Model | Part #     | O.E.M.    | Side  | Color     | M/R    | Heat | CB | Look Down | U | U/L | AAT |
|-------|------------|-----------|-------|-----------|--------|------|----|-----------|---|-----|-----|
| 466   | V584660019 | 2514650C1 | Left  | Stainless | Remote | •    | •  | -         | • | •   | •   |
| 466   | V584660120 | 2514652C1 | Right | Stainless | Remote | •    | •  | Chrome    | • | •   | -   |
| 466   | V584660020 | 2514651C1 | Right | Stainless | Remote | •    | •  | -         | • | •   | -   |
| 466   | V584660017 | 2514647C1 | Left  | Stainless | Remote | •    | -  | -         | • | •   | •   |
| 466   | V584660118 | 2514649C1 | Right | Stainless | Remote | •    | -  | Chrome    | • | •   | -   |
| 466   | V584660018 | 2514648C1 | Right | Stainless | Remote | •    | -  | -         | • | •   | -   |
| 466   | V584660009 | 2514408C1 | Left  | Black     | Remote | •    | •  | -         | - | •   | •   |
| 466   | V584660110 | 2514645C1 | Right | Black     | Remote | •    | •  | Black     | - | •   | -   |
| 466   | V584660010 | 2514409C1 | Right | Black     | Remote | •    | •  | -         | - | •   | -   |
| 466   | V584660007 | 2514405C1 | Left  | Black     | Remote | •    | -  | -         | - | •   | •   |
| 466   | V584660108 | 2514407C1 | Right | Black     | Remote | •    | -  | Black     | - | •   | -   |
| 466   | V584660008 | 2514406C1 | Right | Black     | Remote | •    | -  | -         | - | •   | -   |
| 466   | V584660005 | 2514396C1 | Left  | Black     | Manual | •    | •  | -         | - | •   | •   |
| 466   | V584660106 | 2514398C1 | Right | Black     | Manual | •    | •  | Black     | - | •   | -   |
| 466   | V584660006 | 2514397C1 | Right | Black     | Manual | •    | •  | -         | - | •   | -   |
| 466   | V584660104 | 2514395C1 | Right | Black     | Manual | •    | -  | Black     | - | •   | -   |
| 466   | V584660003 | 2514393C1 | Left  | Black     | Manual | •    | -  | -         | - | •   | •   |
| 466   | V584660004 | 2514394C1 | Right | Black     | Manual | •    | -  | -         | - | •   | -   |
| 466   | V584660001 | 2514390C1 | Left  | Black     | Manual | -    | -  | -         | - | -   | •   |
| 466   | V584660102 | 2514392C1 | Right | Black     | Manual | -    | -  | Black     | - | -   | -   |
| 466   | V584660023 | 2514654C1 | Left  | Black     | Manual | -    | -  | -         | - | -   | -   |
| 466   | V584660002 | 2514391C1 | Right | Black     | Manual | -    | -  | -         | - | -   | -   |

### NOTES

- CB** Bracket assembly furnished with wiring harness for CB
- Look Down** Bracket assembly furnished with black or chrome look down mirror
- U** Bracket assembly furnished with wiring harness lighted flat (upper) mirror

- U/L** Bracket assembly furnished with wiring harness for heated flat (upper) and convex (lower) mirrors
- AAT** Bracket assembly furnished with wiring harness for AAT sensor
- M/R** Manual / remote

## INTERNATIONAL

### 466 System

Continued

#### Accessories

##### • Marker Light Kit

Model 466 | Part # V614660003  
(OEM 2514657C91)

#### Flat Glass Housing Head adjustable. Order glass to make complete head

| Model | Part #     | O.E.M.     | Glass Size  | Side  | Color  | M/R    | Heat | Light |
|-------|------------|------------|-------------|-------|--------|--------|------|-------|
| 466   | V614660009 | 2514663C91 | 7½"w x 14"h | Left  | Chrome | Remote | Both | •     |
| 466   | V614660008 | 2514662C91 | 7½"w x 14"h | Right | Chrome | Remote | Both | •     |
| 466   | V614660007 | 2514661C91 | 7½"w x 14"h | Both  | Chrome | Manual | Both | -     |
| 466   | V614660006 | 2514660C91 | 7½"w x 14"h | Both  | Black  | Remote | Both | -     |
| 466   | V614660005 | 2514659C91 | 7½"w x 14"h | Both  | Black  | Manual | Both | -     |

#### Flat Glass Kit

| Model | Part #     | O.E.M.     | Glass Size  | Side | Color | M/R  | Heat |
|-------|------------|------------|-------------|------|-------|------|------|
| 466   | V614660001 | 2514655C91 | 7½"w x 14"h | Both | n/a   | Both | •    |

#### Convex Glass Housing Head adjustable. Order glass to make complete head

| Model | Part #     | O.E.M.     | Glass Size  | Color  | M/R    | Heat | Light |
|-------|------------|------------|-------------|--------|--------|------|-------|
| 466   | V614660011 | 2514665C91 | 7⅜"w x 6¾"h | Chrome | Manual | •    | -     |
| 466   | V614660010 | 2514664C91 | 7⅜"w x 6¾"h | Black  | Manual | •    | -     |

#### Convex Glass Kit

| Model | Part #     | O.E.M.     | Glass Size  | Side | Color | M/R    | Heat |
|-------|------------|------------|-------------|------|-------|--------|------|
| 466   | V614660002 | 2514656C91 | 7⅜"w x 6¾"h | Both | n/a   | Manual | •    |

#### Flat Mirror Actuator

| Model | Part #     | O.E.M.     | Side |
|-------|------------|------------|------|
| 466   | V614660004 | 2514658C91 | Both |

#### Convex Look Down Mirror (Optional) No mirror holder provided

| Model | Part #     | O.E.M.                   | Glass Size   | Side  | Color  | M/R    | Heat | Light |
|-------|------------|--------------------------|--------------|-------|--------|--------|------|-------|
| 360   | V563600260 | 2506220C91<br>2506220C92 | 10⅝"w x 6¼"h | Right | Chrome | Manual | -    | -     |
| 360   | V563600160 | -                        | 10⅝"w x 6¼"h | Right | Black  | Manual | -    | -     |



Call the Velvac Sales Team: **800.783.8871** [sales@velvac.com](mailto:sales@velvac.com)

© VELVAC INC. • 2405 South Calhoun Road • New Berlin, WI 53151-2709 • Toll Free: 800.783.8871 • Fax: 262.786.4101





### Vehicle:

TranStar 8100, 8100CH, 8200, 8500, 8600 (2002-Present)

- Fits 1 1/8" tube

### Head Adjustable

- Convex head size: 7 1/4" w x 7 1/4" h x 3" d

### Glass Adjustable

- Convex head size: 8 7/16" w x 6 5/8" h x 4 1/2" d

### Accessories

#### • Head Clamp & Screw Kit

Model 405 | Part # V624059999  
(OEM 2507274C1)

### Fender Bracket Assembly *No head provided*

| Model | Left Bracket # | Right Bracket # | Color     | Material  | Heat |
|-------|----------------|-----------------|-----------|-----------|------|
| 404   | V584049101     | V584049102      | Stainless | Stainless | -    |
| 404   | V584049111     | V584049112      | Black     | Steel     | -    |

### Convex Glass Head *Head adjustable*

| Model | Part #     | O.E.M.    | Glass Size          | Side | Color  | M/R    | Heat | Light |
|-------|------------|-----------|---------------------|------|--------|--------|------|-------|
| 388   | V563882208 | 2507272C1 | 6 3/4" w x 6 3/4" h | Both | Chrome | Manual | -    | -     |
| 409   | V564090013 | -         | 6 3/4" w x 6 3/4" h | Both | Black  | Manual | -    | -     |

### Convex Glass Head *Glass adjustable*

| Model | Part #                  | Glass Size          | Side | Color  | M/R    | Heat | Light |
|-------|-------------------------|---------------------|------|--------|--------|------|-------|
| 428   | V564281013 <sup>1</sup> | 7 3/4" w x 5 3/4" h | Both | Chrome | Manual | -    | -     |
| 428   | V564281001              | 7 3/4" w x 5 3/4" h | Both | Black  | Manual | -    | -     |

### Convex Glass Kit

| Model | Part #                  | O.E.M.    | Glass Size          | Side | Color | M/R    | Heat |
|-------|-------------------------|-----------|---------------------|------|-------|--------|------|
| 388   | V153882120              | 2507273C1 | 6 3/4" w x 6 3/4" h | Both | Black | Manual | -    |
| 428   | V154280001              | -         | 7 3/4" w x 5 3/4" h | Both | Black | Manual | -    |
| 428   | V614280008 <sup>2</sup> | -         | 7 3/4" w x 5 3/4" h | Both | Black | Manual | -    |

### Convex Mirror Cover

| Model | Part #     | Side | Color  | Light |
|-------|------------|------|--------|-------|
| 428   | V134281015 | Both | Chrome | -     |
| 428   | V134281011 | Both | Black  | -     |

### NOTES

**M/R** Manual / remote

\*Vertical bracket on Bracket Assembly is 1 15/16" longer (taller) than OEM standard bracket, in order to accommodate either Head Adjustable or Glass Adjustable mirror options

<sup>1</sup> Chrome backcover with chrome housing

<sup>2</sup> Includes housing

# MIRRORS

## INTERNATIONAL

### 404 System | WorkStar



#### Vehicle:

WorkStar 7300, 7400, 7500, 7600, 7700, Hybrid (2002-Present)

- Fits 1 1/8" tube

#### Head Adjustable

- Convex head size: 7 1/4" w x 7 1/4" h x 3" d

#### Glass Adjustable

- Convex head size: 8 7/16" w x 6 5/8" h x 4 1/2" d

#### Accessories

- **Head Clamp & Screw Kit**

Model 405 | Part # V624059999 (OEM 2507274C1)

#### Fender Bracket Assembly No head provided

| Model | Left Bracket # | Right Bracket # | Color     | Material  | Heat |
|-------|----------------|-----------------|-----------|-----------|------|
| 404   | V584049301     | V584049302      | Stainless | Stainless | -    |
| 404   | V584049311     | V584049312      | Black     | Steel     | -    |

#### Convex Glass Head Head adjustable

| Model | Part #     | O.E.M.    | Glass Size          | Side | Color  | M/R    | Heat | Light |
|-------|------------|-----------|---------------------|------|--------|--------|------|-------|
| 388   | V563882208 | 2507272C1 | 6 3/4" w x 6 3/4" h | Both | Chrome | Manual | -    | -     |
| 409   | V564090013 | -         | 6 3/4" w x 6 3/4" h | Both | Black  | Manual | -    | -     |

#### Convex Glass Head Glass adjustable

| Model | Part #                  | Glass Size          | Side | Color  | M/R    | Heat | Light |
|-------|-------------------------|---------------------|------|--------|--------|------|-------|
| 428   | V564281013 <sup>1</sup> | 7 3/4" w x 5 3/4" h | Both | Chrome | Manual | -    | -     |
| 428   | V564281001              | 7 3/4" w x 5 3/4" h | Both | Black  | Manual | -    | -     |

#### Convex Glass Kit

| Model | Part #                  | O.E.M.    | Glass Size          | Side | Color | M/R    | Heat |
|-------|-------------------------|-----------|---------------------|------|-------|--------|------|
| 388   | V153882120              | 2507273C1 | 6 3/4" w x 6 3/4" h | Both | Black | Manual | -    |
| 428   | V154280001              | -         | 7 3/4" w x 5 3/4" h | Both | Black | Manual | -    |
| 428   | V614280008 <sup>2</sup> | -         | 7 3/4" w x 5 3/4" h | Both | Black | Manual | -    |

#### Convex Mirror Cover

| Model | Part #     | Side | Color  | Light |
|-------|------------|------|--------|-------|
| 428   | V134281015 | Both | Chrome | -     |
| 428   | V134281011 | Both | Black  | -     |

#### NOTES

**M/R** Manual / remote

\*Vertical bracket on Bracket Assembly is 2 1/16" longer (taller) than OEM standard bracket, in order to accommodate either Head Adjustable or Glass Adjustable mirror options

<sup>1</sup> Chrome backcover with chrome housing

<sup>2</sup> Includes housing



Call the Velvac Sales Team: **800.783.8871** sales@velvac.com

© VELVAC INC. • 2405 South Calhoun Road • New Berlin, WI 53151-2709 • Toll Free: 800.783.8871 • Fax: 262.786.4101

## INTERNATIONAL

Various | **Look Down Mirrors**



Convex Look Down Mirror

Convex Glass Kit

**Vehicle:**

Various (2001-2005)

**Bracket Mount**

**Convex Head Size**

11<sup>3</sup>/<sub>16</sub>"w x 6<sup>7</sup>/<sub>8</sub>"h x 2<sup>7</sup>/<sub>16</sub>"d

**Bracket Hole Location**

**Width Between Holes:**

3<sup>1</sup>/<sub>16</sub>"

**Hole Size:**

1<sup>1</sup>/<sub>64</sub>"

**NOTES**

**M/R** Manual / remote

<sup>1</sup> Furnished with black arm, chrome back cover, black bezel and black holder

<sup>2</sup> Furnished with black arm, black back cover, black bezel and black holder

<sup>3</sup> Includes bezel kit

### Convex Look Down Mirror

| Model | Part #                  | O.E.M.    | Glass Size                                                           | Side  | Color  | M/R    | Heat | Light |
|-------|-------------------------|-----------|----------------------------------------------------------------------|-------|--------|--------|------|-------|
| 360   | V593605228 <sup>1</sup> | 3571502C2 | 10 <sup>5</sup> / <sub>8</sub> "w x 6 <sup>1</sup> / <sub>4</sub> "h | Right | Chrome | Manual | -    | -     |
| 360   | V593601152 <sup>2</sup> | 3571501C1 | 10 <sup>5</sup> / <sub>8</sub> "w x 6 <sup>1</sup> / <sub>4</sub> "h | Right | Black  | Manual | -    | -     |

### Convex Glass Kit

| Model | Part #                  | O.E.M.                 | Glass Size                                                           | Side | Color | M/R    | Heat |
|-------|-------------------------|------------------------|----------------------------------------------------------------------|------|-------|--------|------|
| 360   | V613600001 <sup>3</sup> | 2585911C1<br>2585911C2 | 10 <sup>5</sup> / <sub>8</sub> "w x 6 <sup>1</sup> / <sub>4</sub> "h | Both | Black | Manual | -    |

## KENWORTH

T680, T880 | **481 System**

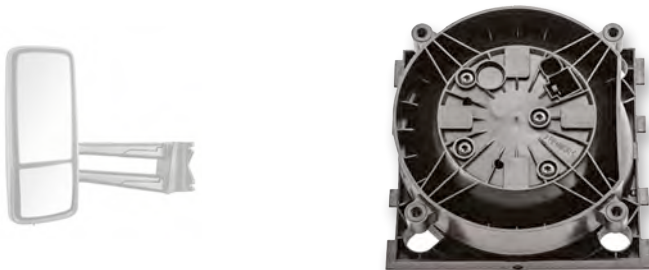

Actuator

**Vehicle:**

T680, T880 (2012-Present)

**Pedestal Mount**

**Head Size**

9"w x 21<sup>3</sup>/<sub>8</sub>"h

**NOTES**

Bracket, head and glass not available. Contact OE to purchase.

### Flat Mirror Actuator

| Model | Part #     | O.E.M.   | Side |
|-------|------------|----------|------|
| 480   | V084803997 | 84803997 | Both |

# MIRRORS

## KOVATCH MOBILE EQUIPMENT (KME)

**407 System** | Eliminator, Dryside Tanker. Heavy Duty Rescue. Challenger, Legacy, Rearmount Pumper. TDA, Midmount, Rearmount Ladder/Platform. Predator, Severe Service, Panther and Legacy



Side Mount Bracket



Flat Glass Kit



Convex Glass Kit

### Vehicle:

Eliminator, Dryside Tanker. Heavy Duty Rescue. Challenger, Legacy, Rearmount Pumper. TDA, Midmount, Rearmount Ladder/Platform. Predator, Severe Service, Panther and Legacy (2003-Present)

- Fits 1- 1 1/8" tube

### Flat Head Size

7 5/16" w x 16 3/8" h x 4 5/8" d

### Convex Head Size

7 1/4" w x 7 1/4" h x 5 1/8" d

### NOTES

**M/R** Manual / remote

<sup>1</sup> Furnished less electrical harness. Contact Velvac for specific part numbers and availability

- For Airport RIV, Commercial Chassis, Wetside, Elliptical, Wildland Interface, Ridgerunner, Specialty, and Medium Duty Rescue, consult specific vehicle make/model section of this catalog.

### Side Mount Bracket

| Model | Part #                  | Dimension "A" | Dimension "B" | Side | Color     | Material  |
|-------|-------------------------|---------------|---------------|------|-----------|-----------|
| 407   | V584070300 <sup>1</sup> | 28 3/16"      | 7 6/34"       | Both | Stainless | Stainless |

- Dimension A: Distance between upper and lower bracket holder mounting holes
- Dimension B: Distance between the outside edge of the mirror bracket and the mounting surface

### Flat Glass Housing Head adjustable. Order glass to make complete head

| Model | Part #     | Glass Size           | Side  | Color  | M/R    | Heat | Light |
|-------|------------|----------------------|-------|--------|--------|------|-------|
| 409   | V514090029 | 6 3/4" w x 15 7/8" h | Right | Chrome | Remote | •    | -     |
| 409   | V514090028 | 6 3/4" w x 15 7/8" h | Left  | Chrome | Remote | •    | -     |

### Flat Glass Kit

| Model | Part #     | O.E.M.     | Glass Size           | Side | Color | M/R  | Heat |
|-------|------------|------------|----------------------|------|-------|------|------|
| 383   | V153832107 | 054627V007 | 6 3/4" w x 15 7/8" h | Both | Black | Both | •    |



Call the Velvac Sales Team: **800.783.8871** [sales@velvac.com](mailto:sales@velvac.com)

© VELVAC INC. • 2405 South Calhoun Road • New Berlin, WI 53151-2709 • Toll Free: 800.783.8871 • Fax: 262.786.4101

## KOVATCH MOBILE EQUIPMENT (KME)

**407 System**  
Continued

### Convex Glass Head *Head adjustable*

| Model | Part #     | O.E.M.     | Glass Size  | Side | Color  | M/R    | Heat | Light |
|-------|------------|------------|-------------|------|--------|--------|------|-------|
| 409   | V564090025 | K564090025 | 6¾"w x 6¾"h | Both | Chrome | Manual | •    | -     |

### Convex Glass Kit

| Model | Part #     | O.E.M.     | Glass Size  | Side | Color | M/R    | Heat |
|-------|------------|------------|-------------|------|-------|--------|------|
| 388   | V153882117 | 054627V004 | 6¾"w x 6¾"h | Both | Black | Manual | •    |

### Flat Mirror Actuators

| Model | Part #     | Side  |
|-------|------------|-------|
| 409   | V084090002 | Right |
| 409   | V084090001 | Left  |

### Accessories

- **Mirror Head Clamp**  
Model 387 | Part # V113870510B  
(OEM 005881V177)
- **Head Clamp & Screws Kit**  
Model 405 | Part # V624059999
- **Wire Harness Kit**  
Model 387 | Part # V613871998
- **2-Mirror Switch**  
Part # V083200233  
(OEM 005881V178)

# MIRRORS

## KOVATCH MOBILE EQUIPMENT (KME)

**407 System** | Eliminator, Dryside Tanker. Heavy Duty Rescue. Challenger, Legacy, Rearmount Pumper. TDA, Midmount, Rearmount Ladder/Platform. Predator, Severe Service, Panther and Legacy



Side Mount Bracket

Flat Glass Head

Convex Glass Head

### Vehicle:

Eliminator, Dryside Tanker. Heavy Duty Rescue. Challenger, Legacy, Rearmount Pumper. TDA, Midmount, Rearmount Ladder/Platform. Predator, Severe Service, Panther and Legacy (2003-Present)

- Fits 1- 1 1/8" tube

### Head Size

8 1/16" w x 15 1/16" h x 5 1/4" d

### NOTES

**M/R** Manual / remote

<sup>1</sup> Furnished less electrical harness. Contact Velvac for specific part numbers and availability

<sup>2</sup> Chrome backcover with chrome housing

- For Airport RIV, Commercial Chassis, Wetside, Elliptical, Wildland Interface, Ridgerunner, Specialty, and Medium Duty Rescue, consult specific vehicle make/model section of this catalog.

### Side Mount Bracket

| Model | Part #                  | Dimension "A" | Dimension "B" | Side | Color     | Material  |
|-------|-------------------------|---------------|---------------|------|-----------|-----------|
| 407   | V584070300 <sup>1</sup> | 28 13/16"     | 7 63/64"      | Both | Stainless | Stainless |

- Dimension A: Distance between upper and lower bracket holder mounting holes
- Dimension B: Distance between the outside edge of the mirror bracket and the mounting surface

### Flat Glass Head *Glass adjustable*

| Model | Part #                  | Glass Size           | Side  | Color  | M/R    | Heat | Light |
|-------|-------------------------|----------------------|-------|--------|--------|------|-------|
| 427   | V514270018 <sup>2</sup> | 7 1/4" w x 14 1/4" h | Right | Chrome | Remote | •    | •     |
| 427   | V514270017 <sup>2</sup> | 7 1/4" w x 14 1/4" h | Left  | Chrome | Remote | •    | •     |
| 427   | V514270016 <sup>2</sup> | 7 1/4" w x 14 1/4" h | Right | Chrome | Remote | •    | -     |
| 427   | V514270015 <sup>2</sup> | 7 1/4" w x 14 1/4" h | Left  | Chrome | Remote | •    | -     |

### Flat Glass Kit

| Model | Part #     | O.E.M.                   | Glass Size           | Side | Color | M/R  | Heat |
|-------|------------|--------------------------|----------------------|------|-------|------|------|
| 427   | V154270011 | 005881V191<br>005881V231 | 7 1/4" w x 14 1/4" h | Both | Black | Both | •    |



Call the Velvac Sales Team: **800.783.8871** sales@velvac.com

© VELVAC INC. • 2405 South Calhoun Road • New Berlin, WI 53151-2709 • Toll Free: 800.783.8871 • Fax: 262.786.4101

## KOVATCH MOBILE EQUIPMENT (KME)

**407 System**  
Continued

### Mirror Cover

| Model | Part #                    | Side | Color  | Light |
|-------|---------------------------|------|--------|-------|
| 427   | V134271008                | Both | Chrome | -     |
| 427   | V134271009 <sup>3</sup>   | Both | Chrome | •     |
| 427   | V614271007 <sup>3,4</sup> | Both | Chrome | •     |

### Accessories

- **Marker Light Kit w/ Bezel**  
Model 427 | Part # V114272001
- **Head Clamp & Screws Kit**  
Model 400 | Part # V614000010
- **2-Mirror Switch**  
Part # V083200233  
(OEM 005881V178)

### Convex Glass Head *Glass adjustable*

| Model | Part #                    | Glass Size  | Side | Color  | M/R    | Heat | Light |
|-------|---------------------------|-------------|------|--------|--------|------|-------|
| 428   | V564281014 <sup>2</sup>   | 7¾"w x 5¾"h | Both | Chrome | Manual | •    | -     |
| 428   | V564281015 <sup>2,5</sup> | 7¾"w x 5¾"h | Both | Chrome | Manual | •    | -     |

### Convex Glass Kit

| Model | Part #                  | O.E.M.     | Glass Size  | Side | Color | M/R    | Heat |
|-------|-------------------------|------------|-------------|------|-------|--------|------|
| 428   | V154280002              | -          | 7¾"w x 5¾"h | Both | Black | Manual | •    |
| 428   | V154280003 <sup>5</sup> | 005881V167 | 7¾"w x 5¾"h | Both | Black | Manual | •    |

### Convex Mirror Cover

| Model | Part #     | Side | Color  | Light |
|-------|------------|------|--------|-------|
| 428   | V134281015 | Both | Chrome | -     |

### Flat Mirror Actuator

| Model | Part #     | Side |
|-------|------------|------|
| 427   | V084270006 | Both |

### NOTES

- <sup>2</sup> Chrome backcover with chrome housing  
<sup>3</sup> Furnished with punched holes  
<sup>4</sup> Kit furnished with marker light  
<sup>5</sup> Furnished with turn signal

## PETERBILT

480 System | 567, 579



Actuator

### Vehicle:

567, 579 (2012-Present)

### Pedestal Mount Head Size

9<sup>3</sup>/<sub>8</sub>"w x 22<sup>5</sup>/<sub>8</sub>"h

### NOTES

Bracket, head and glass not available.  
Contact OE to purchase.

### Flat Mirror Actuator

| Model | Part #     | O.E.M.   | Side |
|-------|------------|----------|------|
| 480   | V084803997 | 84803997 | Both |



Call the Velvac Sales Team: **800.783.8871** [sales@velvac.com](mailto:sales@velvac.com)

© VELVAC INC. • 2405 South Calhoun Road • New Berlin, WI 53151-2709 • Toll Free: 800.783.8871 • Fax: 262.786.4101



## PIERCE MANUFACTURING

PUC Ariels, Pumpers, Rescues. Arrow XT™, Impel™, Quantum®, Saber®, Velocity®  
| **407 System**

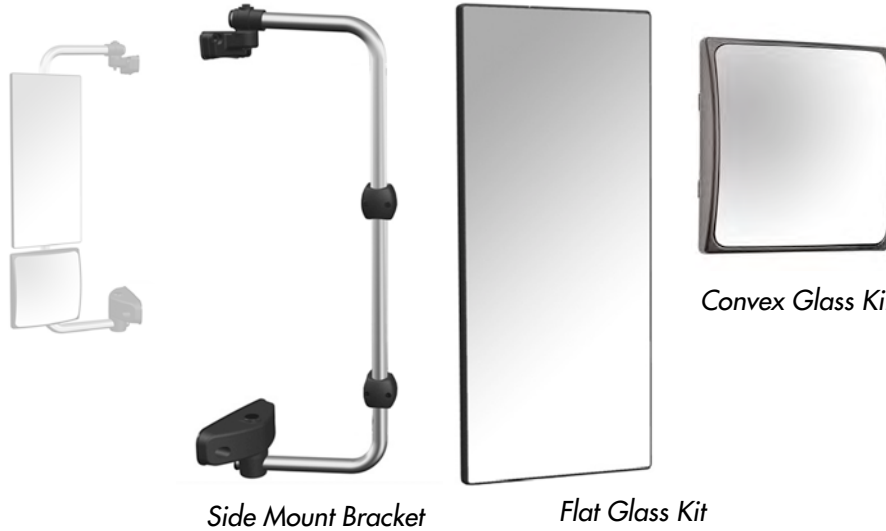

### Vehicle:

PUC Ariels, Pumpers, Rescues.  
Arrow XT™, Impel™, Quantum®,  
Saber®, Velocity® (2003-Present)

- Fits 1- 1 1/8" tube

### Flat Head Size

7 5/16" w x 16 3/8" h x 4 5/8" d

### Convex Head Size

7 1/4" w x 7 1/4" h x 5 1/8" d

### NOTES

**M/R** Manual / remote

<sup>1</sup> Furnished less electrical harness. Contact Velvac for specific part numbers and availability

- For Commercial Pumpers, Tankers and Rescues, consult specific vehicle make/model section of this catalog

### Side Mount Bracket

| Model | Part #                  | Dimension "A" | Dimension "B"                     | Side | Color     | Material  |
|-------|-------------------------|---------------|-----------------------------------|------|-----------|-----------|
| 407   | V584070100 <sup>1</sup> | 26 1/2"       | 9 <sup>27</sup> / <sub>32</sub> " | Both | Stainless | Stainless |

- Dimension A: Distance between upper and lower bracket holder mounting holes
- Dimension B: Distance between the outside edge of the mirror bracket and the mounting surface

### Flat Glass Housing Head adjustable. Order glass to make complete head

| Model | Part #     | O.E.M.  | Glass Size           | Side  | Color  | M/R    | Heat | Light |
|-------|------------|---------|----------------------|-------|--------|--------|------|-------|
| 409   | V514090029 | 1443302 | 6 3/4" w x 15 7/8" h | Right | Chrome | Remote | •    | -     |
| 409   | V514090028 | 1964877 | 6 3/4" w x 15 7/8" h | Left  | Chrome | Remote | •    | -     |

### Flat Glass Kit

| Model | Part #     | O.E.M.      | Glass Size           | Side | Color | M/R  | Heat |
|-------|------------|-------------|----------------------|------|-------|------|------|
| 383   | V153832107 | A2254882002 | 6 3/4" w x 15 7/8" h | Both | Black | Both | •    |

## PIERCE MANUFACTURING

### 407 System

Continued

#### Convex Glass Head Head adjustable

| Model | Part #     | Glass Size  | Side | Color  | M/R    | Heat | Light |
|-------|------------|-------------|------|--------|--------|------|-------|
| 409   | V564090025 | 6¾"w x 6¾"h | Both | Chrome | Manual | •    | •     |

#### Convex Glass Kit

| Model | Part #     | O.E.M.  | Glass Size  | Side | Color | M/R    | Heat |
|-------|------------|---------|-------------|------|-------|--------|------|
| 388   | V153882117 | 2122881 | 6¾"w x 6¾"h | Both | Black | Manual | •    |

#### Flat Mirror Actuators

| Model | Part #     | Side  |
|-------|------------|-------|
| 409   | V084090002 | Right |
| 409   | V084090001 | Left  |

#### Accessories

- **Mirror Head Clamp**  
Model 387 | Part # V113870510B
- **Head Clamp & Screws Kit**  
Model 405 | Part # V624059999
- **Wire Harness Kit**  
Model 387 | Part # V613871998
- **2-Mirror Switch**  
Part # V084022051



Call the Velvac Sales Team: **800.783.8871** [sales@velvac.com](mailto:sales@velvac.com)

## PIERCE MANUFACTURING

PUC Ariels, Pumpers, Rescues. Arrow XT™, Impel™, Quantum®, Saber®, Velocity®  
| **407 System**



### Vehicle:

PUC Ariels, Pumpers, Rescues.  
Arrow XT™, Impel™, Quantum®,  
Saber®, Velocity® (2003-Present)

- Fits 1- 1 1/8" tube

### Head Size

8 1/16" w x 15 1/16" h x 5 1/4" d

### NOTES

**M/R** Manual / remote

<sup>1</sup> Furnished less electrical harness. Contact Velvac for specific part numbers and availability

<sup>2</sup> Chrome backcover with chrome housing

- For Commercial Pumpers, Tankers and Rescues, consult specific vehicle make/model section of this catalog

### Side Mount Bracket

| Model | Part #                  | Dimension "A" | Dimension "B" | Side | Color     | Material  |
|-------|-------------------------|---------------|---------------|------|-----------|-----------|
| 407   | V584070100 <sup>1</sup> | 26 1/2"       | 9 27/32"      | Both | Stainless | Stainless |

- Dimension A: Distance between upper and lower bracket holder mounting holes
- Dimension B: Distance between the outside edge of the mirror bracket and the mounting surface

### Flat Glass Head *Glass adjustable*

| Model | Part #                  | Glass Size           | Side  | Color  | M/R    | Heat | Light |
|-------|-------------------------|----------------------|-------|--------|--------|------|-------|
| 427   | V514270018 <sup>2</sup> | 7 1/4" w x 14 1/4" h | Right | Chrome | Remote | •    | •     |
| 427   | V514270017 <sup>2</sup> | 7 1/4" w x 14 1/4" h | Left  | Chrome | Remote | •    | •     |
| 427   | V514270016 <sup>2</sup> | 7 1/4" w x 14 1/4" h | Right | Chrome | Remote | •    | -     |
| 427   | V514270015 <sup>2</sup> | 7 1/4" w x 14 1/4" h | Left  | Chrome | Remote | •    | -     |

### Flat Glass Kit

| Model | Part #     | Glass Size           | Side | Color | M/R  | Heat |
|-------|------------|----------------------|------|-------|------|------|
| 427   | V154270011 | 7 1/4" w x 14 1/4" h | Both | Black | Both | •    |

## PIERCE MANUFACTURING

### 407 System

Continued

#### Mirror Cover

| Model | Part #                    | Side | Color  | Light |
|-------|---------------------------|------|--------|-------|
| 427   | V134271008                | Both | Chrome | -     |
| 427   | V134271009 <sup>3</sup>   | Both | Chrome | •     |
| 427   | V614271007 <sup>3,4</sup> | Both | Chrome | •     |

#### Convex Glass Head *Glass adjustable*

| Model | Part #                  | Glass Size    | Side | Color  | M/R    | Heat | Light |
|-------|-------------------------|---------------|------|--------|--------|------|-------|
| 428   | V564281014 <sup>2</sup> | 7¾" w x 5¾" h | Both | Chrome | Manual | •    | -     |

#### Convex Glass Kit

| Model | Part #     | Glass Size    | Side | Color | M/R    | Heat |
|-------|------------|---------------|------|-------|--------|------|
| 428   | V154280002 | 7¾" w x 5¾" h | Both | Black | Manual | •    |

#### Convex Mirror Cover

| Model | Part #     | Side | Color  | Light |
|-------|------------|------|--------|-------|
| 428   | V134281015 | Both | Chrome | -     |

#### Flat Mirror Actuator

| Model | Part #     | Side |
|-------|------------|------|
| 427   | V084270006 | Both |

#### Accessories

- **Marker Light Kit w/ Bezel**  
Model 427 | Part # V114272001
- **Head Clamp & Screws Kit**  
Model 400 | Part # V614000010
- **2-Mirror Switch**  
Part # V084022051  
(OEM 634860)

#### NOTES

- <sup>2</sup> Chrome backcover with chrome housing  
<sup>3</sup> Furnished with punched holes  
<sup>4</sup> Kit furnished with marker light



Call the Velvac Sales Team: **800.783.8871** [sales@velvac.com](mailto:sales@velvac.com)

© VELVAC INC. • 2405 South Calhoun Road • New Berlin, WI 53151-2709 • Toll Free: 800.783.8871 • Fax: 262.786.4101

Marauder II, Attacker HD | **407 System**

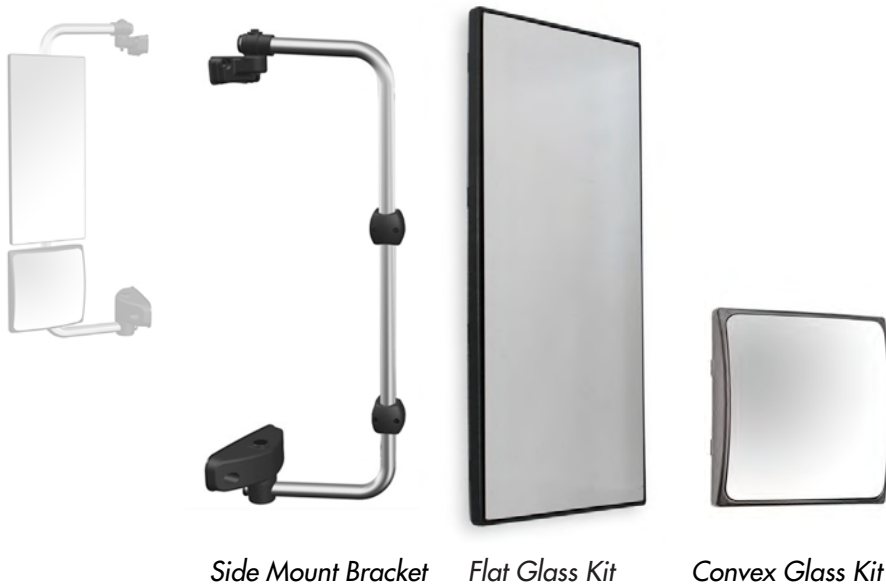

### Vehicle:

Marauder II, Attacker HD  
(2004-Present)

- Fits 1-1/8" tube

### Flat Head Size

7<sup>5</sup>/<sub>16</sub>"w x 16<sup>3</sup>/<sub>8</sub>"h x 4<sup>5</sup>/<sub>8</sub>"d

### Convex Head Size

7<sup>1</sup>/<sub>4</sub>"w x 7<sup>1</sup>/<sub>4</sub>"h x 5<sup>1</sup>/<sub>8</sub>"d

### NOTES

<sup>1</sup> Furnished less electrical harness. Contact Velvac for specific part numbers and availability

**M/R** Manual / remote

- For Commercial Optimum Series, consult specific vehicle make/model section of this catalog.

### Side Mount Bracket

| Model | Part #                  | O.E.M.     | Dimension "A"                     | Dimension "B"                     | Side | Color     | Material  |
|-------|-------------------------|------------|-----------------------------------|-----------------------------------|------|-----------|-----------|
| 407   | V584070100 <sup>1</sup> | S584070100 | 26 <sup>1</sup> / <sub>2</sub> "  | 9 <sup>27</sup> / <sub>32</sub> " | Both | Stainless | Stainless |
| 407   | V584070310 <sup>1</sup> | P3207000   | 31 <sup>3</sup> / <sub>4</sub> "  | 7 <sup>57</sup> / <sub>64</sub> " | Both | Stainless | Stainless |
| 407   | V584070320 <sup>1</sup> | S584070320 | 32 <sup>2</sup> / <sub>32</sub> " | 8 <sup>7</sup> / <sub>16</sub> "  | Both | Stainless | Stainless |

- Dimension A: Distance between upper and lower bracket holder mounting holes
- Dimension B: Distance between the outside edge of the mirror bracket and the mounting surface

### Flat Glass Housing Head adjustable. Order glass to make complete head

| Model | Part #     | O.E.M.   | Glass Size                                                           | Side  | Color  | M/R    | Heat | Light |
|-------|------------|----------|----------------------------------------------------------------------|-------|--------|--------|------|-------|
| 409   | V514090029 | P3206800 | 6 <sup>3</sup> / <sub>4</sub> "w x 15 <sup>7</sup> / <sub>8</sub> "h | Right | Chrome | Remote | •    | -     |
| 409   | V514090028 | P3206700 | 6 <sup>3</sup> / <sub>4</sub> "w x 15 <sup>7</sup> / <sub>8</sub> "h | Left  | Chrome | Remote | •    | -     |

### Flat Glass Kit

| Model | Part #     | O.E.M.               | Glass Size                                                           | Side | Color | M/R  | Heat |
|-------|------------|----------------------|----------------------------------------------------------------------|------|-------|------|------|
| 383   | V153832107 | P1680051<br>P2178761 | 6 <sup>3</sup> / <sub>4</sub> "w x 15 <sup>7</sup> / <sub>8</sub> "h | Both | Black | Both | •    |

## SEAGRAVE

### 407 System

Continued

#### Convex Glass Head Head adjustable

| Model | Part #     | O.E.M.   | Glass Size  | Side | Color  | M/R    | Heat | Light |
|-------|------------|----------|-------------|------|--------|--------|------|-------|
| 409   | V564090025 | P3207100 | 6¾"w x 6¾"h | Both | Chrome | Manual | •    | -     |

#### Convex Glass Kit

| Model | Part #     | O.E.M.                 | Glass Size  | Side | Color | M/R    | Heat |
|-------|------------|------------------------|-------------|------|-------|--------|------|
| 388   | V153882117 | P1680052<br>S153882117 | 6¾"w x 6¾"h | Both | Black | Manual | •    |

#### Flat Mirror Actuator

| Model | Part #     | O.E.M.   | Side  |
|-------|------------|----------|-------|
| 409   | V084090002 | P2316501 | Right |
| 409   | V084090001 | -        | Left  |

#### Accessories

- **Mirror Head Clamp**  
Model 387 | Part # V113870510B  
(OEM P3206600)
- **Head Clamp & Screws Kit**  
Model 405 | Part # V624059999
- **Wire Harness Kit**  
Model 387 | Part # V613871998
- **2-Mirror Switch**  
Part # V083200233  
(OEM P2005000)



Call the Velvac Sales Team: **800.783.8871** [sales@velvac.com](mailto:sales@velvac.com)

© VELVAC INC. • 2405 South Calhoun Road • New Berlin, WI 53151-2709 • Toll Free: 800.783.8871 • Fax: 262.786.4101

Marauder II, Attacker HD | **407 System**



Flat Glass Head



Convex Glass Head

### Vehicle:

Marauder II, Attacker HD  
(2004-Present)

- Fits 1-1/8" tube

### Head Size

8 1/16" w x 15 1/16" h x 5/4" d

### NOTES

**M/R** Manual / remote

<sup>1</sup> Furnished with wiring harness for flat remote, flat/convex heat, marker light and turn signal

<sup>2</sup> Furnished less electrical harness. Contact Velvac for specific part numbers and availability

<sup>3</sup> Chrome backcover with chrome housing

<sup>4</sup> For use with bracket assembly V584070502

<sup>5</sup> For use with bracket assembly V584070310

- For Commercial Optimum Series, consult specific vehicle make/model section of this catalog.

### Side Mount Bracket

| Model | Part #                  | O.E.M.   | Dimension "A" | Dimension "B" | Side | Color     | Material  |
|-------|-------------------------|----------|---------------|---------------|------|-----------|-----------|
| 407   | V584070500 <sup>1</sup> | -        | 3 1/4"        | 8 7/16"       | Both | Stainless | Stainless |
| 407   | V584070310 <sup>2</sup> | P3207000 | 3 1/4"        | 7 5/16"       | Both | Stainless | Stainless |

- Dimension A: Distance between upper and lower bracket holder mounting holes
- Dimension B: Distance between the outside edge of the mirror bracket and the mounting surface

### Flat Glass Head Glass adjustable

| Model | Part #                     | Glass Size           | Side  | Color  | M/R    | Heat | Light |
|-------|----------------------------|----------------------|-------|--------|--------|------|-------|
| 427   | V514270018 <sup>3, 4</sup> | 7 1/4" w x 14 1/4" h | Right | Chrome | Remote | •    | •     |
| 427   | V514270017 <sup>3, 4</sup> | 7 1/4" w x 14 1/4" h | Left  | Chrome | Remote | •    | •     |
| 427   | V514270016 <sup>3, 5</sup> | 7 1/4" w x 14 1/4" h | Right | Chrome | Remote | •    | -     |
| 427   | V514270015 <sup>3, 5</sup> | 7 1/4" w x 14 1/4" h | Left  | Chrome | Remote | •    | -     |

### Flat Glass Kit

| Model | Part #     | Glass Size           | Side | Color | M/R  | Heat |
|-------|------------|----------------------|------|-------|------|------|
| 427   | V154270011 | 7 1/4" w x 14 1/4" h | Both | Black | Both | •    |

## SEAGRAVE

### 407 System

Continued

#### Mirror Cover

| Model | Part #                    | Side | Color  | Light |
|-------|---------------------------|------|--------|-------|
| 427   | V134271009 <sup>6</sup>   | Both | Chrome | •     |
| 427   | V614271007 <sup>6,7</sup> | Both | Chrome | •     |
| 427   | V134271008                | Both | Chrome | -     |

#### Convex Glass Head *Glass adjustable*

| Model | Part #                    | Glass Size                                                          | Side | Color  | M/R    | Heat | Light |
|-------|---------------------------|---------------------------------------------------------------------|------|--------|--------|------|-------|
| 428   | V564281015 <sup>8,9</sup> | 7 <sup>3</sup> / <sub>4</sub> "w x 5 <sup>3</sup> / <sub>4</sub> "h | Both | Chrome | Manual | •    | -     |
| 428   | V564281014 <sup>3,5</sup> | 7 <sup>3</sup> / <sub>4</sub> "w x 5 <sup>3</sup> / <sub>4</sub> "h | Both | Chrome | Manual | •    | -     |

#### Convex Glass Kit

| Model | Part #                  | Glass Size                                                          | Side | Color | M/R    | Heat |
|-------|-------------------------|---------------------------------------------------------------------|------|-------|--------|------|
| 428   | V154280003 <sup>8</sup> | 7 <sup>3</sup> / <sub>4</sub> "w x 5 <sup>3</sup> / <sub>4</sub> "h | Both | Black | Manual | •    |
| 428   | V154280002              | 7 <sup>3</sup> / <sub>4</sub> "w x 5 <sup>3</sup> / <sub>4</sub> "h | Both | Black | Manual | •    |

#### Convex Mirror Cover

| Model | Part #     | Side | Color  | Light |
|-------|------------|------|--------|-------|
| 428   | V134281015 | Both | Chrome | -     |

#### Flat Mirror Actuator

| Model | Part #     | Side |
|-------|------------|------|
| 427   | V084270006 | Both |

#### Accessories

- **Marker Light Kit w/ Bezel**  
Model 427 | Part # V114272001
- **Head Clamp & Screws Kit**  
Model 400 | Part # V614000010
- **2-Mirror Switch**  
Part # V083200233  
(OEM 2005000)

#### NOTES

- <sup>3</sup> Chrome backcover with chrome housing
- <sup>5</sup> For use with bracket assembly V584070310
- <sup>6</sup> Furnished with punched holes
- <sup>7</sup> Kit furnished with marker light
- <sup>8</sup> Furnished with turn signal
- <sup>9</sup> For use with bracket assembly V584070502



Call the Velvac Sales Team: **800.783.8871** sales@velvac.com

© VELVAC INC. • 2405 South Calhoun Road • New Berlin, WI 53151-2709 • Toll Free: 800.783.8871 • Fax: 262.786.4101



## SPARTAN CHASSIS

Gladiator<sup>®</sup>, Metro Star<sup>®</sup>, Metro Star<sup>®</sup> -X, Metro Star<sup>®</sup> - RT | **407 System**



### Vehicle:

Gladiator<sup>®</sup>, Metro Star<sup>®</sup>, Metro Star<sup>®</sup> -X, Metro Star<sup>®</sup> - RT (2004-Present)

- Fits 1- 1 1/8" tube

### Head Size

8 1/16" w x 15 1/16" h x 5 1/4" d

### NOTES

**M/R** Manual / remote

<sup>1</sup> Furnished with wiring harness for flat remote, flat/convex heat, marker light and turn signal

<sup>2</sup> Furnished less electrical harness. Contact Velvac for specific part numbers and availability

<sup>3</sup> Chrome backcover with chrome housing

<sup>4</sup> For use with bracket assembly V584070502

<sup>5</sup> For use with bracket assembly V584070310

<sup>6</sup> For use with bracket assembly V584070312

### Side Mount Bracket

| Model | Part #                  | O.E.M.   | Dimension "A" | Dimension "B" | Side | Color     | Material  |
|-------|-------------------------|----------|---------------|---------------|------|-----------|-----------|
| 407   | V584070500 <sup>1</sup> | -        | 31 3/4"       | 8 7/16"       | Both | Stainless | Stainless |
| 407   | V584070310 <sup>2</sup> | P3207000 | 31 3/4"       | 7 57/64"      | Both | Stainless | Stainless |
| 407   | V584070312 <sup>2</sup> | -        | 31 3/4"       | 7 57/64"      | Both | Black     | Steel     |

- Dimension A: Distance between upper and lower bracket holder mounting holes
- Dimension B: Distance between the outside edge of the mirror bracket and the mounting surface

### Flat Glass Head Glass adjustable

| Model | Part #                    | Glass Size           | Side  | Color  | M/R    | Heat | Light |
|-------|---------------------------|----------------------|-------|--------|--------|------|-------|
| 427   | V514270018 <sup>3,4</sup> | 7 1/4" w x 14 1/4" h | Right | Chrome | Remote | •    | •     |
| 427   | V514270017 <sup>3,4</sup> | 7 1/4" w x 14 1/4" h | Left  | Chrome | Remote | •    | •     |
| 427   | V514270016 <sup>3,5</sup> | 7 1/4" w x 14 1/4" h | Right | Chrome | Remote | •    | -     |
| 427   | V514270015 <sup>3,5</sup> | 7 1/4" w x 14 1/4" h | Left  | Chrome | Remote | •    | -     |
| 427   | V514270122 <sup>6</sup>   | 7 1/4" w x 14 1/4" h | Right | Black  | Remote | •    | -     |
| 427   | V514270121 <sup>6</sup>   | 7 1/4" w x 14 1/4" h | Left  | Black  | Remote | •    | -     |

## SPARTAN CHASSIS

### 407 System

Continued

#### Flat Glass Kit

| Model | Part #                  | Glass Size   | Side  | Color | M/R  | Heat |
|-------|-------------------------|--------------|-------|-------|------|------|
| 427   | V154270011              | 7¼"w x 14¼"h | Both  | Black | Both | •    |
| 427   | V614270004 <sup>7</sup> | 7¼"w x 14¼"h | Right | Black | Both | •    |
| 427   | V614270005 <sup>7</sup> | 7¼"w x 14¼"h | Left  | Black | Both | •    |

#### Mirror Cover

| Model | Part #                      | Side | Color  | Light |
|-------|-----------------------------|------|--------|-------|
| 427   | V134271009 <sup>10</sup>    | Both | Chrome | •     |
| 427   | V614271007 <sup>8, 10</sup> | Both | Chrome | •     |
| 427   | V134271008                  | Both | Chrome | -     |
| 427   | V134271000                  | Both | Black  | -     |

#### Accessories

- **Marker Light Kit w/ Bezel**  
Model 427 | Part # V114272001
- **Head Clamp & Screws Kit**  
Model 400 | Part # V614000010
- **2-Mirror Switch**  
Part # V083200233  
(OEM 0497RR8001)

#### Convex Glass Head *Glass adjustable*

| Model | Part #                     | Glass Size  | Side | Color  | M/R    | Heat | Light |
|-------|----------------------------|-------------|------|--------|--------|------|-------|
| 428   | V564281015 <sup>4, 9</sup> | 7¾"w x 5¾"h | Both | Chrome | Manual | •    | -     |
| 428   | V564281014 <sup>3, 5</sup> | 7¾"w x 5¾"h | Both | Chrome | Manual | •    | -     |
| 428   | V564281002 <sup>6</sup>    | 7¾"w x 5¾"h | Both | Black  | Manual | •    | -     |

#### Convex Glass Kit

| Model | Part #                  | Glass Size  | Side | Color | M/R    | Heat |
|-------|-------------------------|-------------|------|-------|--------|------|
| 428   | V154280003 <sup>9</sup> | 7¾"w x 5¾"h | Both | Black | Manual | •    |
| 428   | V154280002              | 7¾"w x 5¾"h | Both | Black | Manual | •    |

#### Convex Mirror Cover

| Model | Part #     | Side | Color  | Light |
|-------|------------|------|--------|-------|
| 428   | V134281015 | Both | Chrome | -     |
| 428   | V134281011 | Both | Black  | -     |

#### NOTES

- <sup>3</sup> Chrome backcover with chrome housing
- <sup>4</sup> For use with bracket assembly V584070502
- <sup>5</sup> For use with bracket assembly V584070310
- <sup>6</sup> For use with bracket assembly V584070312
- <sup>7</sup> Flat glass kit with housing
- <sup>8</sup> Kit furnished with marker light
- <sup>9</sup> Furnished with turn signal
- <sup>10</sup> Furnished with punched holes

#### Flat Mirror Actuator

| Model | Part #     | Side |
|-------|------------|------|
| 427   | V084270006 | Both |



Call the Velvac Sales Team: **800.783.8871** sales@velvac.com

© VELVAC INC. • 2405 South Calhoun Road • New Berlin, WI 53151-2709 • Toll Free: 800.783.8871 • Fax: 262.786.4101

### Sprinter Vans | Straight Van Chassis Applications



**Vehicle:**

Sprinter Vans

- Kits include mirror head, bracket and stainless steel mounting hardware
- Assemblies include an 8½" K-10 Eyeball convex mirror

| Kit #  | Color                                 |
|--------|---------------------------------------|
| 716902 | Stainless bracket w/<br>black 10" ABS |

### Sprinter Vans | Van and Cab Chassis Mirrors



**Vehicle:**

Sprinter Vans

- Powder coated loop and cast mounting ends fit directly into older OE mounting base (not included)
- Includes 6½" x 10" upper flat glass head and 6½" x 6" lower convex
- For use up to 86" wide body applications

| Part # | Description   | Color |
|--------|---------------|-------|
| 715704 | Complete pair | Black |

# MIRRORS

## SUTPHEN

**407 System** | Aerial Platforms, Aerial Ladders, Pumpers, Specialty, Wildland, Industrial



Side Mount Bracket

Flat Glass Head

### Vehicle:

Aerial Platforms - SP70, SP95, SPH100, Remount. Aerial Ladders - SA75, SA100. Pumpers - Guardian, Monarch, Shield. Specialty - Heavy Rescue. Wildland - Type I. Industrial - SA|110, SP|112, Pumper (2004-Present)

- Fits 1- 1 1/8" tube

### Head Size

8 1/6" w x 15 1/6" h x 5 1/4" d

### NOTES

**M/R** Manual / remote

<sup>1</sup> Furnished less electrical harness. Contact Velvac for specific part numbers and availability

<sup>2</sup> Chrome backcover with chrome housing

- For Commercial Pumpers and Elliptical or Wetside Tankers, consult the specific vehicle make/model section of this catalog

### Side Mount Bracket w/ Modified Lower Holder

| Model | Part #                  | Dimension "A" | Dimension "B" | Side | Color     | Material  |
|-------|-------------------------|---------------|---------------|------|-----------|-----------|
| 407   | V584071300 <sup>1</sup> | 28 1/6"       | 7 63/64"      | Both | Stainless | Stainless |

- Dimension A: Distance between upper and lower bracket holder mounting holes
- Dimension B: Distance between the outside edge of the mirror bracket and the mounting surface

### Flat Glass Head *Glass adjustable*

| Model | Part #                  | O.E.M.    | Glass Size           | Side  | Color  | M/R    | Heat | Light |
|-------|-------------------------|-----------|----------------------|-------|--------|--------|------|-------|
| 427   | V514270018 <sup>2</sup> | -         | 7 1/4" w x 14 1/4" h | Right | Chrome | Remote | •    | •     |
| 427   | V514270017 <sup>2</sup> | -         | 7 1/4" w x 14 1/4" h | Left  | Chrome | Remote | •    | •     |
| 427   | V514270016 <sup>2</sup> | HC21Q23QX | 7 1/4" w x 14 1/4" h | Right | Chrome | Remote | •    | -     |
| 427   | V514270015 <sup>2</sup> | -         | 7 1/4" w x 14 1/4" h | Left  | Chrome | Remote | •    | -     |
| 427   | V514270019 <sup>2</sup> | -         | 7 1/4" w x 14 1/4" h | Both  | Chrome | Manual | -    | -     |



Call the Velvac Sales Team: **800.783.8871** sales@velvac.com

© VELVAC INC. • 2405 South Calhoun Road • New Berlin, WI 53151-2709 • Toll Free: 800.783.8871 • Fax: 262.786.4101

#### Flat Glass Kit

| Model | Part #     | Glass Size   | Side | Color | M/R  | Heat |
|-------|------------|--------------|------|-------|------|------|
| 427   | V154270011 | 7¼"w x 14¼"h | Both | Black | Both | •    |
| 427   | V154270010 | 7¼"w x 14¼"h | Both | Black | Both | -    |

#### Mirror Cover

| Model | Part #                    | Side | Color  | Light |
|-------|---------------------------|------|--------|-------|
| 427   | V134271009 <sup>3</sup>   | Both | Chrome | •     |
| 427   | V134271008                | Both | Chrome | -     |
| 427   | V614271007 <sup>3,4</sup> | Both | Chrome | •     |

#### Accessories

- **Marker Light Kit w/ Bezel**  
Model 427 | Part # V114272001
- **Head Clamp & Screws Kit**  
Model 400 | Part # V614000010

#### Convex Glass Head *Glass adjustable*

| Model | Part #                    | Glass Size  | Side | Color  | M/R    | Heat | Light |
|-------|---------------------------|-------------|------|--------|--------|------|-------|
| 428   | V564281013 <sup>2</sup>   | 7¾"w x 5¾"h | Both | Chrome | Manual | -    | -     |
| 428   | V564281015 <sup>2,5</sup> | 7¾"w x 5¾"h | Both | Chrome | Manual | •    | -     |

#### Convex Glass Kit

| Model | Part #                  | Glass Size  | Side | Color | M/R    | Heat |
|-------|-------------------------|-------------|------|-------|--------|------|
| 428   | V154280001              | 7¾"w x 5¾"h | Both | Black | Manual | -    |
| 428   | V614280008 <sup>6</sup> | 7¾"w x 5¾"h | Both | Black | Manual | -    |
| 428   | V154280003 <sup>5</sup> | 7¾"w x 5¾"h | Both | Black | Manual | •    |

#### Convex Mirror Cover

| Model | Part #     | Side | Color  | Light |
|-------|------------|------|--------|-------|
| 428   | V134281015 | Both | Chrome | -     |

#### NOTES

- M/R** Manual / remote
- <sup>2</sup> Chrome backcover with chrome housing
- <sup>3</sup> Furnished with punched holes
- <sup>4</sup> Kit furnished with marker light
- <sup>5</sup> Furnished with turn signal
- <sup>6</sup> Includes housing

#### Flat Mirror Actuator

| Model | Part #     | Side |
|-------|------------|------|
| 427   | V084270006 | Both |

## USPS

### United States Post Office Mirrors



- All USPS mirrors are manufactured to USPS OE requirements and are USPS White



### Mirror and Bracket Kits

| Part # | Body Type     | Application      | Dimension   |
|--------|---------------|------------------|-------------|
| 712896 | LLV           | Right side       | 6½"w x 10"h |
| 712897 | LLV           | Left side        | 6½"w x 10"h |
| 712898 | LLV           | Front cross view | -           |
| 712900 | LLV           | Rear cross view  | -           |
| 714782 | CRV           | Right side       | 6½"w x 10"h |
| 714783 | CRV           | Left side        | 6½"w x 10"h |
| 714784 | CRV           | Front cross view | -           |
| 714785 | CRV           | Rear cross view  | -           |
| 714146 | Ford Aerostar | Rear cross view  | -           |
| 714147 | Ford Windstar | Rear cross view  | -           |
| 715786 | Dodge Caravan | Rear cross view  | -           |

### Replacement Main Head

| Part # | Body Type | Application       | Dimension   |
|--------|-----------|-------------------|-------------|
| 704122 | LLV       | Both side mirrors | 6½"w x 10"h |
| 704122 | CRV       | Both side mirrors | 6½"w x 10"h |

### Replacement Convex Head

| Part # | Body Type     | Application       | Dimension    |
|--------|---------------|-------------------|--------------|
| 704120 | LLV           | Both side mirrors | 6½"w x 6"h   |
| 723103 | LLV           | Front cross view  | 8" Diameter  |
| 709226 | LLV           | Rear cross view   | 10" Diameter |
| 704120 | CRV           | Both side mirrors | 6½"w x 6"h   |
| 723103 | CRV           | Front cross view  | 8" Diameter  |
| 709226 | CRV           | Rear cross view   | 10" Diameter |
| 708463 | Ford Aerostar | Rear cross view   | 8½" Diameter |
| 708463 | Ford Windstar | Rear cross view   | 8½" Diameter |
| 708463 | Dodge Caravan | Rear cross view   | 8½" Diameter |



Call the Velvac Sales Team: **800.783.8871** [sales@velvac.com](mailto:sales@velvac.com)

**VOLVO**

Various | **360 System**



**Vehicle:**

Various (2003-2005)

**Bracket Mount  
Convex Head Size**

11<sup>3</sup>/<sub>16</sub>"w x 6<sup>7</sup>/<sub>8</sub>"h x 2<sup>7</sup>/<sub>16</sub>"d

**Bracket Hole Location  
Width Between Holes:**

3<sup>15</sup>/<sub>16</sub>"

**Hole Size:**

1<sup>1</sup>/<sub>64</sub>"

**Look Down Mirror** *Furnished with black flip-out arm*

| Model | Part #     | O.E.M.  | Glass Size                                                        | Side  | Color | M/R    | Heat | Light |
|-------|------------|---------|-------------------------------------------------------------------|-------|-------|--------|------|-------|
| 360   | V593603121 | 3980815 | 10 <sup>9</sup> / <sub>8</sub> "x 6 <sup>6</sup> / <sub>8</sub> " | Right | Black | Manual | -    | -     |

**VOLVO**

VNL, VNM | **372 System**



*Actuator*

**Vehicle:**

VNL, VNM (1998-2005)

- Fits 20 mm tube

**Head Size**

9<sup>7</sup>/<sub>8</sub>"w x 26<sup>3</sup>/<sub>16</sub>"h x 4<sup>5</sup>/<sub>8</sub>"h

**Accessories**

- **Back Cover Plug Kit**  
Model 372 | Part # V613724110  
(OEM 3092008)
- **RAMI CB Insulator Kit**  
Model 387 | Part # V613871900

**Flat or Convex Mirror Actuator**

| Model | Part #     | O.E.M.    | Side |
|-------|------------|-----------|------|
| 372   | V613720112 | 613720112 | Both |

**NOTES**

Bracket, head and glass not available.  
Contact OE to purchase.

# MIRRORS

## VOLVO

### 412 System | Various



#### Vehicle:

Various (2005-Present)

#### Bracket Mount

#### Convex Head Size

11<sup>1</sup>/<sub>16</sub>"w x 6<sup>3</sup>/<sub>4</sub>"h x 2<sup>5</sup>/<sub>8</sub>"d

#### Bracket Hole Location

#### Width Between Holes:

3<sup>15</sup>/<sub>16</sub>" or 2<sup>3</sup>/<sub>4</sub>"

#### Hole Size:

1<sup>1</sup>/<sub>64</sub>"

**Look Down Mirror** *Furnished with fold-out arm*

| Model | Part #     | O.E.M.   | Glass Size                                                         | Side  | Color | M/R    | Heat | Light |
|-------|------------|----------|--------------------------------------------------------------------|-------|-------|--------|------|-------|
| 412   | V594121171 | 20701698 | 10 <sup>3</sup> / <sub>4</sub> " x 6 <sup>1</sup> / <sub>4</sub> " | Right | Black | Manual | -    | -     |

## VOLVO

### 472 System | VNM630, VNL 430, VNL 630, VNL 670, VNL 730, VNL 780, VNX 300, VNM200, VNM430



Actuator

#### Vehicle:

VNM200, VNM430, VNM630, VNL 430, VNL 630, VNL 670, VNL 730, VNL 780, VNX 300 (2008-September 2011)

- Fits 1<sup>1</sup>/<sub>4</sub>" tube

#### Head Size

9<sup>7</sup>/<sub>8</sub>"w x 25<sup>3</sup>/<sub>8</sub>"h x 6<sup>5</sup>/<sub>8</sub>"h

#### Accessories

#### • Standard CB Kit

Model 472 | Part # V614720004 (OEM 85108734)

#### • Premium CB Kit

Model 472 | Part # V614720005 (OEM 85108735)

#### • RAMI CB Insulator Kit

Model 387 | Part # V613871900

#### NOTES

Bracket, head and glass not available. Contact OE to purchase.

### Flat Mirror Actuator

| Model | Part #     | O.E.M.   | Side |
|-------|------------|----------|------|
| 472   | V614720001 | 85108732 | Both |



Call the Velvac Sales Team: **800.783.8871** sales@velvac.com

© VELVAC INC. • 2405 South Calhoun Road • New Berlin, WI 53151-2709 • Toll Free: 800.783.8871 • Fax: 262.786.4101



### 473 System |

VNM200, VNM430, VNM630, VNL 430, VNL 630, VNL 670, VNL 730, VNL 780, VNX 300

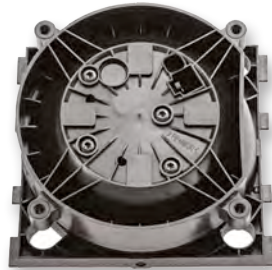

Actuator

#### Vehicle:

VNM200, VNM430, VNM630, VNL 430, VNL 630, VNL 670, VNL 730, VNL 780, VNX 300 (September 2011-Present)

- Fits 1 1/4" tube

#### Head Size

9 7/8" w x 25 3/8" h x 6 5/8" h

#### Accessories

- **Standard CB Kit**

Model 472 | Part # V614720004 (OEM 85108734)

- **Premium CB Kit**

Model 472 | Part # V614720005 (OEM 85108735)

- **RAMI CB Insulator Kit**

Model 387 | Part # V613871900

#### NOTES

Bracket, head and glass not available. Contact OE to purchase.

#### Flat Mirror Actuator

| Model | Part #     | O.E.M.   | Side |
|-------|------------|----------|------|
| 473   | V614730023 | 85133991 | Both |

## WESTERN STAR

### 4900EX, 4900SB | 401 System



Actuator

#### Vehicle:

4900EX, 4900SB (2002-Present)

- Fits 1 1/8" tube

#### Head Size

9 1/16" w x 23 5/8" h x 5 3/8" h

#### Accessories

- **Marker Light Assembly - Amber**

Model 401 | Part # V084010001 (OEM MEK084010001)

- **Marker Light Bezel**

Model 414 | Part # V084142400

- **RAMI CB Insulator Kit**

Model 387 | Part # V613871900 (OEM MEK613871900)

#### NOTES

Bracket, head and glass not available. Contact OE to purchase.

#### Flat Mirror Actuators

| Model | Part #     | Side  |
|-------|------------|-------|
| 384   | V083841400 | Right |
| 384   | V083841300 | Left  |

# MIRRORS

## 2020 MIRROR REPLACEMENT PARTS

### 2020 and 2020XG Mirror Replacement Parts



2020  
Standard  
head



2020  
Deluxe  
head



2020XG  
Mirror

| Mirror Heads                                |                  |           |                    |           | GM Topkick - Kodiak |           | Ford & GM Van |           |
|---------------------------------------------|------------------|-----------|--------------------|-----------|---------------------|-----------|---------------|-----------|
|                                             | 2020 Deluxe Head |           | 2020 Standard Head |           | 2020XG Mirror       |           |               |           |
|                                             | Right Side       | Left Side | Right Side         | Left Side | Right Side          | Left Side | Right Side    | Left Side |
| White manual                                | -                | -         | 714576             | 714576    | -                   | -         | 715988        | 715987    |
| White H/R flat, manual convex               | 714590           | 714589    | 714578             | 714578    | -                   | -         | 715992        | 715991    |
| White H/R w/ lower marker lamp              | -                | -         | -                  | -         | -                   | -         | 716506        | 716507    |
| Black manual                                | 714580           | 714579    | 714575             | 714575    | 715986              | 715985    | 715986        | 715985    |
| Black H/R flat, manual convex               | 714582           | 714581    | 714577             | 714577    | 716012              | 716011    | 715990        | 715989    |
| Black H/R flat, remote convex               | -                | -         | -                  | -         | -                   | -         | 719274        | 719275    |
| Black H/R flat, remote convex, signal arrow | -                | -         | -                  | -         | -                   | -         | 719276        | 719277    |
| Black H/R w/ lower marker lamp              | -                | -         | -                  | -         | -                   | -         | 716504        | 716505    |
| Black H/R w/ signal arrow                   | 716974           | 716973    | -                  | -         | -                   | -         | 716498        | 716499    |
| Chrome H/R flat                             | 714608           | 714607    | -                  | -         | -                   | -         | 715988        | 715997    |
| Chrome H/R w/ lower marker lamp             | -                | -         | -                  | -         | -                   | -         | 716508        | 716509    |
| Chrome H/R w/ signal arrow                  | 716434           | 716433    | -                  | -         | -                   | -         | 716502        | 716503    |
| Black 2015 replacement head <sup>3</sup>    | -                | -         | 714256             | 714256    | -                   | -         | -             | -         |
| White 2015 replacement head <sup>3</sup>    | -                | -         | 714258             | 714258    | -                   | -         | -             | -         |
| <b>Glass Kits</b>                           |                  |           |                    |           |                     |           |               |           |
| Manual flat glass <sup>1</sup>              | -                | -         | 709407             | 709407    | -                   | -         | -             | -         |
| Htd flat, manual and htd glass              | 709448           | 709448    | 709748             | 709748    | 716104              | 716103    | 716104        | 716103    |
| Heated flat with signal arrow               | 709674           | 709673    | -                  | -         | 709994              | 709995    | 709994        | 709995    |
| Htd convex, manual and htd glass            | 709449           | 709449    | -                  | -         | 709932              | 709931    | 716106        | 716105    |
| Convex repair kit <sup>2</sup>              | 709589           | 709589    | -                  | -         | -                   | -         | -             | -         |
| Wedge stick on convex                       | -                | -         | 723068             | 723068    | -                   | -         | -             | -         |
| Flat glass retaining clip                   | -                | -         | -                  | -         | 709422              | 709422    | 709422        | 709422    |
| Convex glass retaining clip                 | -                | -         | -                  | -         | 709855              | 709855    | 709855        | 709855    |

**NOTES**

**H/R** Heated remote

<sup>1</sup> Includes bezel and wedge convex

<sup>2</sup> Includes glass, inner housing, clip and actuator

<sup>3</sup> Model 2015 replacement head only; same head used for either side



Call the Velvac Sales Team: **800.783.8871** sales@velvac.com

© VELVAC INC. • 2405 South Calhoun Road • New Berlin, WI 53151-2709 • Toll Free: 800.783.8871 • Fax: 262.786.4101

## 2020 MIRROR REPLACEMENT PARTS

### 2020XG System for GM Cut w/ 8D8 Option Replacement Mirror Heads

**Vehicle:**

GM Cutaway Van Mirrors

| Model  | Left Side # | Right Side # | Color  | Head   | Flat Glass    | Convex Glass  | Options |
|--------|-------------|--------------|--------|--------|---------------|---------------|---------|
| 2020XG | 716011      | 716012       | Black  | Deluxe | Heat / Remote | Heat / Manual | -       |
| 2020XG | 716521      | 716522       | Black  | Deluxe | Heat / Remote | Heat / Manual | Light   |
| 2020XG | 716515      | 716516       | Black  | Deluxe | Heat / Remote | Heat / Manual | Signal  |
| 2020XG | 716055      | 716056       | Chrome | Deluxe | Heat / Remote | Heat / Manual | -       |
| 2020XG | 716525      | 716526       | Chrome | Deluxe | Heat / Remote | Heat / Manual | Light   |
| 2020XG | 716519      | 716520       | Chrome | Deluxe | Heat / Remote | Heat / Manual | Signal  |

### 2020 and 2020XG Mirror Replacement Accessories

**2020 Accessories**

- **Switch Kit Ford E Van**  
Model 2020 | Part # 747524
- **Switch Kit GM G Van and C 3500**  
Model 2020 | Part # 747632
- **Switch Kit Ford F Superduty 650-750**  
Model 2020 | Part # 747633
- **12' HR Wire Harness Pass Door to Driver Door**  
Model 2020 | Part # 748304
- **Marker Light Below Elbow**  
Model 2020 | Part # 747551
- **Cover Plate Kit for GMC Topkick**  
Model 2020 | Part # 709785  
(includes plate, gasket and hardware)

**Model 2020XG & 2020SS Accessories**

- **Switch Kit Ford E Van**  
Model 2020XG | Part # 747588
- **Switch Kit GM G Van and C 3500**  
Model 2020XG | Part # 747856
- **Switch Kit Ford F Superduty 650-750**  
Model 2020XG | Part # 747901
- **12' HR Wire Harness Pass Door to Driver Door**  
Model 2020XG | Part # 747863
- **Marker Light**  
Model 2020XG | Part # 709993

**2020XG & 2020SS Accessories**

- **Black 96" Arm Cover Kit\***  
Model 2020XG | Part # 716107
- **Black 102" Arm Cover Kit\***  
Model 2020XG | Part # 716113
- **Black 96" Arm Cover Kit\***  
Model 2020XG | Part # 716109
- **Black 102" Arm Cover Kit\***  
Model 2020XG | Part # 716115

\*Kit is for a pair; includes hardware



Arm covers



Light

Harness

Switch kit

**NOTE: Part numbers listed in RED are NEW!**

# MIRRORS

## BRACKETS, CLAMPS AND ACCESSORIES



### Clamp and Tubing Arm Kits for 6", 8" and 8½" Mirror Heads

- Ideal for adding an auxiliary spot mirror to existing loop or brace
- For ¾" O.D. tubing
- Plastic coated clamp for secure grip and damage resistance
- Overall length 6"

| Part # | Description                              |
|--------|------------------------------------------|
| 723057 | Stainless steel                          |
| 748269 | UPS brown powder coated galvanized steel |



### Clamp and Tubing Arm Kit for 5" and 6" Plastic Mirror Heads

- Stainless steel formed tube arm
- Zinc plated steel clamp
- Ideal for adding an auxiliary spot mirror to existing loop or brace
- For ⅝" and ¾" O.D. tubing
- Overall length 5⅞"

| Part # | Description            |
|--------|------------------------|
| 723049 | Stainless steel tubing |



### 6" Pivot Bolt Mounting Bracket

- Ideal for adding an auxiliary spot mirror below a west coast mirror head
- Stainless steel construction
- Overall length 4⅞"

| Part # | Description               |
|--------|---------------------------|
| 723055 | For ⅝" and ¾" pivot bolts |

### "L" Style Mounting Bracket



- Sturdy ⅛", 11 gauge construction
- Pivot hole accepts ⅝" and ¾" bolts
- Slotted hole provides additional mirror head adjustment
- Ideal for mounting Velvac DuraBall® convex and all other convex mirrors

| Part # | Description     |
|--------|-----------------|
| 723100 | Stainless steel |

Replaces Velvac Part No. 723080

### Bracket Mount Mirror



- Attaches easily to west coast mirror bracket on any truck
- All stainless steel construction

| Part # | Description     |
|--------|-----------------|
| 712648 | Two arm bracket |

Bracket and hardware ONLY - mirror head sold separately

### Adjustable Tubing Arms

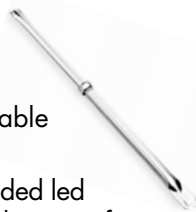

- Universal adjustable support
- 10½" long threaded led with extension adjustment from 19" to 25"
- Threaded leg can be cut to reduce minimum overall length
- Available in stainless steel and powder-coated galvanized steel finishes

| Part # | Description     |
|--------|-----------------|
| 747070 | Stainless steel |
| 747072 | Black           |

### Fender Mount Extension Bracket



- Adjustable from 13½" to 17½"
- Bell mount base provides extra support
- Stainless steel construction
- Mounting hardware included

| Part # | Description                   |
|--------|-------------------------------|
| 723047 | Fender mntd extension bracket |

Bracket and hardware ONLY - mirror head sold separately

### Sleeve and Nut Kit



- For conventional and step van brace and adjustable bracket assemblies
- Brass sleeve and chrome nut

| Part # | Description        |
|--------|--------------------|
| 748215 | Sleeve and nut kit |

### The Stabilizer Heavy-Duty Convex L-Bracket



- Unique two piece L-bracket developed in conjunction with major truck OEs
- Rigid stabilizer bracket improves image stability in convex spot mirror by reducing vibration
- Individually packaged

| Part # | Description          |
|--------|----------------------|
| 723115 | Stabilizer L-bracket |



Call the Velvac Sales Team: **800.783.8871** sales@velvac.com

© VELVAC INC. • 2405 South Calhoun Road • New Berlin, WI 53151-2709 • Toll Free: 800.783.8871 • Fax: 262.786.4101

## BRACKETS, CLAMPS AND ACCESSORIES

### Nylon Clamp Kit for 3/4" O.D. Tubing



- Non-corrosive black nylon clamp
- Recessed fasteners provide a custom look
- Kit includes clamp and hardware

| Part # | Description                                                  |
|--------|--------------------------------------------------------------|
| 748416 | Clamp kit - Includes clamp and hardware for 3/4" O.D. tubing |

### Clamp Kit for 1" O.D. Tubing



- Used to mount side and stud mount mirror heads to 1" O.D. tubing
- Plastic coating for secure grip and damage resistance
- Kit includes stainless steel clamp and mounting bolt

| Part # | Description                  |
|--------|------------------------------|
| 704070 | Clamp kit for 1" O.D. tubing |

### Standard Mounting Cabfeet Kits

- Used on non-preset style loops
- Heavy-duty 90° bracket permits a variety of mounting applications
- Cabfeet mounting holes are 2" on center
- Available in stainless steel and powder coated galvanized steel finishes
- Kits include cabfeet and hardware to mount one pair of mirrors

| Part # | Description     |
|--------|-----------------|
| 757015 | Stainless steel |
| 757016 | White           |

### Tubing Brace Clamp Kit for 3/4" O.D. Tubing



- Used to support tubing arms on loop assemblies; not used for installing mirror heads
- Kit includes stainless steel clamp and mounting hardware

| Part # | Description                                 |
|--------|---------------------------------------------|
| 748029 | Tubing brace clamp kit for 3/4" O.D. tubing |

### Clamp Kit for 3/4" O.D. Tubing



- Used to mount side and stud mount mirror heads to 3/4" O.D. tubing
- Plastic coating for secure grip and mar resistance
- Kit includes stainless steel clamp and mounting bolt

| Part # | Description                    |
|--------|--------------------------------|
| 704068 | Clamp kit for 3/4" O.D. tubing |

### Clamp Kit for 1" O.D. Tubing



- Used to add a convex mirror to a 1" O.D. tube
- All stainless steel

| Part # | Description                  |
|--------|------------------------------|
| 719263 | Clamp kit for 1" O.D. tubing |



### Flat Clamp Kit for 3/4" O.D. Tubing



- Used to mount West Coast mirror heads to 3/4" O.D. tubing - mounts on horizontal leg of loop
- Plastic coating for secure grip and damage resistance
- Kit includes stainless steel clamp and mounting hardware

| Part # | Description                         |
|--------|-------------------------------------|
| 704066 | Flat clamp kit for 3/4" O.D. tubing |

### Clamp Kit for 5/8" O.D. Tubing



- Used to mount side and center mount mirror heads to 5/8" O.D. tubing
- Kit includes two-piece aluminum clamp and stainless steel mounting hardware

| Part # | Description                    |
|--------|--------------------------------|
| 704069 | Clamp kit for 5/8" O.D. tubing |

### Twist Clamp Kit for 3/4" O.D. Tubing



- Used to mount West Coast mirror heads to 3/4" O.D. tubing - mounts on vertical leg of loop
- Plastic coating for secure grip and damage resistance
- Kit includes stainless steel clamp and mounting hardware

| Part # | Description                          |
|--------|--------------------------------------|
| 704065 | Twist clamp kit for 3/4" O.D. tubing |

**NOTE: Part numbers listed in RED are NEW!**

# MIRRORS

## BRACKETS, CLAMPS AND ACCESSORIES



### Non-Preset Pivot Kit

- Replacement kit for mirrors with Velvac non-preset pivot end and Velvac mirrors with standard pivot
- 5/16" - 18 x 1" stainless steel bolt
- Kit contains parts for one complete non-preset pivot end

| Part # | Description          |
|--------|----------------------|
| 748012 | Non-preset pivot kit |



### Rubber Preset Pivot Kit

- Replacement kit for mirrors with Velvac rubber preset pivots and Velvac mirrors with rubber washer style preset
- 5/16" - 18 x 1 1/2" stainless steel bolt
- Kit contains parts for one complete preset pivot end

| Part # | Description             |
|--------|-------------------------|
| 748009 | Rubber preset pivot kit |

### Switch Kit for Heated Mirrors



- Dash mounted kit controls one to two heated mirror heads

| Part # | Description                  |
|--------|------------------------------|
| 747053 | Switch kit for heated mirror |

### Clamp, Brace & Bracket Kit

- Ideal for adding auxiliary spot mirrors to existing loop or brace



### Spring Preset Pivot Kit

- Replacement kit for mirrors with standard Velvac spring preset systems and UPS walk-in vans with Velvac mirrors
- Use to upgrade mirrors with rubber washer preset to a spring preset for improved pivot action
- Stainless steel rivet plate extends life of loop and improves pivot action on mirrors with worn preset rivets
- 5/16" - 18 x 2" stainless steel bolt
- Kit contains parts for one complete spring preset pivot end

| Part # | Description             |
|--------|-------------------------|
| 712979 | Spring preset pivot kit |



### Preset Rivet Plate

- Designed for use on all Velvac preset loops except those with tension control stop preset as found in kit Part No. 748371
- Two stainless steel rivet plates extend life of loop and improve pivot action on mirrors with worn preset rivets
- Mounts easily between existing mirror loop and preset lock plate

| Part # | Description            |
|--------|------------------------|
| 748377 | Preset rivet plate kit |



| Part # | Description                   |
|--------|-------------------------------|
| 723091 | Clamp, tubing arm & L bracket |



### Heavy-Duty Preset and Pivot Upgrade Kit

- Designed for use on all Velvac preset loops except those with tension control stop preset as found in kit Part No. 748371
- Improves pivot holding force on mirrors with large loops or large / heavy mirror head combinations
- Unique spring / washer combination retains pivot system torque to keep mirror in set viewing position until moved and provides superior detent action for foldaway applications
- Life cycle tested to over 50,000 pivot cycles
- Preset rivet plate fits over existing preset rivets to extend life of loop and improve cycle performance
- Easy retrofit - can be completed without taking mirror assembly off the vehicle
- 5/16" - 18 x 1 3/4" stainless steel pivot bolt and 5/16" - 18 x 2" stainless steel preset bolt
- Kit contains all upper and lower pivot hardware for one mirror assembly

| Part # | Description                             |
|--------|-----------------------------------------|
| 748355 | Heavy-duty preset and pivot upgrade kit |

\*Order one Part No. 748355 per side

#### Helpful hint:

Kit can be used to upgrade mirror loops with standard rubber or spring preset systems (similar to Part No. 748009 or 712979 detailed on this page)

Call the Velvac Sales Team: **800.783.8871** sales@velvac.com

© VELVAC INC. • 2405 South Calhoun Road • New Berlin, WI 53151-2709 • Toll Free: 800.783.8871 • Fax: 262.786.4101

**OUR PARTS PUT YOU IN THE PASSING LANE**

# VISION SYSTEMS

## The future is here.

Velvac has developed some of the most sophisticated vision systems in the industry. With the addition of both Road-iQ and 5th Wheel Dual Camera system to our line-up, you'll find that we're at the forefront in ensuring safety for drivers.

- **AeroCam**
- **Road-iQ**
- **5th Wheel Dual Camera**



Includes:



# VISION SYSTEMS

## CAMERA SYSTEMS

- Velvac offers a variety of camera systems and kits to increase safety and convenience
- Below camera placement can also be for straight trucks, RVs, buses and speciality vehicles

### Helpful hint:

Be mindful of the connection type. The connectors are one of two types: A and B, shown to the right. All pieces must be compatible or will require the use of an adaptor



4-pin  
'A' Connection



5-pin  
'B' Connection



Road-iQ  
System  
Page V14



Front View  
Camera  
Page V5



Interior  
Camera  
Page V5



Back-Up  
Camera  
Page V3

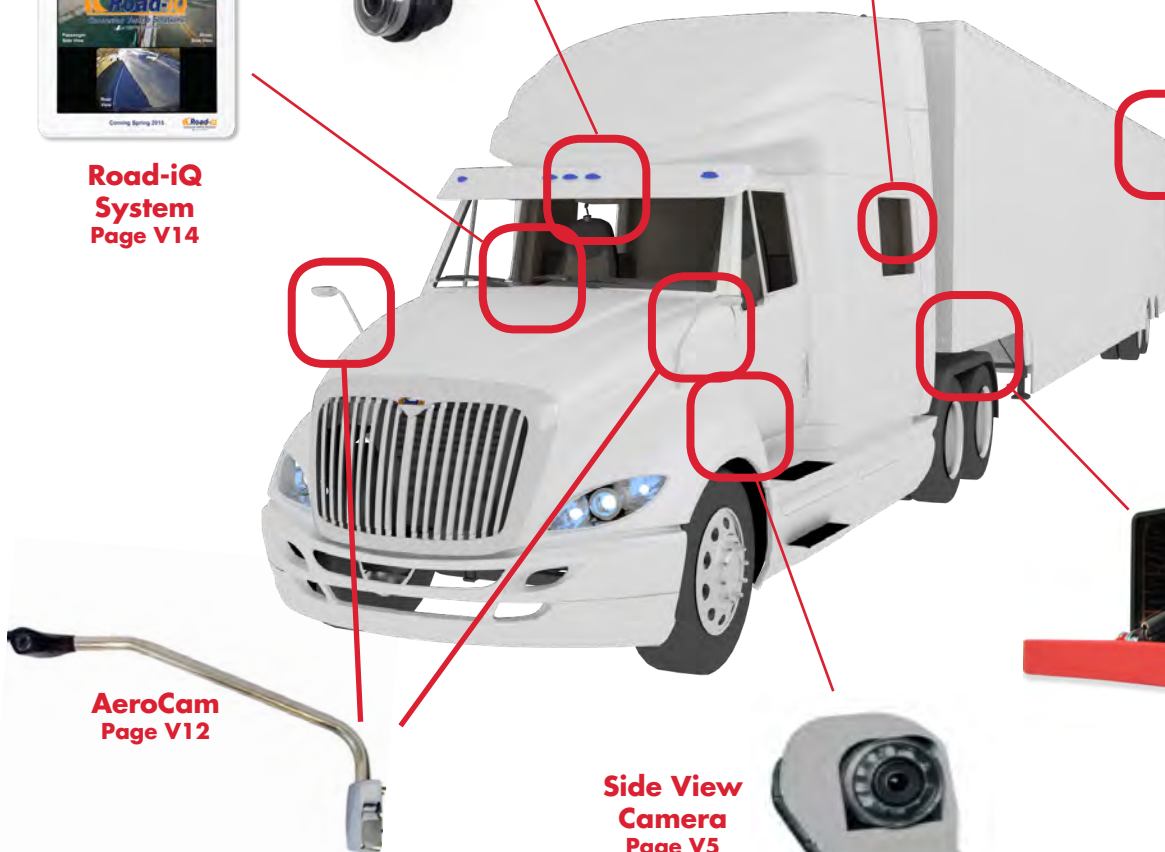

AeroCam  
Page V12



Side View  
Camera  
Page V5



5th Wheel  
Dual Camera  
Page V11



Call the Velvac Sales Team: **800.783.8871** [sales@velvac.com](mailto:sales@velvac.com)

© VELVAC INC. • 2405 South Calhoun Road • New Berlin, WI 53151-2709 • Toll Free: 800.783.8871 • Fax: 262.786.4101



## CAMERAS

### Rear View Cameras



717973



710615

### Flush Mount Rear View Camera

| Part # | FOV           | Connector | IP Rating | Power  |
|--------|---------------|-----------|-----------|--------|
| 717973 | 120° H, 90° V | B         | IP69K     | 12 VDC |
| 710615 | 120° H, 90° V | A         | IP69K     | 12 VDC |

- Velvac offers a variety of rear view cameras including the exclusive flush mount back-up camera and adjustable back-up style



710522



710521



710523



710326

### Adjustable Rear View Camera

| Part # | Housing | FOV           | Connector | IP Rating | Power  |
|--------|---------|---------------|-----------|-----------|--------|
| 710522 | White   | 123° H, 95° V | A         | IP69K     | 12 VDC |
| 710523 | Black   | 112° H, 80° V | A         | IP69K     | 12 VDC |
| 710521 | Black   | 120° H, 90° V | A         | IP69K     | 12 VDC |
| 710326 | Black   | 80° H, 60° V  | B         | IP69K     | 12 VDC |

- Integrated flush mount provides clean appearance with no exposed wires or hardware
- Camera angle is preset to provide the optimum visibility with no needed adjustments
- IR-LED
- CMOS technology reduces blooming
- Includes durable backing plate, gasket and mounting hardware

#### 710522, 710521, 710523

- Built-in microphone for enhanced safety with audio output (through the monitor) while backing up
- Waterproof housing
- IR-LED
- CMOS image technology (710522 uses CCD technology)
- Aluminum bracket and stainless steel mounting hardware included

#### 710326

- IR-LED
- CMOS technology reduces blooming
- Mounting bracket and hardware included

#### NOTES

- CMOS** Complimentary metal oxide semiconductor
- CCD** Charged couple device
- Blooming** Glare due to sunlight, headlight conditions, etc.

**NOTE: Part numbers listed in RED are NEW!**

## CAMERAS

### Side View Cameras

- Velvac offers both traditional mount side view cameras and hood mount AeroCams, as well as side view CMOS cameras integrated into the Velvac 2020 Mini-LEM and V-MAX and V-MAX III LEM mirror systems (see page M37). Also featuring an integrated camera is the MirrorCam, part of the LaneOptics hood mount mirror series (see page M26).



AeroCam  
Post Cam

Short Arm  
AeroCam

### AeroCam Post Cams

| Right Side # | Left Side # | FOV            | Connector | IP Rating | Power  |
|--------------|-------------|----------------|-----------|-----------|--------|
| 717994       | 717993      | 73.7° H, 61° V | B         | IP69K     | 12 VDC |
| 717994-5     | 717993-5    | 73.7° H, 61° V | A         | IP69K     | 12 VDC |

#### AeroCam Post Cam

- Post Cam kits include both ¾" O.D. and 1" O.D. SS tube clamps for unlimited mounting options
- 1" clamp wraps around camera post for easy mounting to almost any surface
- ¾" and 1" clamps can be nested together to allow Post Cam to mount to ¾" tubular hood or side mount mirrors
- Includes (2) 15' camera cables for routing to monitor or recording device
- Note: Camera must be mounted horizontally for proper camera view

### Short Arm AeroCams

| Right Side # | Left Side # | FOV            | Connector | IP Rating | Power  |
|--------------|-------------|----------------|-----------|-----------|--------|
| 717870       | 717869      | 73.7° H, 61° V | B         | IP69K     | 12 VDC |
| 717992       | 717991      | 73.7° H, 61° V | A         | IP69K     | 12 VDC |

#### Short Arm AeroCam

- Easily attaches to any flat vertical surface
- Applications include: walk in van, refuse truck, yard tractor, fire truck
- Black powder coated tube arm and mounting base
- Includes mounting hardware and universal backing plates
- Base mounting pattern is 2" x 3.75"



#### NOTES

For complete AeroCam kits with monitors see pages V12 - V13

### AeroCam

| Pair # | Vehicle Model             | FOV          | Connector | IP Rating | Power  |
|--------|---------------------------|--------------|-----------|-----------|--------|
| 717971 | Volvo VNL                 | 81° H, 61° V | B         | IP69K     | 12 VDC |
| 717901 | Volvo VNM                 | 81° H, 61° V | B         | IP69K     | 12 VDC |
| 717878 | Kenworth T700             | 81° H, 61° V | B         | IP69K     | 12 VDC |
| 717897 | All other PACCAR vehicles | 81° H, 61° V | B         | IP69K     | 12 VDC |
| 717953 | Freightliner Cascadia     | 81° H, 61° V | B         | IP69K     | 12 VDC |

#### AeroCam

- AeroCam pair includes right and left side AeroCams, cables and hardware



Call the Velvac Sales Team: **800.783.8871** sales@velvac.com

## CAMERAS



Rear & Side View Camera



Rear View Camera

### Rear & Side View Cameras

- Sleek design protects camera from dirt and contamination
- IR-LED
- CMOS technology reduces blooming
- Mounting bracket and hardware included

| Part # | Side  | Housing     | FOV          | Connector | IP Rating | Power  |
|--------|-------|-------------|--------------|-----------|-----------|--------|
| 709941 | Left  | Gray primer | 95° H, 75° V | A         | IPX7      | 12 VDC |
| 709942 | Right | Gray primer | 95° H, 75° V | A         | IPX7      | 12 VDC |
| 709949 | Left  | Chrome      | 95° H, 75° V | A         | IPX7      | 12 VDC |
| 709948 | Right | Chrome      | 95° H, 75° V | A         | IPX7      | 12 VDC |
| 710325 | Rear  | Black       | 80° H, 60° V | B         | IP69K     | 12 VDC |

### Rear View Camera

- High resolution color
- Waterproof housing
- Cylindrical 3/4" through hole mount
- IR-LED
- CMOS technology reduces blooming



### Front Facing Cameras

- High resolution color
- Waterproof housing
- Mounts on top or bottom of windshield
- CMOS technology reduces blooming

| Part # | FOV           | Connector | IP Rating | Power  |
|--------|---------------|-----------|-----------|--------|
| 717871 | 120° H, 90° V | B         | IP69K     | 12 VDC |



### Interior Cameras

- High resolution color
- IR-LED
- CCD image technology
- Mounting hardware included

| Part # | FOV           | Connector | IP Rating | Power  |
|--------|---------------|-----------|-----------|--------|
| 710589 | 120° H, 90° V | B         | N/A       | 12 VDC |

#### NOTES

**CMOS** Complimentary metal oxide semiconductor

**CCD** Charged couple device

**NOTE: Part numbers listed in RED are NEW!**

## MONITORS

- Velvac's color 5.6" and 7" LCD monitors are designed for heavy duty and commercial truck applications - built and tested to withstand extreme road conditions such as vibrations, electrostatic discharge, humidity and temperature changes and to deliver high quality images to the driver
- 5.6" and 7" monitors include audio speaker with volume
- 5" monitor has full camera views
- 7" monitor has 8 different view modes; view 1 to 4 cameras at a time
- Velvac's 3.5" color monitor in a rear view mirror provides the ultimate in safety and convenience. The image is invisible while in drive and only activates when the camera trigger is engaged



709915



710723



716314



710323



710324

### NOTES

- <sup>1</sup> Requires the addition of mounting brackets shown on page V7
- <sup>2</sup> Includes multi-image view modes: split screen (2-way), tri-view (3-way), and quad view (4-way); all other monitors have single screen viewing

| Part #              | Screen         | Camera Inputs | Triggers    | Mounting             | Connector | Power |
|---------------------|----------------|---------------|-------------|----------------------|-----------|-------|
| 709915 <sup>1</sup> | 5.6" Color LCD | 2             | 2           | 4-hole amps pattern  | A         | 12VDC |
| 710723              | 7" Color LCD   | 4             | 4 + 1 split | T-slot               | A         | 12VDC |
| 716314              | 3.5" Color LCD | 3             | 3           | Universal windshield | A         | 12VDC |
| 710323              | 5" Color LCD   | 3             | 3           | Bracket included     | B         | 12VDC |
| 710324              | 7" Color LCD   | 4             | 4           | Bracket included     | B         | 12VDC |

### Three Camera Controller

- Allows 716314 camera input monitor to be converted to accept (3) cameras simultaneously
- This controller allows different views to automatically engage based on triggers for left / right turn signals or reverse
- This flexible control box can be wired for full time viewing of the rear camera if needed



| Part # | Description             | Connector |
|--------|-------------------------|-----------|
| 716318 | Three camera controller | A         |



Call the Velvac Sales Team: **800.783.8871** [sales@velvac.com](mailto:sales@velvac.com)

## MONITOR MOUNTS

| Part # | Description                                                                   |
|--------|-------------------------------------------------------------------------------|
| 790563 | 4" Single knuckle monitor mount (4-hole amps pattern) bracket with thumbscrew |
| 790564 | 6" Double knuckle monitor mount (4-hole amps pattern) bracket with thumbscrew |
| 790576 | Double knuckle monitor mount for 1" ball (4-hole amps pattern)                |
| 790605 | Double knuckle monitor mount (T slot)                                         |



790563



790564



790576



790605

## CABLES

- Cables can be connected together to create various lengths
- Cable quantity and length will vary based on number of cameras and distance from camera to monitor
- Tractor to trailer camera cable kit includes all necessary straight and coiled cables to connect truck monitor to back up camera on top of trailer – the coiled cable is designed to safely span area between tractor and trailer

| Part # | Description                          | Connector |
|--------|--------------------------------------|-----------|
| 747850 | 15' Camera to monitor cable          | A         |
| 745243 | 15' Camera to monitor cable          | B         |
| 747864 | 25' Camera to monitor cable          | A         |
| 745244 | 25' Camera to monitor cable          | B         |
| 747865 | 34' Camera to monitor cable          | A         |
| 745245 | 34' Camera to monitor cable          | B         |
| 747866 | 50' Camera to monitor cable          | A         |
| 747867 | 75' Camera to monitor cable          | A         |
| 745142 | Camera splitter / Y-cable            | B         |
| 745137 | 12" DVR adapter cable, B male / BNC  | B         |
| 745138 | 12" DVR to camera cable              | B         |
| 745252 | Tractor to trailer camera cable kit* | B         |

\*Kit includes coiled cable assembly with plug connectors, mating sockets for truck and tractor, 33' of camera cable for routing to truck monitor and 65' of camera cable for routing to back of trailer / back up camera



'A' connector cable



'B' connector cable



Tractor to trailer camera cable

### Adaptor

- Use adaptor to connect A cameras to the B monitors (page V6)

| Part # | Description | Connector |
|--------|-------------|-----------|
| 747894 | Adaptor     | A ---> B  |

**NOTE: Part numbers listed in RED are NEW!**

## CAMERA KITS

### Back-Up Camera Kits

- CMOS / IR-LED camera
- 5" Monitor with 3 camera inputs



| Kit Part # | Camera | Monitor | Cables Included | Total Cable Length |
|------------|--------|---------|-----------------|--------------------|
| 719598     | 710326 | 710323  | 1 - 34'         | 34'                |
| 719599     | 710326 | 710323  | 2 - 25'         | 50'                |
| 719600     | 710326 | 710323  | 2 - 34'         | 68'                |

- CMOS / IR-LED camera
- 7" monitor has 8 different view modes; view 1 to 4 cameras at a time
- 4 Camera inputs



| Kit Part # | Camera | Monitor | Cables Included | Total Cable Length |
|------------|--------|---------|-----------------|--------------------|
| 719601     | 710326 | 710324  | 1 - 34'         | 34'                |
| 719602     | 710326 | 710324  | 2 - 25'         | 50'                |
| 719603     | 710326 | 710324  | 2 - 34'         | 68'                |



Call the Velvac Sales Team: **800.783.8871** [sales@velvac.com](mailto:sales@velvac.com)

## CAMERA KITS



- For use with PACCAR SmartNav and NavPlus systems
- CMOS / IR-LED camera

| Kit Part # | Camera | Cables Included | Total Cable Length |
|------------|--------|-----------------|--------------------|
| 719612     | 710326 | 2 - 25'         | 50'                |

## Side View Camera Kits



- CMOS / IR-LED camera
- 5" Monitor with 3 camera inputs

| Kit Part # | Camera | Monitor | Cables Included | Total Cable Length |
|------------|--------|---------|-----------------|--------------------|
| 719592     | 710325 | 710323  | 1 - 34'         | 34'                |
| 719593     | 710325 | 710323  | 2 - 25'         | 50'                |
| 719594     | 710325 | 710323  | 2 - 34'         | 68'                |

## CAMERA KITS

### Side View Camera Kits



- CMOS / IR-LED camera
- 7" monitor has 8 different view modes; view 1 to 4 cameras at a time
- 4 Camera inputs



| Kit Part # | Camera | Monitor | Cables Included | Total Cable Length |
|------------|--------|---------|-----------------|--------------------|
| 719595     | 710325 | 710324  | 1 - 34'         | 34'                |
| 719596     | 710325 | 710324  | 2 - 25'         | 50'                |
| 719597     | 710325 | 710324  | 2 - 34'         | 68'                |



- CCD / IR-LED camera
- 7" monitor
- 4 Camera inputs
- 4" Single knuckle monitor mount

| Kit Part # | Camera | Monitor | Monitor Mount | Cables Included | Total Cable Length |
|------------|--------|---------|---------------|-----------------|--------------------|
| 709954     | 710522 | 710723  | 790563        | 1 - 34'         | 34'                |



- CCD / IR-LED camera
- 7" monitor
- 3 Camera inputs
- 4" Single knuckle monitor mount

| Kit Part # | Camera | Monitor | Monitor Mount | Cables Included | Total Cable Length |
|------------|--------|---------|---------------|-----------------|--------------------|
| 709921     | 710522 | 709915  | 790563        | 1 - 34'         | 34'                |



Call the Velvac Sales Team: **800.783.8871** [sales@velvac.com](mailto:sales@velvac.com)



## 5TH WHEEL DUAL CAMERA SYSTEM



The 5th Wheel Dual Camera System allows drivers to properly line up the king pin and fifth wheel, making coupling easier and preventing costly damage to the tractor or trailer

- Doors open automatically when vehicle is placed in reverse
- Dual cross hair cameras provide the driver with a clear view of king pin and fifth wheel alignment
- Heavy duty aluminum housing and reinforced molded doors help protect cameras from rain, snow and debris
- Integrated heating system allows for cold weather operation
- IR camera assists backing in low or no light conditions
- Mounting brackets are designed to fit a wide variety of vehicle applications
- Kits include dual camera, cables, hardware and installation information

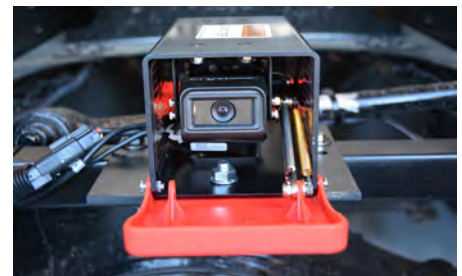

### 5th Wheel Dual Camera Kit

| Part #   | Monitor | Mounting Bracket | Vehicle   |
|----------|---------|------------------|-----------|
| 710640   | •       | -                | All       |
| 710640-1 | •       | •                | All       |
| 710640-3 | •       | •                | Kenworth  |
| 710640-4 | •       | •                | Kenworth* |
| 710651   | -       | -                | All       |
| 710651-1 | -       | •                | All       |
| 710651-3 | -       | •                | Kenworth  |

### Service Parts

| Part #   | Description                      |
|----------|----------------------------------|
| 710641   | Camera enclosure                 |
| 745241   | Wire harness                     |
| 710649   | Control module                   |
| 710324   | 7" Monitor                       |
| 351108** | Mounting bracket                 |
| 351109   | Mounting bracket (Kenworth only) |
| 745245   | 34' Camera cable                 |

- Velvac offers kits with two different mounting brackets for easy installation
- Kenworth brackets are for use on Kenworth trucks only
- Universal bracket fits all other vehicle applications except for Paccar trucks\*\*

#### NOTES

\* Compatible with Kenworth drop wire option package 8700919

\*\* Contact Velvac for information on Paccar mounting brackets

# VISION SYSTEMS

## AEROCAM VISION SYSTEM

### AeroCam Vision System

- Blind spot elimination system for heavy duty trucks
- The Velvac AeroCam is a camera-based vision system that provides the driver with clear views of blind spots and passing lanes around the vehicle, resulting in improved safety and reduced potential for costly and dangerous accidents
- According to National Highway Transportation Safety Administration (NHTSA), depth perception and object recognition are the keys to safe vehicle operation. With an optimal 65° viewing angle, CMOS vision processor and camera positioned above the splash zone, the AeroCam system clearly displays the most critical vision targets, allowing the driver to make faster and safer driving decisions. With its smaller profile in relation to conventional convex mirrors, the AeroCam is also designed to reduce drag, resulting in improved vehicle aerodynamics, a major contributor to improving fuel economy and reducing fuel consumption



**AeroCam Optimized  
65° Horizontal FOV**

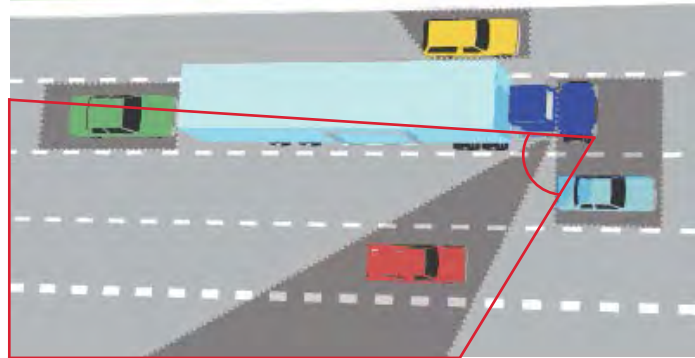

Custom kits for PACCAR and Volvo vehicles are designed for specific hood geometry and wire routing



1" OD stainless steel tubing arm can be rotated for fine camera angle adjustment. Also rotates upon impact to reduce the potential damage



Available with right side and left side dedicated dash mounted monitors as shown above



Call the Velvac Sales Team: **800.783.8871** [sales@velvac.com](mailto:sales@velvac.com)

© VELVAC INC. • 2405 South Calhoun Road • New Berlin, WI 53151-2709 • Toll Free: 800.783.8871 • Fax: 262.786.4101

## AEROCAM VISION SYSTEM

| Vehicle Model                    | Pair # | Right Side # | Left Side # | 5" Monitor   | 7" Monitor |
|----------------------------------|--------|--------------|-------------|--------------|------------|
| Volvo VNL                        | 717823 | -            | -           | 2            | -          |
|                                  | 717825 | -            | -           | -            | 1          |
|                                  | 717824 | 717826       | 717827      | 1            | -          |
|                                  | -      | 717812       | 717811      | AeroCam Only |            |
| Volvo VNM                        | 717828 | -            | -           | 2            | -          |
|                                  | 717830 | -            | -           | -            | 1          |
|                                  | 717829 | 717832       | 717831      | 1            | -          |
|                                  | -      | 717812       | 717811      | AeroCam Only |            |
| Kenworth T700                    | 717813 | -            | -           | 2            | -          |
|                                  | 717815 | -            | -           | -            | 1          |
|                                  | 717814 | 717816       | 717817      | 1            | -          |
|                                  | -      | 717810       | 717809      | AeroCam Only |            |
| Kenworth T700 w/ Nav             | 719635 | 719636       | 719637      | -            | -          |
|                                  | -      | 717810       | 717809      | AeroCam Only |            |
| All other PACCAR vehicles        | 717818 | -            | -           | 2            | -          |
|                                  | 717820 | -            | -           | -            | 1          |
|                                  | 717819 | 717822       | 717821      | 1            | -          |
|                                  | -      | 717810       | 717809      | AeroCam Only |            |
| All other PACCAR vehicles w/ Nav | 719632 | 719634       | 719633      | -            | -          |
|                                  | -      | 717810       | 717809      | AeroCam Only |            |

### AeroCam Features

- Provides a clear view along the side of the truck and trailer to reduce blindspots and improve driver safety
- Optimized camera field of view provides better depth perception with less distortion: objects in blind spots appear larger and are easier to recognize on the color monitor
- Chrome plated aluminum mounting base with four hole mounting pattern for fast and easy installation. The same hole pattern as Velvac Pod and Mod Pod mirrors makes for easy retro-fits
- CMOS camera technology produces superior imaging and accurate colors even in extreme light conditions and harsh weather
  - » 40° to 85°C / -40° to 185°F
  - » Built-in anti-blooming protection to maintain visibility under sunlight, glare and headlight conditions
  - » Superior depth perception
  - » Vibrant colors and clarity
  - » Integrates seamlessly into the Kenworth NavPlus® and Peterbilt SmartNav™ monitors
- For a complete solution, Road-iQ and additional cameras can be integrated for full coverage
- FOV: 65° Horizontal, 55° Vertical
- IP Rating: IP69K

- Pair include right and left side AeroCams, monitor(s), cables and hardware
- Sides include right side or left side AeroCams, monitor, cables and hardware
- AeroCam Only is right side or left side AeroCam only; no monitor or hardware is included



NavPlus with Image from AeroCam



## Road-iQ Vision System



Road-iQ is a connected vehicle technology that integrates a powerful video processor, up to 7 cameras, a unique telematics server platform and a tablet with the Road-iQ Connect app to provide a range of features to help you drive safer and smarter.

### Components

#### 1. Video Data Server (VDS)

The heart of the Road-iQ system. It collects and manages videos, tagged events and vehicle data for display and recording/playback of notable events. The VDS supports the most powerful range of vehicle monitoring capabilities available including J1939, OBD II, CAN, ethernet, USB, GPIO and LIN for control and recording of vehicle functions.

#### Camera Configuration Example

**2. Forward/Driver Facing Camera** See page V5

**3. Rear Facing Camera** See page V3

**4. Hood Mount Cameras**

a. **MirrorCam** See page M26

b. **AeroCam** See page V4

#### Optional Add-Ons

#### 5. NetHub

Enables cellular and Wi-Fi connection from the VDS to the cloud for access to the Road-iQ portal for live stream video analysis, recorded event viewing, data archiving, vehicle diagnostics and trip reporting.

**6. 5th Wheel Dual Camera System** See page V11



### Features



#### 360° Views

Coverage of your blind spots in any driving conditions.



#### Vehicle Recording

Capture all events from any of your vehicles' cameras.



#### Remote Video Access

Check on your vehicle from anywhere via the Road-iQ portal.



#### Vehicle Diagnostics

Specific fault descriptions alert driver and fleet managers of potential vehicle problems.



#### Flexible Display

Connect to an iPad or iPhone for viewing in cab by the driver.



Call the Velvac Sales Team: **800.783.8871** [sales@velvac.com](mailto:sales@velvac.com)

## Road-iQ Vision System



### How It Works



Connect any 6 cameras



VDS connects to J1939 or OBD II on vehicle

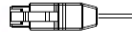

NetHub provides Wi-Fi hotspot and 4G LTE connection to the cloud



Display live camera views on a tablet or monitor for safer driving, along with local recording and playback of video

### Remote Viewing: The Portal

The NetHub (pictured above) allows for 4G LTE connectivity and a Wi-Fi hotspot for uploading video from all cameras. Simply log on to the online portal to remotely view a vehicle's real time footage, events, location and diagnostics.

### Live Viewing



## Road-iQ Vision System



### The Portal

#### Event Browsing

| Event Type | Count |
|------------|-------|
| HA         | 51    |
| LS         | 24    |
| HZ         | 3     |
| HB         | 64    |
| ST         | 14    |
| UE         | 21    |
| GN         | 43    |
| GO         | 56    |

| Event Description | Vehicle | Speed (Mph) | Event Date (US/Central)  | Transfer Date (US/Central) |
|-------------------|---------|-------------|--------------------------|----------------------------|
| Hard Braking      | 101953  |             | Mar 21, 2018, 7:55:05 AM | Mar 22, 2018, 3:07:51 AM   |
| Hard Acceleration | 161953  |             | Mar 19, 2018, 5:42:15 PM |                            |
| Hard Braking      | 325403  |             | Mar 19, 2018, 5:33:53 PM | Mar 22, 2018, 3:07:56 AM   |

#### Geotracking

#### Fleet Monitoring

| Last Connection Time | Name   | Sub Company | Recent Events | Active DTCs |
|----------------------|--------|-------------|---------------|-------------|
| 1 month              | 325164 | -           | 0             | 1           |
| 1 month              | 325246 | -           | 0             | 0           |
| 1 month              | 325247 | -           | 0             | 0           |
| 1 month              | 325248 | -           | 0             | 0           |
| 1 month              | 325401 | -           | 0             | 0           |
| 1 month              | 325403 | -           | 0             | 0           |
| 1 month              | 325718 | -           | 0             | 0           |
| 1 month              | 325719 | -           | 0             | 0           |

For more information, contact our sales team



Call the Velvac Sales Team: **800.783.8871** [sales@velvac.com](mailto:sales@velvac.com)

© VELVAC INC. • 2405 South Calhoun Road • New Berlin, WI 53151-2709 • Toll Free: 800.783.8871 • Fax: 262.786.4101

# HOSE SUPPORT

**Hose and cable support accessories.**

Velvac has the pogo sticks and suspenders you need to organize your hoses and cables to get maximum life from these vital components.

- Pogo sticks
- Springs & handles
- Hose & cable accessories



# HOSE SUPPORT

## HOSE AND CABLE SUPPORT ACCESSORIES



### Hose & Cable Suspenders

- Molded of durable rubber components which remain flexible to -40°F
- Will not stretch out or corrode like traditional steel support springs
- Reduce damage to cab body paint
- 3/4" diameter holes
- For use with hose brackets, pogo sticks and slide bars

| Part # | Overall Length |
|--------|----------------|
| 580081 | 5"             |
| 580082 | 12"            |
| 580086 | 16"            |
| 580094 | 24"            |



580037, 580043



580038



580039



### Slide Bar & Hose Suspenders Kit

- Slide bar is 3/4" O.D. stainless steel tubing with 42-1/2" mounting centers
- Kit includes slide bar, 24" hose and cable sponder, nylon ring and zinc-plated steel "S" hook

| Part # | Description                    |
|--------|--------------------------------|
| 580066 | Complete kit                   |
| 580078 | Replacement ring with "S" hook |
| 580067 | Replacement slide bar          |
| 580076 | "S" hook                       |



580040

### Hose Holders & Separators

- ABS plastic construction

| Part # | I.D. | Description      |
|--------|------|------------------|
| 580043 | 1/2" | 2 Hose separator |
| 580037 | 3/8" | 2 Hose separator |
| 580038 | 3/8" | 4 Hose separator |
| 580039 | 3/4" | 2 Hose separator |
| 580040 | .62" | 3 Hose separator |
| 580041 | .62" | 4 Hose separator |



Replacement tracker bar kit

### Replacement Tracker Bar Kits

Tracker bar tender kits are designed to hold air lines and electrical cables to prevent kinks and abrasions during normal highway use.

#### KIT INCLUDES:

- **16" or 20" Spring:** plated for added corrosion resistance and double looped ends for additional strength
- **Snap clip:** rust resistant stainless steel which clips easily onto a tracker bar or pogo stick
- **3 Hose holder assembly:** neatly holds two air hoses and an electrical cable
- **Velvac woven mesh jacket:** protects spring from the elements while giving a clean look

| Part # | Description               |
|--------|---------------------------|
| 580111 | Kit with 16" spring       |
| 580112 | Kit with 20" spring       |
| 580107 | Stainless steel snap clip |



580041

**NOTE: Part numbers listed in RED are NEW!**



Call the Velvac Sales Team: **800.783.8871** sales@velvac.com



# HOSE SUPPORT

## HOSE AND CABLE SUPPORT ACCESSORIES



### Replacement Clamp

- Replaces hanger clamp for 3-in-1 or 4-in-1 air/electrical combo

| Part # | Description       |
|--------|-------------------|
| 580044 | Replacement clamp |



### Hose Support Springs

- Springs support either air or vacuum lines
- Heat-treated and zinc plated spring steel construction provides corrosion resistance
- Double wire loop ends add extra strength

| Part # | Description            |
|--------|------------------------|
| 038001 | 3/4" O.D. x 13" long   |
| 038003 | 1" O.D. x 13" long     |
| 038008 | 1-1/8" O.D. x 8" long  |
| 038005 | 1-1/8" O.D. x 28" long |



### Grab Handles

- 3/4" O.D. heavy gauge stainless steel tubing
- 5/16" diameter mounting holes

| Part # | Description | Grabbing Width |
|--------|-------------|----------------|
| 690021 | 12" Span    | 3"             |
| 690022 | 18" Span    | 2"             |
| 690023 | 24" Span    | 2"             |

NOTE: Span measurement taken between mounting holes

## POGO STICKS



| Part #   | Description                          | Size |
|----------|--------------------------------------|------|
| 581100   | Zinc and yellow dichromate           | 24"  |
| 581100-5 | Zinc and yellow dichromate w/ holder | 24"  |
| 581101   | Zinc and yellow dichromate           | 40"  |
| 581101-5 | Zinc and yellow dichromate w/ holder | 40"  |
| 581106   | Zinc and yellow dichromate           | 50"  |
| 581106-5 | Zinc and yellow dichromate w/ holder | 50"  |
| 581102   | Chrome                               | 24"  |
| 581102-5 | Chrome w/ holder                     | 24"  |
| 581103   | Chrome                               | 40"  |
| 581103-5 | Chrome w/ holder                     | 40"  |
| 581107   | Chrome                               | 50"  |
| 581107-5 | Chrome w/ holder                     | 50"  |
| 581104   | Stainless steel                      | 24"  |
| 581104-5 | Stainless steel w/ holder            | 24"  |
| 581105   | Stainless steel                      | 40"  |
| 581105-5 | Stainless steel w/ holder            | 40"  |

# HOSE SUPPORT

## POGO STICKS

- Durable, powder coated steel bodies provide excellent support for air, vacuum and electrical lines
- Snubber chain assembly helps prevent pogo stick from coming in contact with cab
- Heavy-duty, e-coated, oil-tempered steel springs can withstand 90° from vertical bends
- 5/8" - 11 stud and nut for extra support
- Heavy fabric hose holder strap included where pictured



Hose and cable suspender  
US Patent No. 4,358,082



*NO SNUBBER CHAIN  
for use only when  
pogo stick is at  
least 24" away  
from cab*

- Combines popular 40" pogo stick with 5" rubber hose and cable suspender
- Adapter kit retrofits 5" hose and cable suspender on existing pogo sticks and includes "S" hook and eyebolt hardware (9/32" hole is required for installation of eyebolt)

| Part # | Description                                           |
|--------|-------------------------------------------------------|
| 581001 | 40" Pogo stick with snubber chain                     |
| 581005 | 40" Pogo stick with gladhand holder and snubber chain |
| 581006 | Gladhand holder kit                                   |

| Part # | Description                         |
|--------|-------------------------------------|
| 581011 | 40" Pogo stick                      |
| 581015 | 40" Pogo stick with gladhand holder |
| 581006 | Gladhand holder kit                 |

| Part # | Description                                               |
|--------|-----------------------------------------------------------|
| 581040 | Pogo stick and hose suspender assembly with snubber chain |
| 581038 | Hose and cable adapter kit                                |



Call the Velvac Sales Team: **800.783.8871** [sales@velvac.com](mailto:sales@velvac.com)

**OUR PARTS PUT YOU IN THE PASSING LANE**

# AIR

## High quality air components.

From gladhands to slack adjusters to seat valves, Velvac is your full system provider for critical and convenient air components for your commercial vehicle.

- Extensive line-up of air products
- TS-certified manufacturers
- Exceeds industry specifications



## GLADHANDS

### Iron Gladhands with Polyurethane Seals



- Solid, one-piece construction
- Service and emergency gladhand color-coated for easy identification
- Color-coded polyurethane seal
- Positive, spring loaded locking mechanism keeps gladhand properly positioned
- 1/2" FPT port
- Meets SAE J318 specs including breakaway requirement

**Lifetime guarantee covers both gladhands and seals!**

| Part # | Description                                   |
|--------|-----------------------------------------------|
| 035031 | Universal gladhand w/ black polyurethane seal |
| 035032 | Emergency gladhand w/ red polyurethane seal   |
| 035033 | Service gladhand w/ blue polyurethane seal    |

### Shutoff Gladhands

- Lightweight die cast aluminum bodies
- Clamp plates are color-coded for easy identification
- Polyurethane seal included
- 1/2" or 3/8" nylon air tube fitting
- Emergency gladhand with 1/4" - 18NPT port for pindle hook air line fitting
- Meets SAE J318 requirements



| Part # | Description             |
|--------|-------------------------|
| 035094 | 3/8" Service gladhand   |
| 035095 | 3/8" Emergency gladhand |
| 035173 | 1/2" Service gladhand   |
| 035174 | 1/2" Emergency gladhand |

### Premium Powder Coated Gladhand



- Available in service and emergency color coding
- Powder coated aluminum improves corrosion resistance
- Polyurethane seals improve resistance to oil and chemicals
- Bright color coding allows for easy brake line identification
- Stainless steel wear plates are resistant to corrosion and improve service life
- Meets SAE J318 requirements
- 1/2" FPT port

| Part # | Description                                           |
|--------|-------------------------------------------------------|
| 035169 | Powder coated service gladhand w/ polyurethane seal   |
| 035170 | Powder coated emergency gladhand w/ polyurethane seal |

### Shutoff Gladhands

- Lightweight die cast aluminum bodies
- Clamp plates are color-coded for easy identification
- Rubber seal included
- Includes mounting seal to prevent corrosion between gladhand and trailer
- Metal inner ball for increased wear ability
- Meets SAE J318 requirements
- 3/8" - 18 port



035152

| Part # | Description       |
|--------|-------------------|
| 035152 | Emergency shutoff |
| 035151 | Service shutoff   |

### 37° Bracket Mount Gladhand



- Lightweight die cast aluminum bodies
- Clamp plates are color-coded for easy identification
- Color-coded polyurethane seal included
- (2) 3/8" FPT ports (one plugged)
- (2) 11/32" diameter mounting holes
- Meets SAE J318 requirements

| Part # | Description        |
|--------|--------------------|
| 035092 | Service gladhand   |
| 035093 | Emergency gladhand |

### Aluminum Gladhands

- Velvac's most economical gladhand
- Clamp plates are color-coded for easy identification
- All include flat rubber coupling seal
- 1/2" FPT port
- Meets SAE J318 requirements



035038



035181



035180

| Part # | Description                                           |
|--------|-------------------------------------------------------|
| 035038 | Universal gladhand                                    |
| 035042 | Emergency gladhand                                    |
| 035045 | Service gladhand                                      |
| 035179 | Aluminum emergency gladhand w/ screen filter          |
| 035180 | Aluminum service gladhand w/ screen filter            |
| 035181 | Aluminum emergency gladhand w/ guardian seal and flap |
| 035182 | Aluminum service gladhand w/ guardian seal and flap   |



Call the Velvac Sales Team: **800.783.8871** sales@velvac.com

### Pivoting Gladhands



- Spring loaded to safely swing out of the way when not in use
- Seals out contaminants when not in use
- 3/8" - 18 NPTF ports

| Part # | Description     |
|--------|-----------------|
| 035167 | Blue - service  |
| 035168 | Red - emergency |

### Polyurethane Gladhand Seals



- Color-coded seals will not crack or tear, reducing maintenance time and cost associated with rubber seal replacement
- Available in attractive display box with 25 sets of seals (set consists of 4 seals per bag, 2 red and 2 blue). See RETAIL section

| Part # | Description              |
|--------|--------------------------|
| 035009 | Red polyurethane seals   |
| 035010 | Blue polyurethane seals  |
| 035011 | Black polyurethane seals |
| 035012 | Display box with seals   |

### "Pacifier" Gladhand Seal

- Reusable gladhand sealing device protects air lines from dust, debris and moisture



| Part # | Description              |
|--------|--------------------------|
| 035142 | "Pacifier" gladhand seal |

### Plated Aluminum Gladhands (with E-Coating)

- E-Coated aluminum gladhand body with a full face plate
- E-Coated aluminum improves corrosion resistance and provides better protection than typical zinc plating
- Service and emergency gladhands have a powder coated face plate for increased corrosion resistance
- Universal gladhand has a zinc plated face plate for increased corrosion resistance
- Rubber seal
- Meets SAE J318 requirements

- Color coded for easy hose identification
- Emergency is polarized to eliminate incorrect hose connections
- Cost saving angle mount eliminates the need for extra mounting hardware



| Part # | Description            | Replaces Haldex-Midland Number | Connection Thread |
|--------|------------------------|--------------------------------|-------------------|
| 035143 | Plated - service       | 11452                          | 1/2" Pipe thread  |
| 035144 | Plated - emergency     | 11451                          | 1/2" Pipe thread  |
| 035145 | Plated - universal     | 11450                          | 1/2" Pipe thread  |
| 035146 | Plated - 37° service   | 11444                          | 1/2" Pipe thread  |
| 035147 | Plated - 37° emergency | 11441                          | 3/8" Pipe thread  |

### Rubber Gladhand Seals



- Seals constructed of durable black Buna N compound
- "Guardian" seal with rubber flap and metal seal screen help protect air lines from debris

| Part # | Description             |
|--------|-------------------------|
| 035005 | Standard seals          |
| 035007 | Flat seals              |
| 035140 | Seal screen             |
| 035141 | Guardian seal with flap |

Guardian™ is a trademark of Velvac, Inc

### Energy Suspension® Seals



- Could be the last seal you buy!
- Designed to fit all SAE approved gladhands
- Polyurethane seals improve resistance to oil and chemicals, increasing service life and decreasing down time
- Will not crack, dry out or tear like the conventional rubber seals
- Rated to -40°F
- 50 seals per bag

| Part # | Description          |
|--------|----------------------|
| 035165 | Blue service seal    |
| 035164 | Red emergency seal   |
| 035166 | Black universal seal |

Energy Suspension® is a registered trademark of Energy Suspension

## GLADHANDS

### Gladhand Seals with Built-in Screens



- Polyurethane seals with stainless steel screens built in
- Traps harmful contaminants before they can cause an air break system failure
- Keeps bugs out of the air lines
- Available in blue, black and red

| Part # | Description                              |
|--------|------------------------------------------|
| 035175 | Blue service seal with screen            |
| 035176 | Red emergency service seal with screen   |
| 035177 | Black universal service seal with screen |

### Stow-A-Way™ Gladhand and Plug Holder



580042

- Holds gladhand and electrical hook ups at a 45° angle for easy insertion and extraction
- When properly placed, allows cable and air line storage with both feet firmly on the ground
- Designed for heavier ABS cables
- Standard mounting holes make it easy to replace older designs
- Glass-filled nylon, non-corrosive construction

| Part # | Description                                   |
|--------|-----------------------------------------------|
| 580042 | Stow-A-Way gladhand & plug holder             |
| 580123 | Stow-A-Way single plug holder & (2) gladhands |

#### Helpful hint:

Improve leverage and reduce air hose kinks by using one of the two styles of gladhand grips

### GladhandL™ Gladhand Grips



035070



035178

- 1/2" NPTF
- Sold in pairs in an attractive display package with information header
- Part No. 035070 polyurethane style features a soft grip with a machined steel core
- Part No. 035178 solid aluminum style features an anodized body with a diamond knurl

| Part # | Description                                                            |
|--------|------------------------------------------------------------------------|
| 035070 | (1) red and (1) blue polyurethane GladhandL™ grip with hardware        |
| 035178 | (1) red and (1) blue solid aluminum gladhand grip, hardware not needed |

### Gladhand Holder Kit



- Designed to mount on all Velvac pogo sticks
- Holds and seals gladhands when tractor is disconnected from trailer
- Durable zinc-plated steel construction
- Single gladhand holder can be mounted directly to cab using 5/16" bolt holes
- Kit includes two gladhand holders and mounting hardware

| Part # | Description          |
|--------|----------------------|
| 581006 | Gladhand holder kit  |
| 580009 | Gladhand holder only |

### Dummy Coupling



035036



035100

- Durable zinc-plated steel construction for corrosion resistance
- 6-1/2" Coupling length
- 8-1/2" Chain Length, 18" cable

| Part # | Description               |
|--------|---------------------------|
| 035036 | Vented dummy coupling     |
| 035037 | Non-vented dummy coupling |
| 035100 | Dummy shut-off gladhand   |

### Glad-Lock™



- Rugged polypropylene gladhand lock helps prevent unwanted connections to tractors and trailers
- Universal design for use on many types of aluminum or iron gladhands
- Two keys furnished with each lock

| Part #   | Description                |
|----------|----------------------------|
| 035150   | Glad-Lock w/ matching keys |
| 035150-6 | Glad-Lock w/ random keys   |

### Line Identification Tags

- 22 gauge aluminum construction with bright red enamel lettering
- 7/8" diameter hole



| Part # | Description   |
|--------|---------------|
| 035025 | Emergency tag |
| 035026 | Service tag   |

GladhandL™, Glad-Lock™ and Stow-A-Way™ are trademarks of Velvac, Inc



Call the Velvac Sales Team: **800.783.8871** sales@velvac.com

## AIR BRAKE HOSE AND TUBING

### Air Brake Hose

- Manufactured to a minimum burst pressure of 870 psi
- Conforms to SAE J1402 and DOT -106 standards
- Performs within an operating temperature range of -40° to +200°F



| Part #   | Hose I.D. | Hose O.D. | Coil Length |
|----------|-----------|-----------|-------------|
| 022011   | 3/8"      | 3/4"      | 50'         |
| 022011-7 | 3/8"      | 3/4"      | 250'        |
| 022047   | 1/2"      | 7/8"      | 50'         |
| 022047-7 | 1/2"      | 7/8"      | 250'        |

\*See pages FH8 & FH9 for applicable reusable fittings

### Slider Air Hose Assemblies with Spring Guard



| Part # | Length | Tube O.D. | Tube I.D. |
|--------|--------|-----------|-----------|
| 149119 | 72"    | 3/8"      | 3/8"      |
| 149120 | 96"    | 3/8"      | 3/8"      |
| 149121 | 108"   | 3/8"      | 3/8"      |
| 149122 | 102"   | 3/8"      | 3/8"      |
| 149123 | 120"   | 3/8"      | 3/8"      |
| 149124 | 102"   | 1/2"      | 3/8"      |
| 149125 | 108"   | 1/2"      | 3/8"      |

### Air Brake Hose Assemblies



- Brake hose assemblies meet SAEJ1402 requirements
- Fittings are permanently swaged

| Length (Inches) | 3/8" I.D. Hose 1/4" Ends One End Fixed One End Swivel | 3/8" I.D. Hose 3/8" Ends One End Fixed One End Swivel | 3/8" I.D. Hose 3/8" Ends Both Ends Swivel | 1/2" I.D. Hose 3/8" Ends One End Fixed One End Swivel | 1/2" I.D. Hose 3/8" Ends Both Ends Swivel | 1/2" I.D. Hose 1/2" & 3/8" Ends, One End Fixed-1/2", One End Swivel-3/8" |
|-----------------|-------------------------------------------------------|-------------------------------------------------------|-------------------------------------------|-------------------------------------------------------|-------------------------------------------|--------------------------------------------------------------------------|
| 9               | 147009                                                | -                                                     | -                                         | -                                                     | -                                         | -                                                                        |
| 12              | 147012                                                | -                                                     | -                                         | 148012                                                | -                                         | -                                                                        |
| 16              | 147016                                                | -                                                     | -                                         | 148016                                                | -                                         | -                                                                        |
| 18              | 147018                                                | 146018                                                | 146518                                    | 148018                                                | 148518                                    | 149018                                                                   |
| 20              | 147020                                                | 146020                                                | 146520                                    | 148020                                                | 148520                                    | 149020                                                                   |
| 22              | 147022                                                | 146022                                                | 146522                                    | 148022                                                | 148522                                    | -                                                                        |
| 24              | 147024                                                | 146024                                                | 146524                                    | 148024                                                | 148524                                    | 149024                                                                   |
| 26              | 147026                                                | 146026                                                | 146526                                    | 148026                                                | 148526                                    | 149026                                                                   |
| 28              | 147028                                                | 146028                                                | 146528                                    | 148028                                                | 148528                                    | 149028                                                                   |
| 30              | 147030                                                | 146030                                                | 146530                                    | 148030                                                | 148530                                    | 149030                                                                   |
| 32              | 147032                                                | 146032                                                | 146532                                    | 148032                                                | 148532                                    | 149032                                                                   |
| 34              | 147034                                                | 146034                                                | 146534                                    | 148034                                                | 148534                                    | 149034                                                                   |
| 36              | 147036                                                | 146036                                                | 146536                                    | 148036                                                | 148536                                    | 149036                                                                   |
| 38              | 147038                                                | 146038                                                | 146538                                    | 148038                                                | 148538                                    | -                                                                        |
| 40              | 147040                                                | 146040                                                | 146540                                    | 148040                                                | 148540                                    | -                                                                        |
| 42              | 147042                                                | 146042                                                | 146542                                    | 148042                                                | 148542                                    | 149042                                                                   |
| 44              | 147044                                                | 146044                                                | 146544                                    | 148044                                                | 148544                                    | -                                                                        |
| 46              | 147046                                                | 146046                                                | 146546                                    | 148046                                                | 148546                                    | 149046                                                                   |
| 48              | 147048                                                | 146048                                                | 146548                                    | 148048                                                | 148548                                    | 149048                                                                   |
| 52              | -                                                     | 146052                                                | -                                         | -                                                     | -                                         | -                                                                        |
| 54              | 147054                                                | 146054                                                | 146554                                    | 148054                                                | 148554                                    | -                                                                        |
| 60              | 147060                                                | 146060                                                | 146560                                    | 148060                                                | 148560                                    | 149060                                                                   |
| 66              | -                                                     | -                                                     | -                                         | 148066                                                | -                                         | -                                                                        |
| 72              | 147072                                                | 146072                                                | 146572                                    | 148072                                                | 148572                                    | 149072                                                                   |
| 84              | -                                                     | 146084                                                | 146584                                    | 148084                                                | 148584                                    | -                                                                        |
| 96              | -                                                     | -                                                     | 146596                                    | 148096                                                | 148596                                    | -                                                                        |

## AIR BRAKE HOSE AND TUBING

### Air Compressor Discharge Hose



- Stainless steel braided outer jacket
- Extruded inner Teflon® tube prevents carbon buildup
- Withstands extreme temperatures of -100° to +450°F

- Hose and reusable fittings can be assembled to produce air compressor discharge hose assemblies

\*See pages FH10 & FH11 for applicable reusable fittings

| Part #   | I.D. | O.D. | Coil Length | Recommended Working Pressure (psi) | Minimum Bursting Pressure (psi) | Minimum Bend Radius |
|----------|------|------|-------------|------------------------------------|---------------------------------|---------------------|
| 142113   | 1/2" | 5/8" | 25'         | 1500                               | 8500                            | 6-1/2"              |
| 142113-7 | 1/2" | 5/8" | 100'        | 1500                               | 8500                            | 6-1/2"              |
| 142114   | 5/8" | 3/4" | 25'         | 1200                               | 6000                            | 7-3/4"              |

### Air Compressor Discharge Hose Assemblies



- 5/8" straight tube x 5/8" compression fitting
- Hose measures 5/8" O.D., 1/2" I.D.

| Part # | Length |
|--------|--------|
| 142118 | 18"    |
| 142124 | 24"    |
| 142130 | 30"    |
| 142136 | 36"    |
| 142148 | 48"    |



- 3/4" straight tube both ends
- Hose measures 3/4" O.D., 5/8" I.D.

| Part # | Length |
|--------|--------|
| 142436 | 36"    |



- 5/8" straight tube both ends
- Hose measures 5/8" O.D., 1/2" I.D.

| Part # | Length |
|--------|--------|
| 142324 | 24"    |
| 142336 | 36"    |

### Rubber Air Line Hose

- Tractor to trailer air line hose assembly
- Hose measures 3/8" O.D., 1/2" I.D.



- Female swivel both ends
- Hose measures 5/8" O.D., 1/2" I.D.

| Part # | Length |
|--------|--------|
| 142518 | 18"    |
| 142524 | 24"    |
| 142536 | 36"    |
| 142552 | 52"    |
| 142554 | 54"    |
| 142572 | 72"    |
| 142584 | 84"    |



- 5/8" compression fitting both ends
- Hose measures 5/8" O.D. 1/2" I.D.

| Part # | Length |
|--------|--------|
| 142618 | 18"    |
| 142624 | 24"    |

| Part # | Description |
|--------|-------------|
| 140139 | 10' Black   |
| 140140 | 12' Black   |
| 140141 | 15' Black   |
| 140142 | 20' Black   |
| 140133 | 12' Blue    |
| 140135 | 15' Blue    |
| 140134 | 12' Red     |
| 140136 | 15' Red     |

Teflon® is a registered trademark of E.I. DuPont de Nemours and Co.



Call the Velvac Sales Team: **800.783.8871** sales@velvac.com



## AIR BRAKE HOSE AND TUBING

### Air Brake Hose Repair Fitting

- Kit for easy repair of 3/8" rubber air brake hose
- One package contains two fittings and one hex installation tool, all in a clamshell for retail display

- One package will repair two 3/8" rubber air brake hoses
- Male fittings feature pre-applied sealant
- Meets DOT 106 SAE J1402 requirements



### Trailer Nose Box Hose Assembly



- Fits conventional and recessed trailer nose boxes
- Manufactured with 3/8" I.D., SAE Type A four spiral air brake hose
- 1-1/2" swaged end fitting, 1-1/2" reusable end fitting with spring
- 5-3/4" length
- Assembly meets SAE J1402 and FMVSS 106 requirements

| Part # | Fitting Size | Sloan # | Tectran # | Tramec # |
|--------|--------------|---------|-----------|----------|
| 500007 | 3/8"         | 431402  | 70-31402  | 31402    |
| 500008 | 1/2"         | 431403  | 70-31403  | 31403    |

### Nylon Tubing

- SAE Type A tubing is single wall extruded non-reinforced nylon
- SAE Type B tubing has seamless extruded nylon core with fiber reinforced protective nylon cover
- Can be used with either air brake or nylon tube fittings
- 150 psi maximum working pressure
- Withstands temperatures of -40° to +200°F
- Tubing meets SAE J844 and FMVSS 106 requirements



**For air brake systems only,  
NOT for fuel line applications**

| Part # | Description                    |
|--------|--------------------------------|
| 140079 | Trailer nose box hose assembly |

NOTE: Replacement fitting assembly with spring available - see Part No. 500019 on page FH9

NOTE See pages FH2-FH9 for applicable fittings  
\*Does not meet DOT or SAE specifications

| Black Part # | Blue Part # | Green Part # | Red Part # | Yellow Part # | Tube O.D. | SAE Type | Coil Length |
|--------------|-------------|--------------|------------|---------------|-----------|----------|-------------|
| 020062       | 020132      | 020142       | -          | -             | 1/8"      | A        | 100'        |
| 020062-7     | -           | -            | -          | -             | 1/8"      | A        | 1000'       |
| 020065       | -           | -            | -          | -             | 5/32"     | A        | 100'        |
| 020066       | -           | -            | -          | -             | 3/16"     | A        | 100'        |
| 020064       | 020134      | 020144       | 020154     | 020164        | 1/4"      | A        | 100'        |
| 020064-6     | 020134-6    | 020144-6     | 020154-6   | 020164-6      | 1/4"      | A        | 1000'       |
| 020052*      | -           | -            | -          | -             | 5/16"     | A        | 100'        |
| 020053       | 020136      | 020146       | 020156     | 020166        | 3/8"      | B        | 100'        |
| 020053-7     | 020136-7    | 020146-7     | 020156-7   | 020166-7      | 3/8"      | B        | 500'        |
| 020055       | 020138      | -            | 020158     | 020168        | 1/2"      | B        | 100'        |
| 020055-7     | 020138-7    | -            | 020158-7   | 020168-7      | 1/2"      | B        | 500'        |
| 020057       | -           | 020157       | -          | -             | 5/8"      | B        | 100'        |
| 020057-7     | -           | -            | -          | -             | 5/8"      | B        | 250'        |
| 020059       | -           | -            | -          | -             | 3/4"      | B        | 100'        |
| 020059-7     | -           | -            | -          | -             | 3/4"      | B        | 250'        |

## AIR BRAKE HOSE AND TUBING

### Fifth Wheel Slider Coil



- Continuously returns to original shape
- Flexes from 10" to 54"
- Includes (2) 1/4" tube 1/4" MPT fittings
- Temp range from -40° to 208°F
- Max. pressure rating of 150 psi
- Meets SAE J844 requirements

| Part # | Description             |
|--------|-------------------------|
| 022028 | Fifth wheel slider coil |

### Cab Blower Kit

- Designed for truck cab or low pressure shop use
- Air hose rated at 200 psi max recommended operating pressure
- Kit includes 50' hose, economy air nozzle, tire inflator and gladhand



| Part # | Description             |
|--------|-------------------------|
| 149001 | Cab blower kit - rubber |
| 149002 | Air blow gun            |



### Air Cab Blow Gun Kit

Kit includes:

- Pre-installed DOT nylon tube fittings
- SAE J844 coiled nylon tube that extends from 10" to 54"
- Two nozzle fittings and lever-type air gun



| Part # | Description          |
|--------|----------------------|
| 149126 | Air cab blow gun kit |

### Tube Cutter

| Part # | Description       |
|--------|-------------------|
| 090028 | Nylon tube cutter |

## 3-IN-1 AIR/ELECTRICAL ASSEMBLIES



| Part # | Length |
|--------|--------|
| 145110 | 10'    |
| 145112 | 12'    |
| 145115 | 15'    |
| 145120 | 20'    |

- Contains a service air line, emergency air line and an ABS power line (green)
- Enclosed in a heavy duty, beveled edge, spiral wrap
- The spiral wrap keeps the unit neat and compact and provides protective covering
- Air hose assemblies conforms to SAE J1402 / FMVSS 107
- ABS cable assembly conforms to SAE J2394 and the 7-way plug to SAE J560

## 4-IN-1 AIR/ELECTRICAL ASSEMBLIES



| Part # | Length |
|--------|--------|
| 145212 | 12'    |
| 145215 | 15'    |

- Contains a service air line, emergency air line, ABS power line (green) and ISO power line (yellow)
- Air hose assemblies conforms to SAE J1402 / FMVSS 107
- ABS cable assembly conforms to SAE J2394 and the 7-way plugs to SAE J560 and ISO 3731, respectively



Call the Velvac Sales Team: **800.783.8871** [sales@velvac.com](mailto:sales@velvac.com)

## COILED NYLON TUBING

### Coiled Nylon Tubing Assembly Kits

- Assemblies include permanently swaged 1/2" - 14 NPTF end fittings with heavy gauge spring for extra support



12' Assembly kit

- Each standard kit contains one emergency (red) and one service (blue) 1/2" O.D. nylon tubing assembly



15' and 20' Assembly kit

- Assemblies meet SAE J844 and FMVSS 106 requirements



15' Assembly kit with long lead

- 6" lead on both ends

| Part # | Description    |
|--------|----------------|
| 022002 | Standard kit   |
| 022004 | Emergency only |
| 022009 | Service only   |

- 12" lead on both ends

| Part # | Length | Description    |
|--------|--------|----------------|
| 022025 | 15'    | Standard kit   |
| 022026 | 15'    | Emergency only |
| 022027 | 15'    | Service only   |
| 022030 | 20'    | Standard kit   |
| 022031 | 20'    | Emergency only |
| 022032 | 20'    | Service only   |

- One 40" lead, one 12" lead

| Part # | Description    |
|--------|----------------|
| 022001 | Standard kit   |
| 022005 | Emergency only |
| 022008 | Service only   |



## GLACIER AIR LINES

### Glacier Air Coils

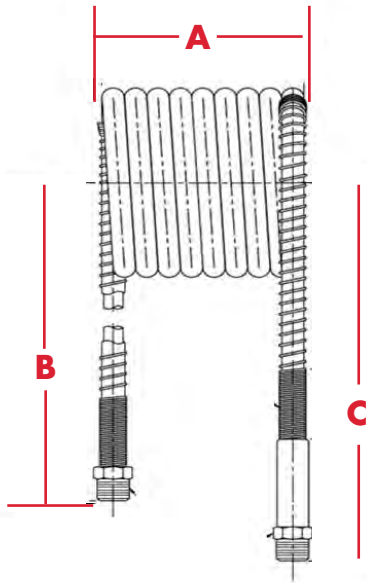

- Larger 5.5" coil O.D. prevents kinking and provides superior recoil and coil memory
- Meets or exceeds applicable requirements of SAE J844, J1131 and FMVSS 571.106
- Durable heavy duty jacketing means coils remain flexible at -85°F (-65°C)
- Permanently swaged 1/2-14 NPTF end fittings with thread sealer simplifies assembly
- 2.5" integrated brass handle allows for easier coupling and uncoupling of gladhands

| Part # | Description      | Working Length - A | Leg Length - B | Leg Length - C |
|--------|------------------|--------------------|----------------|----------------|
| 022633 | Glacier coil set |                    |                |                |
| 022634 | Red              | 12'                | 9.25"          | 11.5"          |
| 022635 | Blue             |                    |                |                |
| 022636 | Glacier coil set |                    |                |                |
| 022637 | Red              | 15'                | 9.25"          | 11.5"          |
| 022638 | Blue             |                    |                |                |
| 022639 | Glacier coil set |                    |                |                |
| 022640 | Red              | 15' Long lead      | 41.25"         | 11.5"          |
| 022641 | Blue             |                    |                |                |
| 022642 | Glacier coil set |                    |                |                |
| 022643 | Red              | 20'                | 9.25"          | 11.5"          |
| 022644 | Blue             |                    |                |                |



Call the Velvac Sales Team: **800.783.8871** [sales@velvac.com](mailto:sales@velvac.com)

## AIR BRAKE VALVES

### Dash Control Valves (PP-1, PP-2, PP-3, PP-7, and PP-8 Styles)



034015  
(as shown; top portion only is different)

- PP-1 Style
- Automatic pressure release at 40 psi
- 1/8" NPT supply port
- Knob and mounting nut sold separately (see page A12)

- Direct replacement for Bendix 275250, 276462
- PP-2 Style
- Automatic pressure release at 40 psi
- 1/8" NPT supply port
- (2) 1/8" NPT delivery ports
- 1/8" NPT brake valve port
- Knob and mounting nut sold separately (see page A12)



034017



034018

- PP-3 Style
- Tripper exhausts at 30 psi and charges above 50 psi
- Plunger trips at 40 psi and charges manually
- 1/8" NPT supply port
- 1/4" NPT delivery port
- 1/4" NPT exhaust port
- Knob and mounting nut sold separately (see page A12)

| Part #  | Delivery Ports | Replaces                                        |
|---------|----------------|-------------------------------------------------|
| 034013  | (2) 1/8" NPT   | Bendix 275175, 276566, 276567 & Midland KN20021 |
| 034015* | (2) 1/8" NPT   | Bendix 279786, 281587                           |
| 034014  | (2) 1/4" NPT   | Bendix 287417, 287600                           |

| Part # | Description                          |
|--------|--------------------------------------|
| 034016 | Pressure balanced dash control valve |



034080  
(as shown; top portion only is different)

- PP-7 style
- Automatic pressure release at 40 psi
- Non-override at 25 psi
- 1/8" NPT supply and control ports
- 1/4" NPT delivery port
- 1/4" threaded exhaust port on Part No. 034079
- Knob and mounting nut sold separately (see page A12)

| Part #  | Description                          | Replaces      |
|---------|--------------------------------------|---------------|
| 034017  | Automatic tripper dash control valve | Bendix 288746 |
| 034018* | Automatic tripper dash control valve | Bendix 279787 |

\*Remote controlled - 1/4" - 20 female thread for knob or cable

\*Remote controlled - 1/4" - 20 female thread for knob or cable



- Direct replacement for Bendix 287238 & Midland KN20035
- PP-8 style
- Automatic pressure release at 20 psi
- 1/8" NPT supply, delivery (2) and exhaust ports

| Part # | Description        |
|--------|--------------------|
| 034019 | Dash control valve |

| Part #  | Shaft Diameter | Replaces                                |
|---------|----------------|-----------------------------------------|
| 034051  | 3/8"           | Bendix 288239, 288721 & Midland KN20025 |
| 034079  | 5/16"          | Bendix 106113, 288241                   |
| 034080* | 1/2"           | Bendix 288242                           |

\*Remote controlled - 1/4" - 20 female thread for knob or cable

### Push-Pull Dash Control Valve



- Direct replacement for Midland KN20030, KN20031
- Automatic pressure release at 25-35 psi
- All ports 1/4" NPT
- 1/4" - 28 thread size

| Part # | Description        |
|--------|--------------------|
| 034055 | Dash control valve |

## AIR BRAKE VALVES

### Pressure Reducing Valve (RV-1 Style)

- Direct replacement for Bendix 283590
- Used where a constant set pressure lower than supply pressure is required
- Adjustable-factory preset at 70 psi
- 1/4"-18 NPT supply and delivery ports



| Part # | Description             |
|--------|-------------------------|
| 034085 | Pressure reducing valve |

### Tractor Protection Valve (TP-3 Style)

- Direct replacement for Bendix 279000 & Midland KN34060
- 1/4" NPT tractor emergency port
- 3/8" NPT tractor service port
- 1/2" NPT trailer emergency and trailer service ports



| Part # | Description              |
|--------|--------------------------|
| 034068 | Tractor protection valve |

NOTE: Always use this valve in conjunction with a PP-1, PP-3 or PP-7 style dash control valve (see page A11)

### Knob and Pin Kits



034049



034054



034053



034050



034052

| Part # | Description                                                                                                   | Replaces                        |
|--------|---------------------------------------------------------------------------------------------------------------|---------------------------------|
| 034049 | Trailer air supply knob and pin kit for PP-7 style dash control valve                                         | Bendix 290655 & Midland KN20900 |
| 034050 | Parking brake knob and pin kit for PP-1 style dash control valves                                             | Bendix 248433 & Midland KN20903 |
| 034052 | Plain black knob and pin                                                                                      | Bendix 241866                   |
| 034053 | Pull to Park/ Push to release parking brake knob and pin kit for PP-1, PP-2 and PP-3 style dash control valve | Bendix 240302                   |
| 034054 | Dash control valve mounting nut                                                                               | Bendix 239357                   |

NOTE: All knob kits include roll pin for securing valve

### Tractor Protection Valve (TP-5 Style)

- Direct replacement for Bendix 288605
- Formerly VM-2 style control valve manifold
- 3/8" NPT service and trailer / emergency supply ports (rear)
- 1/4" NPT stop light switch port
- 3/8" NPT trailer control port
- 1/2" NPT trailer service and trailer emergency supply ports



| Part # | Description              |
|--------|--------------------------|
| 034082 | Tractor protection valve |

### Dash Control Valve (MV-3 Style)

- Direct replacement for Bendix 065157, 800516
- Combination PP-1 and PP-7 valve
- 1/4" diameter horizontal mounting holes at 4-7/32" O.C.
- 1/4" diameter vertical mounting at 3" O.C. mounting holes



| Part # | Description                                                                |
|--------|----------------------------------------------------------------------------|
| 034081 | Dash control valve                                                         |
| 034148 | Trailer air supply and parking brake knob and pin kit for MV-3 style valve |



034148



Call the Velvac Sales Team: **800.783.8871** sales@velvac.com

## AIR BRAKE VALVES

### Modulating Relay Valve (R-7 Style)

- Direct replacement for Bendix 103081, 283932
- 3/8" NPT supply and (2) delivery ports
- 1/4" NPT control and balance ports
- Spring brake release pressure of 95 psi



| Part # | Description            |
|--------|------------------------|
| 034023 | Modulating relay valve |

### Double Check Valve (DC-4 Style)

- Direct replacement for Bendix 278614 & Midland KN25060
- All ports 3/8" NPT
- May be mounted in any position



| Part # | Description        |
|--------|--------------------|
| 034062 | Double check valve |

### Relay Valve

- Direct replacement for Midland KN28060
- 3/8" NPT control port
- (2) 1/2" NPT supply (reservoir) ports
- Crack pressure 4.6 psi
- (2) 3/8" delivery ports



| Part # | Description |
|--------|-------------|
| 034059 | Relay valve |

**NOTE: Part numbers listed in RED are NEW!**

### Relay Valves (R-6 Style)

- 1/4" NPT service port
- (4) 3/8" NPT delivery ports



| Part # | Supply Port(s)                                 | Replaces              |
|--------|------------------------------------------------|-----------------------|
| 034020 | (1) 1/2" NPT                                   | Bendix 279180, 280375 |
| 034021 | (1) 3/4" NPT (in mounting flange) (1) 3/8" NPT | Bendix 279952         |

### Relay Valve (R-8 Style)

- Direct replacement for Bendix 286370, 286371
- 1/4" NPT service port
- (2) 3/4" NPT supply ports
- (2) 1/2" NPT, (1) 1/4" NPT delivery ports
- 1/8" NPT balance port located under exhaust cover
- Cracking pressure 3 psi



| Part # | Description |
|--------|-------------|
| 034024 | Relay valve |

### Relay Valves (R-12 and R-14 Styles)



R-12 Style



R-14 Style 1/2" NPT



R-14 1/8" NPT balance port located under exhaust cover

| Part # | Style | Supply Port(s) | Delivery Ports          | Replaces              |
|--------|-------|----------------|-------------------------|-----------------------|
| 034025 | R-12  | 1/2" NPT       | Verticle (4) 1/2" NPT   | Bendix 102166, 102626 |
| 034026 | R-12  | (2) 3/4" NPT   | Horizontal (2) 1/2" NPT | Bendix 103009         |
| 034027 | R-14  | (2) 3/4" NPT   | Horizontal (2) 1/2" NPT | Bendix 103010         |
| 034028 | R-14  | 1/2" NPT       | Verticle (4) 1/2" NPT   | Bendix 103028         |

### Relay Valves (RG-2 Style)

- Fast, low cracking pressure - 5 psi
- 1/4" NPT control port



| Part # | Reservoir Ports    | Delivery Ports | Replaces        |
|--------|--------------------|----------------|-----------------|
| 034056 | (2) 3/8"           | (2) 3/8"       | Midland KN28500 |
| 034057 | (1) 3/8", (1) 1/2" | (2) 3/8"       | Midland KN28510 |
| 034058 | (2) 1/2"           | (2) 1/2"       | Midland KN28520 |

## AIR BRAKE VALVES

### Relay Emergency Valve (RE-6 Style)

- Direct replacement for Bendix 281865
- 1/4" NPT service and emergency ports
- (1) 3/4" NPT, (1) 3/8" NPT supply ports
- (2) 3/8" NPT, (2) 1/4" NPT delivery ports



| Part # | Description     |
|--------|-----------------|
| 034029 | Relay emergency |

### Multi-Function Trailer (RT-4 Style)

- Direct replacement for Midland KN26000
- 3/8" NPT trailer supply and control ports
- 1/2" NPT and 3/8" NPT reservoir ports
- (4) 3/8" NPT delivery ports
- PPV closing pressure at 55 psi



| Part # | Description                  |
|--------|------------------------------|
| 034063 | Multi-function trailer valve |

### Relay Emergency Valves



034066

- 1/4" NPT delivery and service control ports
- 1/2" NPT supply port



034067

- 1/4" NPT service and emergency inlets
- (4) 3/8" NPT delivery ports
- 3/4" NPT reservoir
- Crack pressure 3 psi



034069  
(w/ratio feature)

- 1/4" NPT emergency and service ports
- (4) 3/8" NPT delivery ports
- 3/4" NPT reservoir port

| Part # | Description           | Replaces                        |
|--------|-----------------------|---------------------------------|
| 034066 | Relay emergency valve | Sealco A-1000                   |
| 034067 | Relay emergency valve | Midland KN30400 & Wagner A99036 |
| 034069 | Relay emergency valve | Sealco 110200                   |

### Air Governors (D-2 Style)

- Factory preset opening and closing pressures of 100 to 120 psi
- (6) 1/8" NPT ports and two mounting holes
- Mounting gasket and (4) 1/8" socket head pipe plugs included
- High temperature governor designed with high temperature withstanding O-rings
- Individually boxed



| Part # | Description                   | Replaces                        |
|--------|-------------------------------|---------------------------------|
| 032131 | Air governor                  | Bendix 275491 & Midland KN18530 |
| 034083 | High temperature air governor | Bendix 284358 & Midland KN18534 |



Call the Velvac Sales Team: **800.783.8871** [sales@velvac.com](mailto:sales@velvac.com)



## AIR BRAKE VALVES

### Foot Valves (E-3, E-6, and E-7 Styles)

- Direct replacement for Bendix 277863 & Midland KN22100
- E-3 style
- 1/2" NPT supply and delivery ports
- (2) 1/4" NPT auxiliary supply ports



- Direct replacement for Bendix 286171 & Midland KN22140 and KN22150
- E-6 style
- 3/8" NPT supply and delivery ports



### Spring Brake Valve (SR-1 Style)

- Direct replacement for Bendix 286364
- 1/4" NPT reservoir, control, supply and delivery ports
- 55 psi reservoir trip pressure
- Bracket mounted



| Part # | Description                |
|--------|----------------------------|
| 034038 | Single circuit brake valve |

| Part # | Description              |
|--------|--------------------------|
| 034039 | Dual circuit brake valve |

| Part # | Description        |
|--------|--------------------|
| 034030 | Spring brake valve |



034040



034077

- E-7 Style
- Dual circuit valves
- 1/2" exhaust port with diaphragm
- Three mounting holes - firewall mounted
- O-rings included

### Trailer Spring Brake (SR-5 Style)

- Direct replacement for Bendix 065437
- 3/4" NPT reservoir mounting port
- 1/4" NPT service/spring brake reservoir, service, trailer supply and trailer service ports
- (4) 3/8" NPT delivery ports
- Anti-compounding



| Part # | Side Ports                                      | Rear Ports                                          | Application | Replaces      |
|--------|-------------------------------------------------|-----------------------------------------------------|-------------|---------------|
| 034040 | (2) 1/4" Supply                                 | No threads                                          | Ford        | Bendix 284760 |
| 034077 | (4) 1/4" Supply<br>(4) 1/4" Delivery (Threaded) | 1/8" Supply<br>(2) 1/2" Supply<br>(2) 1/2" Delivery | Navistar    | Bendix 288383 |

### Trailer Spring Brake Valves (SR-2 and SR-4 Styles)



034031



034032



- SR-2 style valves
- 1/4" NPT service reservoir (2) and trailer supply ports
- (4) 3/8" NPT delivery ports
- 1/4" NPT trailer service port on Part No. 034031

- SR-4 style valves
- 1/4" NPT reservoir charging (2), trailer supply and trailer serviceports
- (4) 3/8" NPT delivery ports

| Part #  | Reservoir Port | Replaces      |
|---------|----------------|---------------|
| 034031  | 1/2" MPT       | Bendix 103061 |
| 034032* | 3/4" MPT       | Bendix 287376 |

| Part # | Reservoir Port | Replaces      |
|--------|----------------|---------------|
| 034033 | 3/4" MPT       | Bendix 101112 |
| 034034 | 1/2" MPT       | Bendix 101622 |

| Part # | Description                |
|--------|----------------------------|
| 034035 | Trailer spring brake valve |

\*Does NOT have trailer service port for anti-compound

## AIR BRAKE VALVES

### In-Line Quick Release Valves



032019



032020

- Speeds up release of trailer service brakes when installed on service side gladhand
- Speeds up application of trailer parking brakes when installed on emergency side gladhand
- Suitable for use on double or triple trailers
- Durable zinc die cast bodies
- Flow Rate: Forward - 9.0 SCFM at 2 psi; Exhaust - 8.0 SCFM at 2 psi
- 1/2" - 14 MPT with Vibraseal thread sealer one end, 1/2" - 14 FPT other end
- 1-1/2" diameter x 3-1/2" long

| Part # | Description                                           |
|--------|-------------------------------------------------------|
| 032019 | Mounts between tractor protection valve and air lines |
| 032020 | Mounts at tractor gladhand                            |

### Quick Release / Double Check Valve (QR-1C Style)



- Direct replacement for Bendix 289714 & Midland KN32041
- 1/4" NPT supply and balance ports
- (2) 3/8" NPT delivery ports
- (2) 1 1/32" diameter mounting holes at 1-1/2" on center
- Supply and delivery differential is 1 psi max

| Part # | Description         |
|--------|---------------------|
| 034012 | Quick release valve |

### Quick Release Valves (QR-1 Style)

- 3/8" NPT exhaust port
- (2) 1 1/32" mounting holes at 1-1/2" on center
- Cracking pressure of 1 psi



| Part # | Delivery Ports | Supply Ports | Replaces                                |
|--------|----------------|--------------|-----------------------------------------|
| 032015 | 3/8" NPT       | 3/8" NPT     | Bendix 229859, 288251 & Midland KN32005 |
| 032018 | 3/8" NPT       | 1/2" NPT     | Bendix 229860 & Midland KN32011         |
| 034078 | 1/4" NPT       | 3/8" NPT     | Bendix 229813                           |

### Limiting and Quick Release Valves (LQ-2 and LQ-4 Styles)

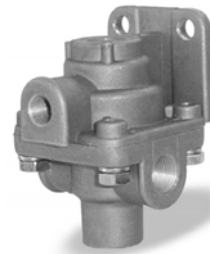

- Direct replacement for Bendix 229505
- LQ-2 style
- Limits front axle service brake application by 50% and serves as a quick release valve for that axle - commonly found on pre-121 (pre-1985) vehicles
- 3/8" NPT supply, delivery and exhaust ports
- 1/4" NPT control port
- 19/32" diameter mounting holes at 1-1/2" on center

| Part # | Description                      |
|--------|----------------------------------|
| 034084 | Limiting and quick release valve |

- Direct replacement for Bendix 289144
- LQ-4 style
- For limiting front axle pressure
- 3/8" NPT supply and delivery ports
- (2) 19/32" diameter mounting holes at 1-1/2" on center
- Nominal hold off pressure of 4 psi
- Nominal equalizing pressure of 60 psi



| Part # | Description                      |
|--------|----------------------------------|
| 034036 | Limiting and quick release valve |



Call the Velvac Sales Team: **800.783.8871** sales@velvac.com

## AIR BRAKE VALVES

### Air Tractor Control Kits

- Kits add hand and foot control to trucks with pre-FMVSS 121 air brakes hauling an air brake trailer (for trucks with FMVSS 121 air brakes, consult the truck manufacturer)
- Hose assembly jumper lines and support springs included with kit (kit No. 131012 only)
- Hand control valve included (except for Part No. 131016). This normally closed valve has 1/4" FPT inlet/ outlet/exhaust ports and an 1/8" FPT pressure gauge port

(180 psi maximum supply pressure)  
- hand control valve also sold separately

- NOT FOR ABS APPLICATIONS



131012

| Part # | Description                                         |
|--------|-----------------------------------------------------|
| 131012 | Kit for tractor installations                       |
| 131014 | Kit for dump truck installations                    |
| 131016 | Kit for dump truck installations without hand valve |
| 032051 | Hand control valve                                  |

## AIR ACCESSORY VALVES

### Universal Fan Clutch Drive Solenoid Kit



Five year guarantee against failure under normal operating conditions!

- Nominal voltages: 12 VDC
- Working voltage: 11-16 VDC
- Maximum operating pressure: 150 psi
- Max exposure temperature: 200°F
- Mounting hole: 3/8"
- Ports: (3) 1/8" - 27 FPT
- Universal kit replaces existing solenoids found on Kysor, Bendix and Horton fan clutches
- Kit includes valve, wire harness with Weather-Pack sealed connectors, exhaust shield, in-line filter and butt connectors

| Part #  | Description                       |
|---------|-----------------------------------|
| 032192  | Universal solenoid kit            |
| 032194* | Replacement solenoid              |
| 032190  | Replacement in-line filter        |
| 032191  | Replacement 1/8" NPT exhaust vent |

\*Valve may also be used for shutter stat solenoid applications. Replaces Navistar numbers 450284C91 and 1692761C91 for this use

### Three-Way Solenoid

- Provides On/Off exhaust function
- Inlet port normally closed - for intermittent use only
- (2) 1/4" FPT ports
- 12 VDC
- 100 - 120 psi operating pressure
- 2-9/32" diameter mounting holes on 2-1/2" centers



| Part # | Description        |
|--------|--------------------|
| 320051 | Three-way solenoid |

### Air Solenoid Valve

- Direct replacement for Neway 90054075 (normally open)
- 12 VDC, 10 watts
- Intermittent use only
- 100psi maximum operating pressure
- 1/4" threads



| Part # | Description        |
|--------|--------------------|
| 034075 | Air solenoid valve |

NOTE: Always use in conjunction with a momentary contact switch (see Part No. 090202 on page E14)

## AIR ACCESSORY VALVES

### Power Take-off and Dump Pump Control Valve Kit



- Replaces Chelsea 328388-79X
- Kit includes combo control valve with 1/4" built-in push-to-connect fittings, in-line fuse holder with 9 amp fuse, cable, pressure protection valve 1/4" nylon tubing (50') and fittings-control valve assembly also sold separately

| Part # | Description                            |
|--------|----------------------------------------|
| 032144 | PTO and dump pump control valve kit    |
| 032142 | Combo control valve (feathering valve) |
| 034073 | PTO cable                              |
| 032086 | Pressure protection valve              |

### Power Take-Off Air Shift Kit



- Power take-off kit controls add-on air-controlled accessories
- Kit includes control valve, indicator light, 1/4" nylon tubing (50') and fittings, cable, bracket and pressure protection valve. Control valve assembly, indicator light and cable sold separately

| Part # | Description                  |
|--------|------------------------------|
| 034070 | Power take-off air shift kit |
| 034071 | Air shift valve assembly     |
| 034072 | Indicator light              |
| 034073 | PTO cable                    |
| 032086 | Pressure protection valve    |

### Power Take-Off Four-Way Control Valve



- Replaces Chelsea 328865X
- Panel-mounted, three position valve
- 1/8" - 27 NPTF
- 150 psi maximum operating pressure
- Operating temperature range from -20° to +200°F

| Part # | Description                         |
|--------|-------------------------------------|
| 032145 | PTO four-way control valve assembly |

### Power Take-Off Combo Control Valve with Shift Tower

- Combo valve controls PTO and dump pump operations
- 1/4" brass push-to-connect fittings included on valve assembly
- Shift tower measures 4-5/8" x 3-5/8" x 8" H overall with 2" access hole and mounting holes 4-1/4" on center



| Part # | Description                            | Replaces        |
|--------|----------------------------------------|-----------------|
| 032143 | PTO combo valve with shift tower       | -               |
| 032142 | Combo control valve (feathering valve) | Chelsea 329358X |
| 032146 | Control valve shift tower              | Chelsea 329219X |



Call the Velvac Sales Team: **800.783.8871** sales@velvac.com

## AIR ACCESSORY VALVES

### In-Line Quick Release Valves

- Push-connect fittings mate easily with 1/4" nylon tubing for easy installation
- 150 psi maximum operating pressure
- On/Off faceplate Part No. 032039 fits air-electric and flipper valves Part Nos. 032232, 032233, 032234 and 032236 and installs using 10-24 x 1/4" screw
- Air-Electric Valves  
Technical Information:
  - » Switch Off Position: No air flow, electrical contacts open
  - » Switch On Position: Air flows through valve, electrical contacts closed
  - » Amperage: 5 amp resistive current load at 12 VDC
  - » Terminal Size: 1/4" blade
  - » Pressure Switch: Open below 10 psi, closed above 35 psi



| Part # | Photo | Description                | Toggle Style | Lever Position | Primary Vehicle Application |
|--------|-------|----------------------------|--------------|----------------|-----------------------------|
| 032225 | A     | Air-electric toggle valve  | Paddle       | -              | Kenworth, Volvo             |
| 032227 | B     | Air-electric toggle valve  | Blade        | -              | Mack                        |
| 032228 | C     | Air-electric toggle valve  | Bat          | -              | Peterbilt                   |
| 032229 | D     | Air toggle valve           | Paddle       | -              | Kenworth, Volvo             |
| 032231 | E     | Air toggle valve           | Blade        | -              | Mack                        |
| 032232 | F     | Air-electric flipper valve | -            | Right off      | Freightliner                |
| 032234 | F     | Air-electric flipper valve | -            | Right off      | Navistar                    |
| 032235 | F     | Air-electric flipper valve | -            | Right off      | Navistar                    |
| 032233 | G     | Air flipper valve          | -            | Right off      | Freightliner                |
| 032236 | G     | Air flipper valve          | -            | Right off      | Navistar                    |

\*These are only primary listings-valves are universal and suitable for a variety of applications

### Transmission Selectors



| Part # | Description          |
|--------|----------------------|
| 032400 | Trans selector A4487 |
| 032401 | Trans selector A4490 |
| 032402 | Trans selector A4491 |

### Transmission Range



| Part # | Description        |
|--------|--------------------|
| 032403 | Range value A-6909 |
| 032404 | Range value A-6913 |
| 032405 | Range value A-6915 |
| 032406 | Range Value A-6918 |

### Universal Three-Way Toggle Valve



- 1/8" NPT supply and delivery (2) ports
- Includes chrome-plated flip handle
- Faceplate sold separately - install using a 10-24 x 1/4" screw

| Part # | Description                      |
|--------|----------------------------------|
| 032037 | Universal three-way toggle valve |
| 032039 | Faceplate - On/Off               |

## AIR ACCESSORY VALVES

### Universal Air Accessory Dash Valves



- Two position, three-way air valves
- Include DOT compliant (FMVSS 106) push-to-connect fittings for 1/4" tubing
- Built-in standard four pin electrical connector for backlit function
- Additional rear port used to easily jumper air lines between valves
- Fit standard 22 mm x 44 mm openings, easily replacing valves found on many current model trucks
- Operating Temperature: -10° to +160°F
- Rated Pressure: 150 psi maximum
- Rated Current Load: 1 amp at 14 VDC (max.)
- Electric Connector: Valve connector mates with Metri-Pack 150 Series connector Part No. 12045813 with female terminals (for reference only - not available from Velvac and not included)

| Part # | Description                             |
|--------|-----------------------------------------|
| 032247 | Inter-axle differential lock dash valve |
| 032248 | Fifth wheel slide dash valve            |
| 032249 | Air suspension dump dash valve          |
| 032250 | Power take off dash valve               |
| 032253 | Universal dash valve                    |
| 032022 | Inter-axle differential lock dash valve |
| 032023 | Differential lock dash valve            |

### Height Control Valves: Standard Leveling Valve, Cab Leveling Valve and a Rapid Dump Feature Valve

- Valves feature patent Shear-Seal® design technology
- Superior performance in high cycle and contaminated air conditions
- Precision machined metal sealing surface creates a zero leak\* seal
- Increased life expectancy and lower air consumption
- Direct replacement for many OE valve installations

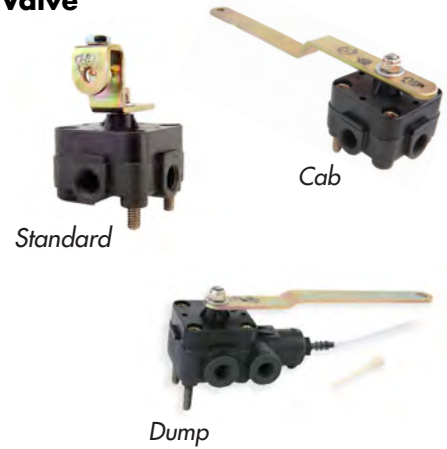

| Part # | Description            | Ports    | Replaces                                                                                     | Used with Vehicles                                     |
|--------|------------------------|----------|----------------------------------------------------------------------------------------------|--------------------------------------------------------|
| 034101 | Cab valve              | 1/4" NPT | WABCO S464 007 004-0<br>Barksdale KD2483                                                     | International cab, Peterbilt cab                       |
| 034111 | Standard chassis valve | 1/4" NPT | WABCO S464 002 443-0<br>Barksdale KD2484<br>Midland KN 27000                                 | International chassis                                  |
| 034112 | Standard chassis valve | 1/4" NPT | Hadley/Neway 90054007,<br>Barksdale KD2485                                                   | Kenworth chassis                                       |
| 034113 | Standard chassis valve | 1/4" NPT | Delco King of the Road 12C-1<br>(KOR 5549705) & 12-6-2<br>(KOR 5549706),<br>Barksdale KD2489 | Volvo chassis                                          |
| 034114 | Standard chassis valve | 1/4" NPT | Hadley H00450CE<br>Barksdale KD2482                                                          | Volvo / Mack chassis                                   |
| 034122 | Dump valve             | 1/4" NPT | Hadley H00500RS<br>Barksdale KD2486                                                          | International chassis                                  |
| 034123 | Dump valve             | 1/4" NPT | WABCO 464 008 115-0<br>Barksdale KD2487                                                      | Volvo chassis                                          |
| 034124 | Dump valve             | 1/4" NPT | International 2506169C91<br>Hadley HAD500NS,<br>Barksdale KD2488                             | International chassis w/dump, Peterbilt chassis w/dump |
| 034126 | Dump valve             | 1/4" NPT | Haldex PR 90554950 &<br>90554945,<br>Barksdale KD2490                                        | Kenworth chassis w/dump, Volvo chassis                 |
| 034137 | Standard chassis valve | 1/4" NPT | Barksdale KD2481, Volvo<br>85112638, Volvo 85108667,<br>Volvo 85112623,<br>Mack 99QK148M     | Volvo / Mack chassis                                   |

NOTE: See photos on next page.  
\*Zero-leak is less than 4CC per minute

Shear-Seal® is a registered trademark of Barksdale Control Products



034137



Call the Velvac Sales Team: **800.783.8871** sales@velvac.com

### Shear-Seal® Height Control Valve



034122



034123



034124



034112



034101



034126



034113



034114



034111

### Shear-Seal® Height Control Valve Linkage and Hardware

#### Adjustable Linkage

- Adjusts for 8-3/4" to 14-1/2"
- 1/4" diameter mounting bolts
- Zinc plated steel rods
- Elastomer ends



Adjustable linkage



034135



034136



034134

| Part # | Description                                            |
|--------|--------------------------------------------------------|
| 034130 | Adjustable Linkage - adjustment range 6.9-9.6 inches   |
| 034131 | Adjustable Linkage - adjustment range 9.8-11.5 inches  |
| 034132 | Adjustable Linkage - adjustment range 10.9-13.6 inches |
| 034133 | Adjustable Linkage - adjustment range 12.8-19.0 inches |
| 034134 | Linkage Hardware - 5/16-18 thread                      |
| 034135 | Linkage Hardware - 1/4-20 thread                       |
| 034136 | Linkage Hardware - 8 mm course thread                  |



## AIR ACCESSORY VALVES

### Height Control Valves



032139



034065  
Delayed response\*\*



034064  
Immediate response

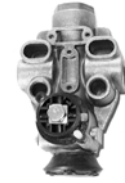

032140



032141  
Immediate response\*

| Part #   | Ports    | Description                   | Replaces                        |
|----------|----------|-------------------------------|---------------------------------|
| 032139   | 1/8" NPT | Includes linkage and brackets | Hadley H600                     |
| 032140   | 1/4" NPT | Valve only                    | Midland/Haldex & Neway 90554241 |
| 032141*  | 1/4" NPT | Includes built-in dump valve  | Midland/Haldex & Neway 90554271 |
| 034064   | 1/4" NPT | Includes linkage kit          | Midland KN27000                 |
| 034065** | 1/8" NPT | Includes fitting package      | Neway 90054007                  |

\* Normally open dump feature; needs air pressure to dump from air spring

\*\*7-12 seconds prior to releasing air to air bags; also known as self-leveling

### Air Horn Actuator Valves

- Direct replacements for air horn valves found on many trucks
- Replace similar valves from both Grover and Hadley
- Molded mounting bracket and push-connect fittings provide easy installation



| Part # | Photo | Description      | Ports              | Vehicle Application |
|--------|-------|------------------|--------------------|---------------------|
| 032240 | A     | Single outlet    | (3) 1/4"           | Kenworth            |
| 032241 | A     | Dual outlet      | (3) 1/4"           | Kenworth            |
| 032242 | B     | Dual outlet      | (3) 1/4", (1) 3/8" | Freightliner        |
| 032243 | B     | Single outlet    | (3) 1/4", (1) 3/8" | Freightliner        |
| 032244 | C     | Medium-duty      | (2) 3/8"           | Navistar            |
| 032245 | D     | Conventional cab | (2) 3/8"           | Navistar            |
| 032246 | E     | Cab over         | (2) 3/8"           | Navistar            |

### Rapid Dump Air Suspension Valve



- Replaces Humphrey 250A N/O valves
- Pilot operated
- Dual delivery design allows for in-line plumbing of air spring lines and eliminates need for tee fittings
- (4) 1/8" FPT ports
- Mounts on either right or left frame rail using 1/4" mounting holes

| Part # | Description                     |
|--------|---------------------------------|
| 032195 | Rapid dump air suspension valve |



Call the Velvac Sales Team: **800.783.8871** sales@velvac.com



## AIR ACCESSORY VALVES

### Pressure Protection Valves

- Nominally closed
- Nominal closing pressure 65-75 psi
- (2) 1/4" FPT ports
- 150 psi maximum operating pressure



- Designed for convenient in-tank mounting on tanks with dual outlet ports
- All valves except Part No. 032221 include Vibraseal sealant on mounting thread for easy installation

| Part # | Description               |
|--------|---------------------------|
| 032086 | Pressure protection valve |

- Direct replacement for Bendix 286500
- 1/4" NPT supply and delivery ports
- 85 psi nominal closing pressure
- Non-adjustable



PR-4 Style

| Part # | Description               |
|--------|---------------------------|
| 034037 | Pressure protection valve |

### Three-Way Pilot Valve

- Direct replacement for Neway 90054079
- For Neway suspension systems
- 1/4" NPT supply / delivery / exhaust ports



| Part # | Description           |
|--------|-----------------------|
| 034074 | Three-way pilot valve |

| Part # | Inlet Port (NPTM) | Outlet Ports (NPTF) | Nominal Opening Pressure (psi) | Nominal Closing Pressure (psi) | Primary Vehicle Application |
|--------|-------------------|---------------------|--------------------------------|--------------------------------|-----------------------------|
| 032216 | 3/8"              | 3/8"                | 55                             | 45                             | Freightliner                |
| 032217 | 3/8"              | 3/8"                | 85                             | 67                             | Ford                        |
| 032218 | 1/2"              | 3/8"                | 55                             | 45                             | Freightliner                |
| 032219 | 1/2"              | 3/8"                | 85                             | 67                             | Freightliner                |
| 032220 | 1/2"              | 1/4"                | 65                             | 55                             | Peterbilt                   |
| 032221 | 1/2"              | 1/4"                | 100 (max)                      | 70 (min)                       | Kenworth                    |
| 032222 | 1/4" Hex nipple   | 1/4"                | 100 (max)                      | 70 (min)                       | Mack*                       |

NOTE These are only primary listings-valves are universal and suitable for a variety of applications

\* Replaces Mack number 20QE2326A

### Height and Lumbar Control Seat Valves



- Valves control air ride truck seats and lumbar supports
- Available in push/pull and paddle type configurations
- Spring-loaded, three-way function

- Electro-pneumatic combination valve designed to operate air seats using an electric air compressor
- Designed to replace valves on seats by major manufacturers such as Bostrom, National and Sears

| Part # | Photo | Description                                                            | Ports           | Primary Seat Application |
|--------|-------|------------------------------------------------------------------------|-----------------|--------------------------|
| 032110 | A     | End and side ported with removable chrome knob                         | (2) 1/8" FPT    | Various                  |
| 032205 | B     | End ported with removable chrome knob                                  | (2) 1/8" FPT    | Various                  |
| 032206 | C     | Electro-pneumatic with removable black knob & (2) 1/4" blade terminals | (1) 1/8" FPT    | Various                  |
| 032201 | D     | Paddle type                                                            | (2) 3/16" Barbs | Bostrom                  |

NOTE These are only primary listings-valves are universal and suitable for a variety of applications

## PRESSURE SWITCHES AND INDICATORS

### Air Pressure Gauge

- 1-1/2" diameter dial
- Accommodates a 1/8" FPT port
- Pressure range of 0 - 160 psi



| Part # | Description        |
|--------|--------------------|
| 035065 | Air pressure gauge |

### Brake Light Switch (SL-4 Style)

- Direct replacement for Bendix 228600
- 1/4" NPT supply
- Actuates at 3-5 psi



| Part # | Description       |
|--------|-------------------|
| 036036 | Stop light switch |

### Low Pressure Indicators (LP-3 Style)

- 1/4" NPT supply
- Automatic pressure release at 60 +/- 6 psi



| Part # | Description     | Replaces      |
|--------|-----------------|---------------|
| 034041 | Single terminal | Bendix 279416 |
| 034042 | Double terminal | Bendix 228750 |

NOTE: Use in conjunction with either warning buzzer Part No. 036043 or warning light Part No. 036049

### Pressure Regulator Valve

- A compact, high quality in-line pressure regulator with gauge and bracket kit, rated to 125 psi with 1/4" NPT ports



| Part # | Description              |
|--------|--------------------------|
| 320149 | Pressure regulator valve |

### Low Air Warning Buzzer

- 12 volt buzzer
- 9/32" diameter mounting holes



| Part # | Description            |
|--------|------------------------|
| 036043 | Low air warning buzzer |

NOTE: Use in conjunction with a low pressure switch, Part No. 034041 or 034042

### Low Air Pressure Warning Light

- 12 volt red light
- Uses #57, 1895 or 293 bulb
- Mounts through 3/4" hole
- Complete with low air face plates



| Part # | Description                             |
|--------|-----------------------------------------|
| 036049 | Low air pressure warning light assembly |
| 002063 | Replacement red pilot light             |
| 036045 | Replacement faceplate                   |

NOTE: Use in conjunction with a low pressure switch Part Nos. 0304041, 034042 or 175043

### Pressure Regulator Valve

- Direct replacement for Bendix 217380 & Midland KN31070
- Non-exhaust type regulator
- 3/8" NPTF delivery and supply ports
- 10-125 psi adjustable pressure gauge



| Part # | Description              |
|--------|--------------------------|
| 032060 | Pressure regulator valve |



Call the Velvac Sales Team: **800.783.8871** sales@velvac.com

## AIR TANK ACCESSORIES

### Air Dryer Replacement Cartridges



- All include seal rings

| Part # | Description                | Replaces                                                                                                 |
|--------|----------------------------|----------------------------------------------------------------------------------------------------------|
| 034046 | Fits AD-SP type air dryers | Bendix 109994, Bosch 1-487-434-901 & WABCO 432-410-020-2, 432-420-220-2<br>(also fits System Saver 1200) |
| 034047 | Fits AD-4 air dryers       | Bendix 103981, 104358                                                                                    |
| 034048 | Fits AD-9 air dryers       | Bendix 107794, 107796                                                                                    |

### AD-9 Air Dryer Rebuild Purge Kits



- Installation instructions and all necessary lubricants included
- 12 and 24 VDC heater/thermostat kits also sold separately. These include the heater/thermostat assembly, seal rings and mounting hardware

| Part # | Description                                                                                                      | Replaces                                 |
|--------|------------------------------------------------------------------------------------------------------------------|------------------------------------------|
| 034087 | Purge valve kit w/ purge piston assembly                                                                         | Bendix 5005037, 5004336, 5004337, 107798 |
| 034088 | Purge assembly kit - 12V<br>(includes aluminum purge housing, purge valve kit and 12V heater/thermostat kit)     | Bendix 800405                            |
| 034089 | Purge assembly kit - 24 Volt<br>(includes aluminum purge housing, purge valve kit and 24V heater/thermostat kit) | Bendix 5004338                           |
| 034092 | Heater/thermostat kit only - 12V                                                                                 | Bendix 109578                            |

### Air Dryer Wiring Harness

- Direct replacement for Bendix 109869, 109871, 298948 
- Fits both 12 and 24 volt AD-9, AD-SP, AD-IP and System Saver 1200 units
- 22" leads

| Part # | Description              |
|--------|--------------------------|
| 034091 | Air dryer wiring harness |

### Safety Valves (ST-3 and ST-4 Styles)

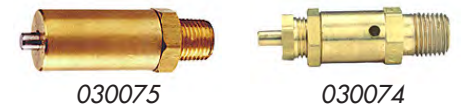

- ST-3 Style
- Automatic pressure release at 150 psi
- 1/4" NPT
- Adjustable valve preset to 125 psi by factory; adjustable from 41-149 psi

| Part # | Description             | Replaces                                 |
|--------|-------------------------|------------------------------------------|
| 030075 | Safety valve            | Bendix 284142 & Midland KN31200, KN31400 |
| 030074 | Adjustable safety valve | Bendix 205105                            |

- ST-4 Style 
- 1/4" NPT 034090
- Automatic pressure release at 150 psi
- Low profile valve fits AD-9, AD-SP, AD-IP, and System Saver 1200 air dryers

| Part # | Description  | Replaces      |
|--------|--------------|---------------|
| 034090 | Safety valve | Bendix 800350 |

## AIR TANK ACCESSORIES

### Single Check Valves



034044



320014



320001



034045



320003

| Part # | Description         | Replaces                                                |
|--------|---------------------|---------------------------------------------------------|
| 034044 | 1/4" Threads        | Bendix 229603, 800375                                   |
| 320014 | 3/8" Threads        | Bendix 227870, 800373 & Midland KN23010                 |
| 320001 | 1/2" Threads        | Bendix 227717, 227788, 227871, 800372 & Midland KN23000 |
| 034045 | 1/2" Female threads | Bendix 800370                                           |
| 320003 | 3/4" Threads        | Midland KN23040                                         |

### Air Tank Drain Cocks



036003



036019,  
036020



036021

- 1/4" MPT (except 036020)

| Part # | Description                        |
|--------|------------------------------------|
| 036003 | Lever handle drain cock            |
| 036019 | Back seating drain cock - 1/4" MPT |
| 036020 | Back seating drain cock - 3/8" MPT |
| 036021 | Wing handle drain cock             |

### Drain Pull Valves



- Attached vinyl coated aircraft cable
- .075" diameter cable
- 1/4" MPT
- 120 psi maximum pressure

| Part # | Description                                                           |
|--------|-----------------------------------------------------------------------|
| 032135 | Valve with 3' cable                                                   |
| 032058 | Valve with 4' cable                                                   |
| 032082 | Valve with 5' cable                                                   |
| 032160 | Valve with 5' cable uncrimped on free end - includes one extra sleeve |
| 032081 | Valve without cable                                                   |
| 032170 | 100' Bulk cable                                                       |
| 032083 | Replacement 5' cable & sleeves                                        |
| 032185 | Replacement cable sleeve                                              |

### Automatic Reservoir Drain Valve (DV-2 Style)



Non-heated

- Direct replacement for Bendix 281923 & Midland KN24000
- All ports 3/8" NPT

| Part # | Description                     |
|--------|---------------------------------|
| 034043 | Automatic reservoir drain valve |

**NOTE: Part numbers listed in RED are NEW!**



Call the Velvac Sales Team: **800.783.8871** sales@velvac.com

## AIR TANKS, BRAKE CHAMBERS AND DIAPHRAGMS

### Air Tanks

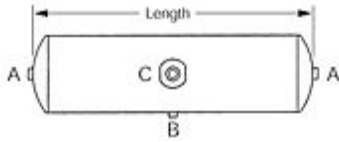

Type 1 - Bracket Mounted

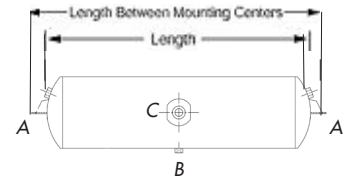

Type 2 - Flange Mounted

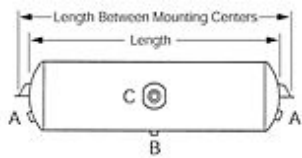

Type 3 - Flange Mounted

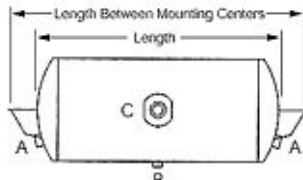

Type 4 - Flange Mounted

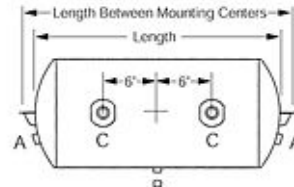

Type 5 - Flange Mounted

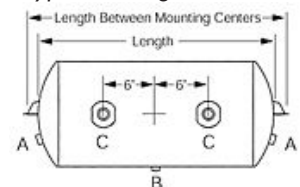

Type 6 - Flange Mounted

- All tanks feature dual main ports except Part No 035103
- All steel construction
- All tanks are water tested prior to shipping
- Dipped tanks are rust resistant and primer sealed
- Internally corrosion resistant
- Tanks meet SAE J10 requirements

### Air Tank Check Valve Kit

- Provides a second dry air reservoir
- Kit includes 1425 cu. in. air tank, mounting brackets, one-way check valve, reducer bushing and 1/4" drain plug

| Part # | Description              |
|--------|--------------------------|
| 131045 | Air tank check valve kit |

### Air Tank Mounting Brackets



- For tanks up to 8-3/16" in diameter

| Part # | Description                |
|--------|----------------------------|
| 501051 | Air tank mounting brackets |

| Part #   | Tank Type | Diameter | Length  | A    | B    | C    | Cu. in. Capacity | Mounting Centers |
|----------|-----------|----------|---------|------|------|------|------------------|------------------|
| 035103*  | 1         | 8"       | 29-1/4" | 1/2" | 1/4" | 3/4" | 1425             | -                |
| 035101   | 2         | 8"       | 29-1/4" | 3/8" | 1/4" | 3/4" | 1425             | 32"              |
| 035102   | 3         | 8"       | 29-1/4" | 3/8" | 1/4" | 3/4" | 1425             | 32"              |
| 035106   | 3         | 9-1/2"   | 22-1/2" | 3/8" | 1/4" | 3/4" | 1488             | 27-1/2"          |
| 035104   | 4         | 9-1/2"   | 22-1/2" | 3/8" | 1/4" | 3/4" | 1488             | 27-1/2"          |
| 035105   | 4         | 9-1/2"   | 22-1/2" | 1/2" | 1/4" | 3/4" | 1488             | 27-1/2"          |
| 035108   | 3         | 12"      | 27"     | 3/8" | 1/4" | 3/4" | 2850             | 29-1/2"          |
| 035107** | 5         | 12"      | 27"     | 3/8" | 1/4" | 3/4" | 2850             | 29-1/2"          |
| 035109** | 6         | 12"      | 27"     | 3/8" | 1/4" | 3/4" | 2850             | 29-1/2"          |

\* This tank can also be used for vacuum applications - also see mounting brackets Part No. 501051

\*\* Dual main ports on same side of tank-ports are 12" apart on center

### Air Brake Chambers



- Direct replacement for all popular service brake chambers
- Fully threaded shaft for maximum adjustability
- Mounting hardware, clevis and cotter pin included

| Part # | Dia.   | Type | Working Stroke |
|--------|--------|------|----------------|
| 030013 | 5.785" | 12   | 1-3/4"         |
| 030015 | 6.5"   | 16   | 2-1/4"         |
| 030017 | 7"     | 20   | 2-1/4"         |
| 030019 | 7.5"   | 24   | 2-1/2"         |
| 030021 | 8.25"  | 30   | 2-1/2"         |

### Air Brake Diaphragm



- Gas and oil resistant
- Rubber/neoprene blend
- Fabric reinforced for extra strength and long life

| Part # | Diameter | Type |
|--------|----------|------|
| 031021 | 6"       | 9    |
| 031023 | 5.5"     | 12   |
| 031025 | 6"       | 16   |
| 031027 | 6.5"     | 20   |
| 031031 | 7"       | 24   |
| 031033 | 8"       | 30   |
| 031035 | 9"       | 36   |

## AIR CYLINDER CONTROL VALVES

- Anodized aluminum black bodies
- Nitrile seals for long cycle life
- High impact knobs
- Balanced spool design
- Operating temperature range from -40° F to +180°F
- Stainless steel hardware
- Normal operating pressure 100 psi

### Four-Way Push/Pull Valves



- Aluminum shaft with delrin detent ring provides easy ID of valve position
- Threaded aluminum mounting boss for 1" diameter through hole mounting (nuts included)
- (3) 9/32" dia. body mounting holes
- (5) 1/4" - 18 FPT ports
- Normal operating pressure 100 psi
- Includes two faceplates:
  - » Pull to open/Push to close
  - » Pull to raise/Push to lower

### Applications for valves:

- Two position valve operates any double acting air cylinder
- Three position valve operates systems where full air or vacuum pressure must be isolated

| Part # | Description                           |
|--------|---------------------------------------|
| 320175 | 2-position valve                      |
| 320176 | 3-pos, holding type valve             |
| 320125 | Replacement knob, faceplates and nuts |

### Viper™ Four-Way Push/Pull



- One piece stainless steel shaft
- Can be mounted using (2) 3/16" diameter body mounting holes or through a 1/2" diameter through hole
- (3) 1/8" NPT ports, (2) 10-32 exhaust ports
- Includes faceplate

| Part # | Description            |
|--------|------------------------|
| 320177 | "Viper" four-way valve |

Viper™ is a trademark of Velvac, Inc.

### Four-Way Rotary Handle Valve



- Three position valve
- (3) 1/4" - 18 FPT ports
- 1/4" NPT threaded exhaust ports
- (2) 1/4" diameter body mounting holes at 1-15/16" on center
- Operating pressure to 150 psi
- Includes solid one-piece handle and two faceplates (Raise/Lower and Open/Close)

| Part # | Description           |
|--------|-----------------------|
| 320179 | Rotary handle valve   |
| 321034 | Raise/Lower faceplate |
| 030092 | 1/4" Cone filter      |

### Four-Way Push/Pull Compact Design Valve

- The compact design fits into today's small dash board designs
- Pneumatic valve is designed to control the operations of a typical air cylinder
- 150 psi max air pressure
- 0.4 Cv air flow
- Aluminum body and end caps
- 40 micron filtration

### Four-Way Electronic Solenoid Valve



- Operates any single acting or pressure double acting air cylinder
- Actuated with a std On/Off switch
- Air-piloted assist
- (5) 1/4" -18 FPT port
- (3) 9/32" dia valve body mtg holes
- Normal operating pressure 100psi
- Exhaust cone filters included

| Part # | Description           |
|--------|-----------------------|
| 320178 | 4-way solenoid        |
| 320132 | Electrical coil       |
| 320133 | Solenoid mounting nut |
| 030092 | 1/4" Cone filter      |
| 030084 | 1/8" Cone filter      |

### Four-Way Mini Electronic Solenoid Valve



- Compact design - 4" overall length
- Air-piloted assist
- 1/8" supply and delivery ports
- 10-32 exhaust ports
- 12VDC coil with low 2 watt draw
- Normal operation pressure
- 100 psi

| Part # | Description         |
|--------|---------------------|
| 320180 | 4-way mini solenoid |
| 030093 | 10-32 Cone filter   |



| Part # | Description    | Parker #  |
|--------|----------------|-----------|
| 320187 | Four-way valve | 410939002 |



Call the Velvac Sales Team: **800.783.8871** sales@velvac.com

## AIR CYLINDERS

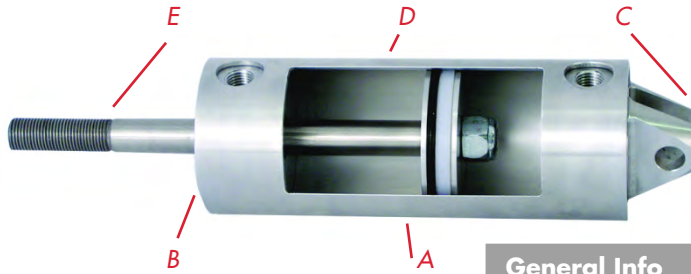

Backed by a 3 year warranty

Velvac's heavy-duty Enforcer™ series of air cylinders are built tough for long life and made from some of the strongest materials available today!

- Machined from 6061 series aluminum, 303 stainless steel, with Nitrile "O" rings and a UHMW polyethylene wear band
- Cycle tested into the millions. The solid construction means the cylinders will keep on working even in extreme conditions where other air cylinders fail. These cylinders are available in push/pull, solenoid operated and spring return versions

| General Info          | Feature | Type                                                                                           |
|-----------------------|---------|------------------------------------------------------------------------------------------------|
| Cylinder Construction | A       | Aluminum cylinder tubing with a 16 RMS finish, lock ring construction secures end caps to tube |
| Front Cover           | B       | Solid aluminum with oilight bronze bushing, Delrin seal and 1/4" NPT port                      |
| Rear Cover            | C       | Solid aluminum with mounting hole for 1/2" clevis pin and 1/4" NPT port                        |
| Piston Cup            | D       | Solid aluminum with Nitrile "O" ring rated at -40° to +185°F and UHMW polyethylene wear band   |
| Piston Rod            | E       | 5/8" diameter 303 series stainless steel with 5/8" - 18 thread                                 |
| Temp Rating           | -       | -40° to +185°F                                                                                 |
| Pressure Rating       | -       | 10 psi minimum to 150 psi maximum<br>Standard operating pressure 100 psi                       |

### 2-1/2" Air Cylinder



| Part # | Cylinder Type | Stroke | Retracted Length | Extended Length | Thrust at 100 psi | Draw at 100 psi |
|--------|---------------|--------|------------------|-----------------|-------------------|-----------------|
| 100204 | Push/Pull     | 4"     | 9.89"            | 13.89"          | 491 lb            | 460 lb          |
| 100226 | Spring Return | 6"     | 13.75"           | 19.75"          | 251 lb            | 460 lb          |
| 100206 | Push/Pull     | 6"     | 11.89"           | 17.89"          | 491 lb            | 460 lb          |
| 100208 | Push/Pull     | 8"     | 13.89"           | 21.89"          | 491 lb            | 460 lb          |

### 3-1/2" Air Cylinder

| Part # | Cylinder Type | Stroke | Retracted Length | Extended Length | Thrust at 100 psi | Draw at 100 psi |
|--------|---------------|--------|------------------|-----------------|-------------------|-----------------|
| 100308 | Push/Pull     | 8.68"  | 15.60"           | 24.28"          | 962 lb            | 930 lb          |
| 100310 | Bullet Type   | 10"    | 16.92"           | 26.95"          | 962 lb            | 930 lb          |

## AIR CYLINDER CONTROL VALVES

### Cone Filters



| Part # | Description       |
|--------|-------------------|
| 030093 | 10-32 Cone filter |
| 030084 | 1/8" Cone filter  |
| 030092 | 1/4" Cone filter  |
| 030094 | 3/8" Cone filter  |

NOTE: Air cylinders and tailgate kits are designed to operate the locking linkage on dump bodies and are NOT to be used as a means of mechanically holding the tailgate shut. Custom kits are available - contact Velvac for more information

Enforcer™ is a trademark of Velvac, Inc.

## AIR CYLINDERS



Velvac's standard series of air cylinders are built for durability with a reputation for quality and affordability!

- Used in a wide variety of applications and conditions and can take the daily abuse associated with typical tailgate applications
- Backed with a 1 year warranty and 100% tested
- Available in push/pull, solenoid operated and spring return versions

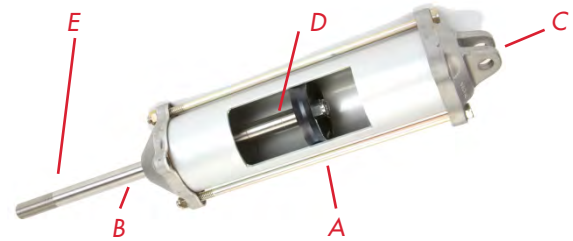

| General Info          | Feature | Feature/Benefit                                                                                                  |
|-----------------------|---------|------------------------------------------------------------------------------------------------------------------|
| Cylinder Construction | A       | Smooth cylinder grade aluminum tubing with a 32 RMS finish, tie rod construction secures end caps to tube        |
| Front Cover           | B       | Die cast aluminum with Nitrile dirt wiper and pressure seal and oil impregnated bronze bushing and 1/4" NPT port |
| Rear Cover            | C       | Die cast aluminum with mounting hole for 1/2" clevis pin and 1/4" NPT port                                       |
| Piston Cup            | D       | Emralon-coated, single piece, molded piston cup                                                                  |
| Piston Rod            | E       | 5/8" diameter 300 series stainless steel with 5/8" - 18 thread                                                   |
| Temp Rating           | -       | -20° to +185°F                                                                                                   |
| Pressure Rating       | -       | 10 psi minimum to 120 psi maximum<br>Standard operating pressure 100 psi                                         |

### 2-1/2" Air Cylinder

At 100 psi:

- Thrust: 483 lb
- Draw: 452 lb

| Part # | Cylinder Type            | Stroke | Retracted Length | Extended Length |
|--------|--------------------------|--------|------------------|-----------------|
| 100122 | Push/Pull                | 4"     | 9.89"            | 13.89"          |
| 100125 | Spring Return Norm. Ext. | 4"     | 10.62"           | 14.62"          |
| 100123 | Push/Pull                | 6"     | 11.89"           | 17.89"          |
| 100126 | Spring Return Norm. Ext. | 6"     | 13.89"           | 19.89"          |
| 100124 | Push/Pull                | 8"     | 13.89"           | 21.89"          |

### 3-1/2" Air Cylinder

At 100 psi:

- Thrust: 962 lb
- Draw 918 lb

\*Kit contains air cylinder Part No. 100132 and extended clevis kit #019051. Use this kit when replacing previous cylinder Part No. 101028

| Part #  | Cylinder Type | Stroke | Retracted Length | Extended Length |
|---------|---------------|--------|------------------|-----------------|
| 100131  | Push/Pull     | 6.68"  | 13.60"           | 20.28"          |
| 100132  | Push/Pull     | 8.68"  | 15.60"           | 24.28"          |
| 100136  | Push/Pull     | 8.68"  | 18.43"           | 27.12"          |
| 100137* | Push/Pull     | 8.68"  | 15.60"           | 24.28"          |

NOTE: Air cylinders and tailgate kits are designed to operate the locking linkage on dump bodies and are NOT to be used as a

means of mechanically holding the tailgate shut. For tailgate kits see page A33. Custom kits are also available - contact Velvac for information



Call the Velvac Sales Team: **800.783.8871** sales@velvac.com



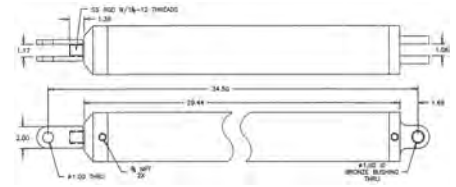

Backed by a 3 year warranty

### High Lift Cylinder

| General Information |                                                                                              | Type |
|---------------------|----------------------------------------------------------------------------------------------|------|
| Cylinder Tube       | Aluminum cylinder tubing with a 16 RMS finish                                                |      |
| Front Cover         | Solid aluminum with oil tight bronze brushing, Delrin seal and 3/8" NPT port                 |      |
| Rear Cover          | Solid aluminum with mounting hole for 1" clevis pin and 3/8" NPT port                        |      |
| Piston Cup          | Solid aluminum with Nitrile "O" ring rated at -40° to +185°F and UHMW polyethylene wear band |      |
| Temp Rating         | -40° to +185°F                                                                               |      |
| Pressure Rating     | Standard operating pressure 100 psi, 10 psi minimum to 150 psi maximum                       |      |

| Part # | Bore | Cylinder Type | Stroke | Retracted Length | Extended Length | Thrust at 100 psi | Draw at 100 psi |
|--------|------|---------------|--------|------------------|-----------------|-------------------|-----------------|
| 100424 | 4"   | Push/Pull     | 24"    | 34.5"            | 58.5"           | 1,275 lb          | 1,158 lb        |

### Tailgate Cylinders

- Velvac's Enforcer series of tailgate cylinders is the best choice for any tailgate
- Machined from 6061 series aluminum, 5/8" diameter 303 stainless steel shaft with 5/8" - 18 threads, Nitrile "O" rings and a UHMW polyethylene wear band
- Direct replacements to

Haldex and MGM

- Standard operating pressure 100 psi, 90 psi minimum to 150 psi maximum



| Part # | Bore | Cylinder Type           | Stroke | Retracted Length | Extended Length | Thrust at 100 psi | Draw at 100 psi |
|--------|------|-------------------------|--------|------------------|-----------------|-------------------|-----------------|
| 100603 | 6"   | Spring return           | 3"     | 16.18"           | 19.18"          | 400 lb            | 2,400 lb        |
| 100613 | 6"   | Spring return           | 4.38"  | 18.62"           | 23"             | 1,417 lb          | 1,400 lb        |
| 100614 | -    | *Bracket kit for 100613 | -      | -                | -               | -                 | -               |
| 100615 | -    | *Spacer kit for 100613  | -      | -                | -               | -                 | -               |

NOTE: Extended/retracted lengths are measured from the tip of the shaft to the end of the cylinder

\*The bracket kit is used for new MGM installations, while the spacer kit is used when replacing the existing MGM cylinder

## AIR CYLINDER TAILGATE LOCK KITS

### Velvac Original



| Part # | Cylinder Diameter/Stroke                                                                                                                                    |
|--------|-------------------------------------------------------------------------------------------------------------------------------------------------------------|
| 100022 | 2-1/2" x 8" Kit, contents as shown                                                                                                                          |
| 100028 | 2-1/2" x 8" Kit, contents as shown, plus 50' of 3/8" black nylon tubing and clips                                                                           |
| 101002 | 3-1/2" x 8" Kit, contents as shown, plus 50' of 3/8" black nylon tubing and clips and extended clevis kit Part No. 019051 (see FITTINGS & HARDWARE section) |

| Part # | Cylinder Diameter/Stroke           |
|--------|------------------------------------|
| 101054 | 2-1/2" x 8" Kit, contents as shown |
| 101058 | 3-1/2" x 8" Kit, contents as shown |

| Part # | Cylinder Diameter/Stroke           |
|--------|------------------------------------|
| 101055 | 2-1/2" x 8" Kit, contents as shown |
| 101059 | 3-1/2" x 8" Kit, contents as shown |

| Part #   | Cylinder Diameter/Stroke                                       |
|----------|----------------------------------------------------------------|
| 100144-7 | 3-1/2" x 8" Kit, contents as shown - designed to fit Ox bodies |

| Part # | Cylinder Diameter/Stroke                              |
|--------|-------------------------------------------------------|
| 100036 | 2-1/2" x 6" Kit                                       |
| 100037 | 2-1/2" x 8" Kit                                       |
| 101003 | 3-1/2" x 8" Kit with extended clevis, Part No. 019051 |
| 101004 | 3-1/2" x 6" Kit                                       |
| 101078 | 3-1/2" x 8" Kit with clevis Part No. 019049           |

- Solenoid operated cylinder kits allow the operator to electronically unlock tailgate without leaving the cab
- All kits include clevis and pins, electrical switch part No. 090177, cylinder with four-way solenoid attached

## FIFTH WHEEL AIR CYLINDERS



- Cast aluminum front and rear cover with 1/4" FTP port
- 100 psi operating pressure
- Mounting hole for 17/32" clevis, front and rear
- Gold anodized tube for corrosion resistance

| Part # | Bore   | Stroke | Replaces               | Retracted Length | Extended Length |
|--------|--------|--------|------------------------|------------------|-----------------|
| 100101 | 2-1/2" | 6-3/4" | Holland XA-2524-R      | 12-5/8"          | 19-13/32"       |
| 100102 | 3-1/2" | 2"     | Holland XA-2524-R-13-1 | 7-21/32"         | 9-21/32"        |



Call the Velvac Sales Team: **800.783.8871** [sales@velvac.com](mailto:sales@velvac.com)

## LIFT AXLE AND SUSPENSION VALVES

### Manual Push/Pull Valves

- High flow dual pressure air valves for lift axles, suspension dump systems and tailgate control
- Solid aluminum construction
- Nitrile seals for long cycle life
- High impact knobs with face plates
- Balanced stainless steel and aluminum spool design
- Operating temperature range from -40° to +180°F
- Stainless steel hardware
- Normal operating pressure 100 psi



320188



320184



320192



320146

| Part # | Description                                                                  | Valve Type | Ports    | Air Flow | Applications                                                  | Schematic |
|--------|------------------------------------------------------------------------------|------------|----------|----------|---------------------------------------------------------------|-----------|
| 320188 | "Mini" valve w/ built in exhaust filter                                      | 3 Way      | 1/4" NPT | 1.5 Cv   | Single acting air cylinders, lift axles or suspension systems |           |
| 320184 | Valve w/ remote 1/4" NPT exhaust air pilot reset option                      | 3 Way      | 3/8" NPT | 2.2 Cv   | Single acting air cylinders, lift axles or suspension systems |           |
| 320192 | 3 position valve with center exhaust feature                                 | 4 Way      | 1/4" NPT | 1.5 Cv   | Single or double acting air cylinders                         |           |
| 320146 | 2 position with soft 4 way detent and 1/8" NPT remote air pilot reset option | 4 Way      | 3/8" NPT | 2.2 Cv   | Single acting air cylinders, lift axles or suspension systems |           |

### Lift Axle Control Valve

- Designed for the heavy duty truck and trailer industry
- Includes two industry-proven brake-style relay valves integrated into a single unit for compactness and ease of installation
- Excellent flow capability for rapid axle actuation
- Optional control solenoid for electric control operating system

| Part # | Description             |
|--------|-------------------------|
| 034139 | Lift axle control valve |

**NOTE:**  
Part numbers listed in RED are NEW!



### Silicone Lubricant

- Specially formulated silicone lubricant protects and extends the life of air valves and air brake valves. Helps repair the drying effects caused by alcohol and antifreeze
- Light oil can be added directly into the air lines and the heavy oil can be added directly into the valves.



| Part # | Description                               |
|--------|-------------------------------------------|
| 320170 | Light weight oil - 4 oz bottle            |
| 320171 | Light weight oil - 5 pack of 4 oz bottles |
| 320172 | Heavy weight oil - 4 oz bottle            |
| 320173 | Heavy weight oil - 5 pack of 4 oz bottles |

#### Helpful hint:

To prevent damage to seals, premature air product failures,

### Brass Electric Coil Air Converter

- Solenoid override adapter mounts on the coil and allows the conversion of the electrical signal into an air signal
- 1/8" NPT ports
- Solid brass construction



| Part # | Description                       |
|--------|-----------------------------------|
| 320148 | Brass electric coil air converter |

and possible warranty claim rejection, many OE manufacturers instruct customers to avoid the use of petroleum based products and de-icing agents in their air systems. It is recommended to change the air dryer filters regularly and use silicone valve oils to help repair seal damage and extend the life of air valves

## LIFT AXLE AND SUSPENSION VALVES

### Solenoid Valves

- Solenoid valves allow the driver to operate single or double acting cylinders, lift axles or suspension dump systems electronically
- Constructed with the same materials as Velvac's air accessory valves
- Normal operating pressure 100 psi
- The solenoid valves have a 12-volt power consumption coil that uses only 4.8 watts



| Part # | Description                                                    | Valve Type | Ports    | Air Flow | Applications                                         | Schematic |
|--------|----------------------------------------------------------------|------------|----------|----------|------------------------------------------------------|-----------|
| 320185 | Spring return valve with 1/8" NPT external pilot               | 4 Way      | 3/8" NPT | 2.2 Cv   | Lift axles or suspension systems                     |           |
| 320181 | Spring return valve with internal pilot assist                 | 4 Way      | 3/8" NPT | 2.2 Cv   | Lift axles or suspension systems                     |           |
| 320186 | Spring return valve with internal manual override              | 4 Way      | 3/8" NPT | 2.2 Cv   | Lift axles                                           |           |
| 320189 | Spring return valve with air operated external manual override | 4 Way      | 3/8" NPT | 2.2 Cv   | Lift axles                                           |           |
| 320190 | Push-pull valve with solenoid air pilot return                 | 4 Way      | 3/8" NPT | 2.2 Cv   | Single or double acting air cylinders and lift axles |           |

### Air-Pilot Valves



| Part # | Description                                                    | Valve Type | Ports    | Air Flow | Applications       | Schematic |
|--------|----------------------------------------------------------------|------------|----------|----------|--------------------|-----------|
| 320191 | Air pilot spring return with 1/4" NPT air pilot supply support | 3 Way      | 3/8" NPT | 2.2 Cv   | Suspension systems |           |
| 320183 | Shuttle air pilot spring return valve                          | 4 Way      | 3/8" NPT | 2.2 Cv   | Lift axles         |           |
| 320182 | Air pilot spring return valve with 1/8" external pilot port    | 4 Way      | 3/8" NPT | 2.2 Cv   | Lift axles         |           |



Call the Velvac Sales Team: **800.783.8871** [sales@velvac.com](mailto:sales@velvac.com)

**OUR PARTS PUT YOU IN THE PASSING LANE**

# **ELECTRICAL**

**The only source you need.**

From our ISO and ABS coiled cables to plugs, fuses, sockets, terminals and switches, Velvac offers a full line of electrical components to keep drivers doing what they do best - driving.

- **Cable and plug assemblies**
- **Fuses, sockets, terminals and connectors**
- **Battery lugs and terminals**
- **And more**



## CABLE AND PLUG ASSEMBLIES

### Six-Way Coiled Cable Assembly



- 12' working length
- Durable black outer jacket resists abrasion and has excellent coil memory
- Heavy-duty zinc die cast plugs with spring guards included

| Part # | Working length | Description       |
|--------|----------------|-------------------|
| 590061 | 12'            | 6/14 Gauge        |
| 050029 | 12'            | Replacement cable |

### Single Pole Coiled Cable Assemblies



#### Tailgate Lift Power Cable

For applications that require direct electrical power to trailer lift gates; BLUE JACKETED

- Rated at 265 amps intermittent service (30 seconds on/50 seconds off)
- Heavy-duty zinc die cast plugs with spring guards included
- 2 gauge cable

| Part # | Description                            |
|--------|----------------------------------------|
| 590135 | 12' Tailgate lift power cable assembly |
| 590136 | 15' Tailgate lift power cable assembly |

#### Tailgate Lift

##### Battery Charging Cable

For applications where cables are used to charge trailer lift gate batteries; GREEN JACKETED, heavy-duty zinc die cast plugs with spring guards included

- 200 amp max for intermittent lift gate applications at 12 VDC
- 110 amp max for continuous applications at 12 VDC
- External ground option
- 4 gauge cable

| Part # | Description                                               |
|--------|-----------------------------------------------------------|
| 590263 | 12' Tailgate lift battery charging 4 gauge cable assembly |
| 590264 | 15' Tailgate lift battery charging 4 gauge cable assembly |

### Two Pole Coiled Cable Assemblies



- Rated at 200 amps for lift gate applications at 12 VDC
- 4 gauge cable
- Internally grounded
- Withstand temperatures of -85° to +185°F
- Durable black polyethylene outer jacket resists abrasions and chemical damage while offering excellent coil retention
- Heavy-duty zinc die cast plugs with springs guards included

| Part # | Description                                 |
|--------|---------------------------------------------|
| 590171 | 12' Two pole coiled cable assembly          |
| 590172 | 15' Two pole coiled cable assembly          |
| 590181 | 12' Vertical two pole coiled cable assembly |
| 590182 | 15' Vertical two pole coiled cable assembly |

**NOTE: Part numbers listed in RED are NEW!**



Call the Velvac Sales Team: **800.783.8871** sales@velvac.com

## SEVEN-WAY COILED CABLE ASSEMBLIES



### Seven-Way ISO Coiled Cable Assemblies

- Used in tractor/trailer systems requiring ISO 3731 style connectors; ISO pin prevents connections with non-ISO sockets
- 1/8, 2/10, 4/12 gauge cable
- Durable yellow outer jacket resists abrasion, provides excellent coil retention and offers quick identification of auxiliary circuit lines
- Heavy-duty zinc die cast plugs with spring guards included

| Part # | Working Length | Description              |
|--------|----------------|--------------------------|
| 590251 | 12'            | 2-12" Leads              |
| 590252 | 15'            | 2-12" Leads              |
| 590253 | 15'            | 1-48" Lead<br>1-12" Lead |
| 590254 | 15'            | 1-72" Lead<br>1-12" Lead |



### Seven-Way ABS Coiled Cable Assemblies

- Assemblies include heavy gauge wire commonly used to power trailer and dolly ABS
- 1/8, 2/10, 4/12 gauge cable
- Durable green outer jacket resists abrasion, provides excellent coil retention and offers quick identification of ABS lines
- Heavy-duty zinc die cast plugs with spring guards included
- Cable meets SAE J2394 June 1998 Type F requirements

| Part # | Working Length | Description              |
|--------|----------------|--------------------------|
| 590160 | 12'            | 2-12" Leads              |
| 590161 | 15'            | 2-12" Leads              |
| 590163 | 15'            | 1-40" Lead<br>1-12" Lead |
| 590080 | 20'            | 2-12" Leads              |
| 590081 | 20'            | 1-12" Lead<br>1-40" Lead |

NOTE: See page E8 for ABS color code chart



### Seven-Way Coiled Cable Assemblies

- Durable black outer jacket resists abrasion and provides excellent coil retention
- Heavy-duty zinc die cast plugs with spring guards included
- Operating temperature range of -55° to +185°F

| Part # | Working Length | Description                                     |
|--------|----------------|-------------------------------------------------|
| 590154 | 12'            | 6/12, 1/10 Gauge<br>(2-12" Leads)               |
| 590156 | 12'            | 6/14, 1/12 Gauge<br>(2-12" Leads)               |
| 590155 | 15'            | 6/12, 1/10 Gauge<br>(2-12" Leads)               |
| 590157 | 15'            | 6/14, 1/12 Gauge<br>(2-12" Leads)               |
| 590159 | 15'            | 6/12, 1/10 Gauge<br>(1-72" Lead,<br>1-12" Lead) |



### Seven-Way ABS & ISO Straight Cable Assemblies

- ISO assemblies used in tractor/trailer systems requiring ISO 3731 style connectors

| Part # | Working Length | Description              |
|--------|----------------|--------------------------|
| 590255 | 12'            | 1/8, 2/10,<br>4/12 Gauge |
| 590256 | 15'            | 1/8, 2/10,<br>4/12 Gauge |

- ABS assemblies include heavy gauge wire commonly used to power trailer and dolly ABS - ABS cable meets SAE J2394 June 1998 Type F requirements

| Part # | Working Length | Description              |
|--------|----------------|--------------------------|
| 590165 | 12'            | 1/8, 2/10,<br>4/12 Gauge |
| 590166 | 15'            | 1/8, 2/10,<br>4/12 Gauge |
| 590179 | 20'            | 1/8, 2/10,<br>4/12 Gauge |

- Heavy-duty zinc die cast plugs with spring guards included

| Part # | Working Length | Description      |
|--------|----------------|------------------|
| 590180 | 5'             | 6/12, 1/10 Gauge |
| 590036 | 8'             | 6/12, 1/10 Gauge |
| 590046 | 12'            | 6/12, 1/10 Gauge |
| 590177 | 10'            | 6/12, 1/10 Gauge |
| 590178 | 15'            | 6/12, 1/10 Gauge |

## ELECTRICAL PLUGS

ISO plug



T-grip

Plastic plug with weather guard



### Seven-Way Plugs

- Heavy-duty nickel-plated zinc die cast housings on all except plastic plug, which has an unbreakable nylon housing
- Easy to remove interiors make for quick replacements
- ATA color-coded wire terminals
- Internal clamp holds cable securely in place
- Standard seven-way plugs meet ATA and SAE J560 requirements; ISO plugs meet ISO 3731: 1997 requirements

### T-Grip Seven-Way Plugs

| Part # | Description                             |
|--------|-----------------------------------------|
| 593057 | Plug with spring guard                  |
| 593101 | ISO plug with spring guard              |
| 593111 | Plastic plug with weather guard         |
| 593019 | Replacement interior for 593057, 593111 |
| 593060 | Replacement spring guard                |

### Single Grip Seven-Way Plugs

| Part # | Description               |
|--------|---------------------------|
| 593022 | Plug with spring guard    |
| 593024 | Plug without spring guard |
| 593019 | Replacement interior      |
| 593029 | Replacement spring guard  |



591161



591105

### Single Pole Plugs

- Used to provide power to heavy draw auxiliary trailer equipment
- Heavy-duty zinc die cast housings
- Power and ground terminals hold up to 1/0 gauge wire

| Part # | Description                           |
|--------|---------------------------------------|
| 591161 | T-grip plug with spring guard         |
| 591105 | Single grip plug without spring guard |



### Seven-Way Blade Type Plug

- Primarily used in RV applications
- Constructed of molded PVC for impact resistance

| Part # | Description               |
|--------|---------------------------|
| 054001 | Seven-way blade type plug |

NOTE: See page E6 for seven-way blade type socket



593116



593123

### Two Pole Plug

- 200 amp, 4 gauge wire capacity
- Heavy-duty zinc die cast housings
- Internal ground
- Spring guard supports and protects cable

| Part # | Description                   |
|--------|-------------------------------|
| 593116 | T-grip plug with spring guard |
| 593123 | Vertical T-grip plug w/ guard |

Plug with spring guard



Plug without spring guard



### Four-Way and Six Way Plugs

- Heavy-duty zinc die cast housings
- Plug locking system works with socket door to ensure proper hookup and prevent unintentional disconnections
- Spring guard 055049 supports and protects cable

| Part # | Description                           |
|--------|---------------------------------------|
| 055059 | Four-way plug with spring guard       |
| 055054 | Four-way plug without spring guard    |
| 055049 | Six-way plug with spring guard        |
| 055050 | Six-way plug without spring guard     |
| 055051 | Replacement interior for six-way plug |



Call the Velvac Sales Team: **800.783.8871** sales@velvac.com



## PLUG ADAPTERS AND ACCESSORIES

Female Pins



591009



057118



### Four-Way Flat Set

- Set: 48" lead (female) side and 12" lead (male) side
- Single: 48" leads
- Constructed of molded PVC for impact resistance
- ATA color-coded:  
White: Ground  
Green: Right turn and brake lights  
Yellow: Left turn and brake lights  
Brown: Tail lights

Male Pins



591010



057119



591116



057120



057121

### Truck Tractor to Trailer Adapters

- Heavy-duty zinc die cast housing on part nos. 591009 and 591010; also includes split brass pins and terminals and a spring clip to lock adapter and plug together
- Part no. 591116 constructed of molded PVC for impact resistance

| Part # | Description                              |
|--------|------------------------------------------|
| 591009 | Seven-way pin to six-way adapter         |
| 591010 | Six-way round to seven-way adapter       |
| 591116 | Seven-way round to four-way flat adapter |

### Continuity Testers

- LED indicators quickly identify complete circuits by glowing red; no light means problem circuit
- Fits standard seven-way blade type, four-way flat connectors and seven-way round
- Constructed of molded PVC for impact resistance
- Internally grounded

| Part # | Description                     |
|--------|---------------------------------|
| 057118 | Seven-way plug circuit tester   |
| 057119 | Seven-way socket circuit tester |
| 057120 | Seven-way blade circuit tester  |
| 057121 | Four-way flat circuit tester    |



### Seven-Way Plug Cleaner

- Stainless steel brushes quickly clean electrical contacts for improved conductivity
- Durable plastic body

| Part # | Description            |
|--------|------------------------|
| 055034 | Seven-way plug cleaner |

**NOTE: Part numbers listed in RED are NEW!**

## ELECTRICAL SOCKETS AND ACCESSORIES

### Seven-Way Circuit Breaker Sockets and Adapter Boxes

- Non-corrosive, reinforced nylon housing for added durability
- Designed for #8 ring terminals (see page E27)
- ATA color-coded contacts (see page E8 for ATA color code chart)
- Solid brass split pins are zinc-plated for corrosion resistance

- Each socket includes automatic reset circuit breakers with positive snap open/snap closed action to eliminate arcing (unless noted)
- Mounting holes are 4-1/2" on center and include steel bushings for added housing protection
- Adhesive-backed mounting gasket included
- Circuit breaker sockets meet SAE J560 requirements



- Durable zinc die cast housings
- Solid brass split pin socket offers replaceable circuit breakers for circuit protection of trailer wiring systems
- Slanted door front for plug support
- Replaceable thermoplastic base plate with ATA color codes for quick identification
- Each socket includes automatic reset circuit breakers with positive snap open/snap closed action to eliminate arcing

| Part #  | Description                                                                                        |
|---------|----------------------------------------------------------------------------------------------------|
| 055037  | Socket with 20 amp circuit breakers                                                                |
| 055038  | Socket with 30 amp circuit breakers                                                                |
| 055040  | Socket without circuit breakers                                                                    |
| 055039  | Replacement cover kit (includes cover, shaft retainer, steel hinge pin and stainless steel spring) |
| 055041* | Deep adapter box with bottom entry                                                                 |
| 055045* | Deep adapter box with back entry                                                                   |



Deep adapter box with back entry



Deep adapter box with bottom entry

\*5/16" - 18" UNC cover plate studs and 2" inside depth

| Part # | Description                         |
|--------|-------------------------------------|
| 593052 | Socket with 20 amp circuit breakers |
| 593054 | Socket with 30 amp circuit breakers |

### Single and Two Pole Sockets

- Durable zinc die cast housings
- Power and ground terminals on single pole socket hold up to 1/0 gauge wire
- 200 amp, 4 gauge wire capacity on two pole socket
- Two pole socket has internal ground
- Single pole socket may be soldered or crimped

- Mounting holes 3" on center
- Rear housing 1-3/4" O.D.

| Part # | Description                                 |
|--------|---------------------------------------------|
| 591113 | Single pole socket                          |
| 593121 | Two pole socket                             |
| 593124 | Vertical two pole socket                    |
| 591090 | Replacement interior for single pole socket |



593113



593124



593121

### Seven-Way Blade Type Socket

- Screw-type socket primarily used in RV applications
- 6-24 VDC
- Mounting holes are 2-1/4" on center
- Constructed of molded PVC for impact resistance

| Part # | Description                 |
|--------|-----------------------------|
| 054002 | Seven-way blade type socket |
| 090216 | Mounting bracket            |

NOTE: See page E4 for seven-way blade type plug



Optional mounting bracket



Call the Velvac Sales Team: **800.783.8871** sales@velvac.com

## ELECTRICAL SOCKETS AND ACCESSORIES

Two hole socket with screw terminals



Two hole socket with push terminals



Optional terminal protector boot



593083



Optional terminal protector boot



### ISO Seven-Way Socket

- Used in tractor/trailer systems requiring ISO 3731 style connectors - ISO socket prevents connections with non-ISO plugs
- ISO color-coded yellow, non-corrosive, reinforced nylon housing
- Wires secured by set screws
- Mounting holes are 2-15/16" on center

| Part # | Description             |
|--------|-------------------------|
| 593106 | ISO socket              |
| 054017 | Terminal protector boot |

### Seven-Way Sockets

- Non-corrosive, reinforced nylon housing for added durability
- Screw type socket with split pins designed for #8 ring terminals (see page E27)
- Push type socket with solid pins designed for 180° snap receptacles (see Part No. 056079 on page E26)
- Mounting holes are 3" on center
- Screw type socket includes screws and washers
- Gasket included on each socket
- Sockets meet SAE J560 requirements
- Protective rubber boot seals out moisture and contaminants - sold separately

| Part # | Description                          |
|--------|--------------------------------------|
| 055043 | Two hole socket with screw terminals |
| 055062 | Two hole socket with push terminals  |
| 055063 | Rubber terminal protector boot       |

- Durable zinc die cast housings
- ABS plastic interior with ATA color codes for quick identification
- Solid brass pins
- Wires attached by set screw retainers
- Slanted door front for plug support
- Tongue and groove door design protects socket interior from dirt and moisture
- Mounting holes are 2-15/16" on center
- 1-13/16" rear housing length
- Terminal protector boot keeps terminals free from moisture and contaminants - sold separately
- Sockets meet SAE J560 requirements (SAE applies only to solid pins)

| Part # | Description                                               |
|--------|-----------------------------------------------------------|
| 593083 | Socket with solid pins                                    |
| 593084 | Socket with split pins                                    |
| 054017 | Terminal protector boot                                   |
| 591022 | Replacement solid pin interior                            |
| 591019 | Replacement cover kit (includes door, hinge pin & spring) |



Optional terminal protector boot

### Four-Way and Six-Way Sockets

- Durable zinc die cast housings
- Solid brass split pins
- Locking system on door works with plug to ensure proper hook-up and prevent unintentional disconnections
- Optional protector boot keeps terminals free of moisture and contaminants - sold separately

| Part # | Description                  |
|--------|------------------------------|
| 055052 | Six-way socket               |
| 055056 | Four-way socket              |
| 090217 | Mounting bracket             |
| 090218 | Terminal protector boot      |
| 055053 | Replacement six-way interior |

**NOTE: Part numbers listed in RED are NEW!**

## ELECTRICAL CABLE



### Battery and Starter Cable

- Durable thermoplastic outer jacket keeps cable flexible at low temperatures and resists abrasion, ozone, oil and road salts
- Soft annealed stranded copper
- Cable meets SAE J1127 Type SGT requirements

#### Red Jacketed

| Part #   | Coil Length | Wire Gauge |
|----------|-------------|------------|
| 058033   | 25'         | 6          |
| 058033-7 | 100'        | 6          |
| 058035   | 25'         | 4          |
| 058035-7 | 100'        | 4          |
| 058037   | 25'         | 2          |
| 058037-7 | 100'        | 2          |
| 058039   | 25'         | 1          |
| 058039-7 | 100'        | 1          |
| 058241   | 25'         | 1/0        |
| 058241-7 | 100'        | 1/0        |
| 058243   | 25'         | 2/0        |
| 058243-7 | 100'        | 2/0        |
| 058245   | 25'         | 3/0        |
| 058247   | 25'         | 4/0        |

#### Black Jacketed

| Part #   | Coil Length | Wire Gauge |
|----------|-------------|------------|
| 058233   | 25'         | 6          |
| 058233-7 | 100'        | 6          |
| 058235   | 25'         | 4          |
| 058235-7 | 100'        | 4          |
| 058237   | 25'         | 2          |
| 058237-7 | 100'        | 2          |
| 058239   | 25'         | 1          |
| 058239-7 | 100'        | 1          |
| 058041   | 25'         | 1/0        |
| 058041-7 | 100'        | 1/0        |
| 058043   | 25'         | 2/0        |
| 058043-7 | 100'        | 2/0        |
| 058045   | 25'         | 3/0        |
| 058047   | 25'         | 4/0        |

NOTE: Battery terminals and lugs sold separately (see pages E10-12)

### Multiple Conductor Cable

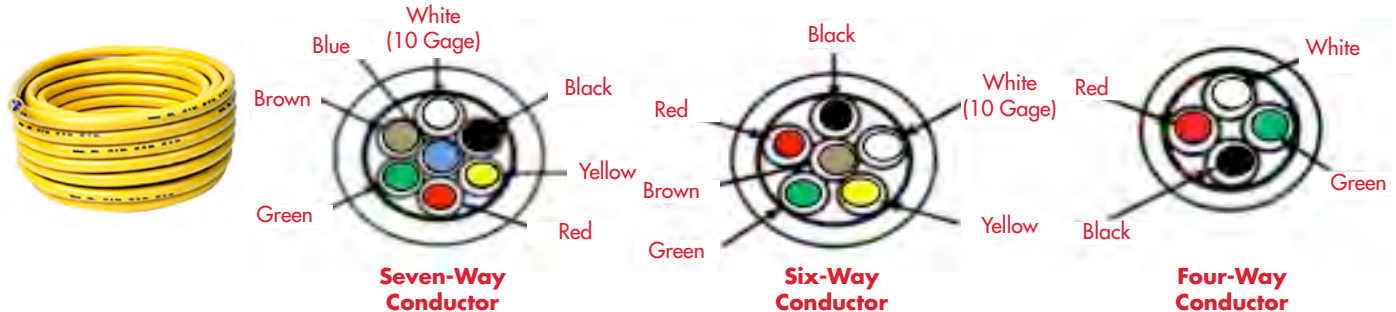

- ABS cable meets SAE J2394 June 1998 Type F requirements

#### ADA Color Code Chart

|        |                                         |
|--------|-----------------------------------------|
| White  | Ground return to towing vehicle         |
| Black  | ICC required marker and clearance light |
| Yellow | Left-hand directional signal            |
| Red    | Stoplights                              |
| Green  | Right-hand directional signal           |
| Brown  | Tall lamps, 3-bar marker lamps          |
| Blue   | Auxiliary                               |

| Part #   | Jacket Color | Coil Length | Conductor | Gauge           |
|----------|--------------|-------------|-----------|-----------------|
| 050019   | Black        | 100'        | Seven     | 6/12, 1/10      |
| 050019-7 | Black        | 500'        | Seven     | 6/12, 1/10      |
| 050042   | Black        | 100'        | Seven     | 14              |
| 050042-7 | Black        | 500'        | Seven     | 14              |
| 050037   | Green (ABS)  | 100'        | Seven     | 1/8, 2/10, 4/12 |
| 050051   | Yellow (ISO) | 50'         | Seven     | 1/8, 2/10, 4/12 |
| 050052   | Yellow (ISO) | 100'        | Seven     | 1/8, 2/10, 4/12 |
| 050007   | Black        | 100'        | Six       | 14              |
| 050007-7 | Black        | 500'        | Six       | 14              |
| 050001   | Black        | 100'        | Four      | 14              |
| 050001-7 | Black        | 500'        | Four      | 14              |



Call the Velvac Sales Team: **800.783.8871** sales@velvac.com

## BATTERY CABLE



### Battery-to-Battery Crossover Cable

- 2/0 gauge wire
- Molded lead terminals and black neoprene outer jacket

| Part # | Description                 |
|--------|-----------------------------|
| 058212 | 12" Battery crossover cable |



### Ground Strap

- 4 gauge wire
- Molded zinc-plated steel lugs and tin-plated copper stranding
- 7/16" diameter bolt hole

| Part # | Description              |
|--------|--------------------------|
| 058116 | Ground strap (12" - 14") |



### Switch-to-Starter Cable

- 4 gauge wire
- Molded zinc-plated steel lugs and red PVC outer jacket

| Part # | Description                 |
|--------|-----------------------------|
| 058115 | 18" Switch-to-starter cable |



### Battery Cable

- 2/0 gauge wire
- Molded copper lug and lead terminal
- Black PVC outer jacket

| Part # | Description       |
|--------|-------------------|
| 058117 | 12" Battery cable |



### Battery Booster Cables

- Copper stranded, 4 gauge wire
- Rated at 400 amps
- Black PVC outer jacket
- Red and black vinyl coated clamps feature solid copper contacts and heavy springs for positive clamping

| Part # | Description               |
|--------|---------------------------|
| 058152 | 16' Battery booster cable |



### 800A Booster Cable

These heavy duty battery cables are rated at 800 amps and are designed to handle jump starting heavy duty equipment

- Solid copper parrot clamps for increased conductivity
- Tangle proof design
- Braided copper wire remains flexible even in subzero temperatures
- Includes strong plastic storage container to protect cables from damage when not in use

| Part # | Description        |
|--------|--------------------|
| 058151 | 800A Booster cable |

### Stud Top Battery Cable

- 2/0 gauge wire
- Molded tin-plated copper lugs and black PVC outer jacket

| Part # | Color | Description                |
|--------|-------|----------------------------|
| 058118 | Black | 8" Stud top battery cable  |
| 058128 | Red   | 8" Stud top battery cable  |
| 058119 | Black | 12" Stud top battery cable |
| 058129 | Red   | 12" Stud top battery cable |



## BATTERY LUGS

- Fully annealed electrolytic copper construction provides excellent conductivity
- Wire gauge identification marked on lug barrels
- Heat-shrink tubing should be used over all battery terminal connections (see pages E33-E35)

### Standard Battery Lugs

- Unique flared barrel design eliminates wire strand hang-ups
- Unplated
- Crimpable



| Part # | Wire Gauge | Stud Size |
|--------|------------|-----------|
| 056033 | 6          | 1/4"      |
| 058073 | 6          | 5/16"     |
| 058074 | 6          | 3/8"      |
| 056034 | 4          | 1/4"      |
| 058076 | 4          | 5/16"     |
| 058077 | 4          | 3/8"      |
| 058078 | 4          | 1/2"      |
| 058079 | 2          | 5/16"     |
| 056035 | 2          | 3/8"      |
| 058081 | 1          | 5/16"     |
| 056036 | 1          | 3/8"      |

| Part # | Wire Gauge | Stud Size |
|--------|------------|-----------|
| 058082 | 1          | 1/2"      |
| 058083 | 1/0        | 5/16"     |
| 056037 | 1/0        | 3/8"      |
| 056038 | 1/0        | 1/2"      |
| 058084 | 2/0        | 5/16"     |
| 056039 | 2/0        | 3/8"      |
| 056040 | 2/0        | 1/2"      |
| 058086 | 3/0        | 3/8"      |
| 056041 | 3/0        | 1/2"      |
| 058088 | 4/0        | 3/8"      |
| 056042 | 4/0        | 1/2"      |

### Heavy-Duty Battery Lugs

- Tin-plated for corrosion resistance
- Crimpable



| Part # | Wire Gauge | Stud Size |
|--------|------------|-----------|
| 058325 | 1/0        | 3/8"      |
| 058326 | 1/0        | 1/2"      |
| 058327 | 2/0        | 3/8"      |
| 058328 | 2/0        | 1/2"      |

| Part # | Wire Gauge | Stud Size |
|--------|------------|-----------|
| 058329 | 3/0        | 3/8"      |
| 058330 | 3/0        | 1/2"      |
| 058331 | 4/0        | 3/8"      |
| 058332 | 4/0        | 1/2"      |

### Heavy-Duty Flared Lug Maintenance Kit



- Kit includes 50 lugs in ten varieties ranging from 6 to 4/0 gauge with stud sized of 1/4", 3/8" and 1/2"
- Packaged in a durable plastic case with product information shown on inside label for easy identification

| Part # | Description                           |
|--------|---------------------------------------|
| 057002 | Heavy-duty flared lug maintenance kit |

| Part # | Qty | Part # | Qty |
|--------|-----|--------|-----|
| 056033 | 6   | 056038 | 4   |
| 056034 | 6   | 056039 | 4   |
| 056035 | 6   | 056040 | 4   |
| 056036 | 6   | 056041 | 4   |
| 056037 | 6   | 056042 | 4   |

### Flared Butt Connectors

- Seamless construction
- Tin-plated for corrosion resistance



| Part # | Wire Gauge |
|--------|------------|
| 058020 | 1          |
| 058021 | 1/0        |
| 058022 | 2/0        |
| 058023 | 3/0        |
| 058024 | 4/0        |



Call the Velvac Sales Team: **800.783.8871** [sales@velvac.com](mailto:sales@velvac.com)

## BATTERY TERMINALS

### Crimpable or Solderable Battery Terminals

- One-piece, cast copper construction
- Lead-plated for corrosion resistance
- Cable size clearly designated on terminals for correct size selection
- Polarity shown on terminals to avoid mixing positive and negative connections
- Tool die and letter codes permanently marked on terminals to simplify installation with other manufacturers' tools
- Uniform wall thickness assures high reliability when connector is crimped on cable
- Long barrels for added strength and vibration resistance
- Heat-shrink tubing should be used over all battery terminal connections (See page E33)



**Right Angle Barrel Terminals**

| Part # | Wire Gauge               | Polarity |
|--------|--------------------------|----------|
| 057056 | 2/0                      | Positive |
| 057057 | 2/0                      | Negative |
| 058055 | 3/0                      | Positive |
| 058056 | 3/0                      | Negative |
| 058011 | Replacement nut and bolt |          |

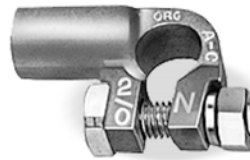

**Right Elbow Terminals**

| Part # | Wire Gauge               | Polarity |
|--------|--------------------------|----------|
| 058052 | 1/0                      | Positive |
| 058051 | 1/0                      | Negative |
| 058005 | 2/0                      | Positive |
| 058006 | 2/0                      | Negative |
| 058009 | 3/0                      | Positive |
| 058010 | 3/0                      | Negative |
| 058011 | Replacement nut and bolt |          |

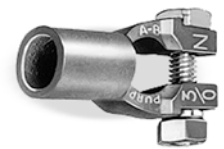

**Straight Barrel Terminals**

| Part # | Wire Gauge               | Polarity  |
|--------|--------------------------|-----------|
| 058050 | 4                        | Universal |
| 057050 | 1                        | Positive  |
| 057051 | 1                        | Negative  |
| 058001 | 1/0                      | Positive  |
| 058002 | 1/0                      | Negative  |
| 057052 | 2/0                      | Positive  |
| 057053 | 2/0                      | Negative  |
| 057054 | 3/0                      | Positive  |
| 057055 | 3/0                      | Negative  |
| 058057 | 4/0                      | Positive  |
| 058058 | 4/0                      | Negative  |
| 058011 | Replacement nut and bolt |           |



**Left Elbow Terminals**

| Part # | Wire Gauge               | Polarity |
|--------|--------------------------|----------|
| 058054 | 1/0                      | Positive |
| 058053 | 1/0                      | Negative |
| 058003 | 2/0                      | Positive |
| 058004 | 2/0                      | Negative |
| 058007 | 3/0                      | Positive |
| 058008 | 3/0                      | Negative |
| 058011 | Replacement nut and bolt |          |



**Marine Terminal**

- 5/16" post

| Part # | Description     |
|--------|-----------------|
| 058019 | Marine terminal |

**Helpful hint:**

Most Velvac terminals are colorcoded according to wire gauge specifications:

- 4 - Green    1/0 - Black
- 2 - Pink    2/0 - Orange
- 1 - Pink    3/0 - Purple
- 4/0 - Yellow

## BATTERY TERMINALS

### ECO-MAX Battery Terminals

- ECO-MAX is the first environmentally friendly, 100% copper battery terminal
- The post top design is manufactured with the highest quality C11000 ETP (Electrolytic Tough Pitch) copper and is completely lead free
- RoHS compliant and therefore exempt from CA Proposition 65 requirements
- C11000 ETP copper battery terminals provide the highest conductivity rating compared to any competing copper design
- Maximum electrical conductivity is 101% IACS at 68°F. Typical designs fall at 20% and 32% IACS at 68°F
- Tin plated for corrosion resistance
- Provided with nut and bolt installed
- Has a beveled barrel for facilitating cable insertion
- Color-coded for polarity identification and color and die coded for crimp settings
- Exceeds SAE Standard J-1811



ECO-Max right elbow



ECO-Max left elbow



ECO-Max flag



ECO-Max straight

| Part # | Cable Gauge | Gage ID Color | Polarity  | Terminal Style |
|--------|-------------|---------------|-----------|----------------|
| 058416 | 4           | Gray          | Negative  | Straight       |
| 058417 | 4           | Gray          | Positive  | Straight       |
| 058418 | 4           | Gray          | Universal | Straight       |
| 058419 | 1-2         | Pink          | Negative  | Straight       |
| 058420 | 1-2         | Pink          | Positive  | Straight       |
| 058421 | 1/0         | Black         | Negative  | Straight       |
| 058422 | 1/0         | Black         | Positive  | Straight       |
| 058423 | 2/0         | Orange        | Negative  | Straight       |
| 058424 | 2/0         | Orange        | Positive  | Straight       |
| 058425 | 3/0         | Purple        | Negative  | Straight       |
| 058426 | 3/0         | Purple        | Positive  | Straight       |
| 058427 | 4/0         | Yellow        | Negative  | Straight       |
| 058428 | 4/0         | Yellow        | Positive  | Straight       |
| 058445 | 1/0         | Black         | Negative  | Flag           |
| 058446 | 1/0         | Black         | Positive  | Flag           |
| 058447 | 2/0         | Orange        | Negative  | Flag           |
| 058448 | 2/0         | Orange        | Positive  | Flag           |
| 058449 | 3/0         | Purple        | Negative  | Flag           |
| 058450 | 3/0         | Purple        | Positive  | Flag           |
| 058451 | 4/0         | Yellow        | Negative  | Flag           |
| 058452 | 4/0         | Yellow        | Positive  | Flag           |
| 058437 | 1/0         | Black         | Negative  | Left elbow     |
| 058438 | 1/0         | Black         | Positive  | Left elbow     |
| 058439 | 2/0         | Orange        | Negative  | Left elbow     |
| 058440 | 2/0         | Orange        | Positive  | Left elbow     |
| 058441 | 3/0         | Purple        | Negative  | Left elbow     |
| 058442 | 3/0         | Purple        | Positive  | Left elbow     |
| 058443 | 4/0         | Yellow        | Negative  | Left elbow     |
| 058444 | 4/0         | Yellow        | Positive  | Left elbow     |
| 058429 | 1/0         | Black         | Negative  | Right elbow    |
| 058430 | 1/0         | Black         | Positive  | Right elbow    |
| 058431 | 2/0         | Orange        | Negative  | Right elbow    |
| 058432 | 2/0         | Orange        | Positive  | Right elbow    |
| 058433 | 3/0         | Purple        | Negative  | Right elbow    |
| 058434 | 3/0         | Purple        | Positive  | Right elbow    |
| 058435 | 4/0         | Yellow        | Negative  | Right elbow    |
| 058436 | 4/0         | Yellow        | Positive  | Right elbow    |



Call the Velvac Sales Team: **800.783.8871** [sales@velvac.com](mailto:sales@velvac.com)



## BATTERY TERMINALS

### Battery Stud Nut

- Stainless steel construction



| Part # | Description           |
|--------|-----------------------|
| 058068 | 3/8" Battery stud nut |

### Heavy-Duty Terminal

- For 1" 4/0 gauge wire



| Part # | Description         |
|--------|---------------------|
| 058016 | Heavy duty terminal |

### Crimpable or Solderable Terminals for Stud Top Batteries



Base terminal

| Part # | Wire Gauge | Polarity  |
|--------|------------|-----------|
| 058090 | 1/0        | Universal |
| 058091 | 2/0        | Universal |
| 058092 | 3/0        | Universal |
| 058093 | 4/0        | Universal |



Flag terminal

| Part # | Wire Gauge | Polarity  |
|--------|------------|-----------|
| 058251 | 1/0        | Universal |
| 058252 | 2/0        | Universal |
| 058253 | 3/0        | Universal |
| 058254 | 4/0        | Universal |

### Medium-Duty Terminal

- For 6 to 2 gauge wire



| Part # | Description          |
|--------|----------------------|
| 058012 | Medium-duty terminal |

### Three-Way Battery Terminals

- For 1 to 2/0 gauge wire
- Lead construction with zinc-plated steel bolts and nuts
- Positive and negative terminals included



| Part # | Description                 |
|--------|-----------------------------|
| 058071 | Three-way battery terminals |

### OEM Battery Bolt

- Recessed groove permits attachment of battery charger or jumper cables
- Zinc-plated steel construction
- 3/8" - 16" UNC
- 1-3/16" long



| Part # | Description      |
|--------|------------------|
| 058296 | OEM battery bolt |



### Battery Post and Terminal Cleaner

| Part # | Description                       |
|--------|-----------------------------------|
| 058046 | Battery post and terminal cleaner |

### Side Post Terminal

- For 6 to 2 gauge wire



| Part # | Description        |
|--------|--------------------|
| 058013 | Side post terminal |

### Stud Mount To-Post Mount Conversion Terminals

- All lead construction
- Both positive and negative posts included



| Part # | Description                                   |
|--------|-----------------------------------------------|
| 058017 | Stud mount-to-post mount conversion terminals |

### Protective Battery Washers

- Washers seal out acid fumes protecting terminals from corrosion
- Packaged in convenient plastic screw top jars



| Part # | Description                        |
|--------|------------------------------------|
| 058094 | Protective battery washers - red   |
| 058095 | Protective battery washers - black |

## SWITCHES AND SOLENOIDS



### Indicator Lights

- Chrome housing and nylon base
- LED's rated for 15mA at 12 VDC
- 100,000 hours estimated bulb life expectancy
- Temperature rating up to +185°F (85°C)
- 20 AWG lead wires
- 7/16" diameter recommended mounting hole

| Part # | Color |
|--------|-------|
| 090213 | Red   |
| 090214 | Amber |
| 090215 | Green |



### Wiper Control Switch

- Operating temperature: -20° to +160°F
- Washer motor: 6 amps max. current draw
- Nominal voltage: 12 VDC (9 VDC min., 16VDC max.)
- Terminal configuration: 8 pin amp connector-mates with amp connector 770579-1 and 171639-1 socket terminals (not included and not available from Velvac)
- Integrates multi-speed wiper and washer functions into a single dashboard device
- Backlit for easy identification
- Fits standard 22 mm x 44 mm opening

| Part # | Description          |
|--------|----------------------|
| 090120 | Wiper control switch |



### Toggle Accessories

- Protect toggle switches from moisture, dust and dirt
- UV-resistant, black silicon construction
- Built-in hex nut base screws on to most Velvac toggle switches
- Rated for -40° to +350°F (+180°C)

| Part # | Description |
|--------|-------------|
| 090210 | Full boot   |
| 090211 | Half boot   |



### License / Utility Lights

- 12 VDC
- Weather-proof gasket
- 31" wire lead with .250" male disconnect
- 89 bulb
- Fits 1-1/4" mounting hole

| Part # | Description                      |
|--------|----------------------------------|
| 090173 | Twist-in license / utility light |

- Fits GM/GMC trucks with step bumper
- 12 VDC
- 7-7/8" wire lead with protective boot where wire attaches to light and self-grounding single post adapter
- 67 bulb
- Mounting holes approx. 2-11/16" on center



| Part # | Description                          |
|--------|--------------------------------------|
| 090174 | Bumper mount license / utility light |

- Rugged, spring-loaded design provides protection against accident actuation
- Mounting hole accepts all standard Velvac toggles with 15/32" mounting stems



| Part # | Description  |
|--------|--------------|
| 090212 | Safety cover |

### Battery Disconnect Switch

- Two position: on/off
- Continuous rating 180 amps (max)
- Momentary rating 1000 amps (max)
- Momentary use only: 15 sec. on/5 min. off
- Heavy gauge, plated steel casing
- Die cast lever
- 3/4" diameter mounting stem
- UL approved for 6 to 36 VDC



090104



090233, 090234

| Part #  | Description                                                   |
|---------|---------------------------------------------------------------|
| 090104* | Battery disconnect switch SPST                                |
| 090233  | Battery disconnect switch DPST                                |
| 090234  | Battery disconnect switch DPST w/ anti-rotation indexing post |

\*Not UL approved

### Push Button Switch

- Rated for 50 amps at 12VDC
- 5/8" - 32 UNS mounting bushing for panels up to 1/2" thick
- Push for momentary-on action
- Die cast with silver/copper contacts and two screw terminals
- Dust and moisture resistant
- Boot nut included



| Part # | Description                  |
|--------|------------------------------|
| 090190 | Momentary push button switch |



Call the Velvac Sales Team: **800.783.8871** sales@velvac.com

## SWITCHES AND SOLENOIDS

### Heavy Duty Toggle Switches

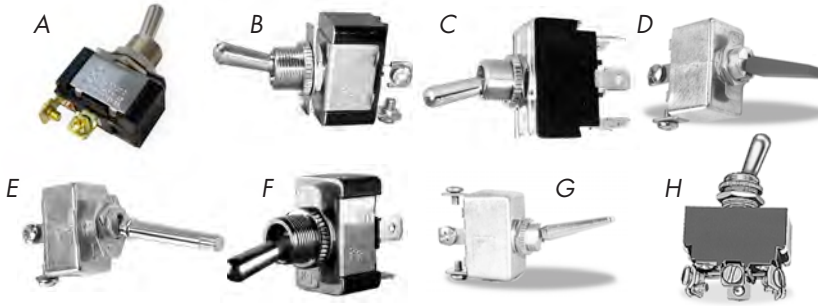

- Frame and support constructed from steel with zinc chromate, brass terminals
- Neoprene-sealed toggles are moisture and dust resistant

- Fully assembled with locating ring/tongue nut (and On/Off faceplate on single pole switches only)
- 1/2" diameter recommended mounting hole- all toggles must be installed with provided hex nut behind panel to prevent damage during installation

| Photo           | Part # | Poles | Amp | VDC     | Circuitry         | Terminals             | Miscellaneous        |
|-----------------|--------|-------|-----|---------|-------------------|-----------------------|----------------------|
| Single Pole     |        |       |     |         |                   |                       |                      |
| B               | 090176 | SPST  | 21A | 14      | On / Off          | (2) 0.250" Flat blade | -                    |
| A               | 090177 | SPST  | 21A | 14      | On / Off          | (2) Screw             | -                    |
| B               | 090199 | SPDT  | 21A | 14      | On / Off / On     | (3) 0.250" Flat blade | -                    |
| A               | 090200 | SPDT  | 21A | 14      | On / Off / On     | (3) Screw             | -                    |
| A               | 090201 | SPDT  | 21A | 14      | (On) / Off / (On) | (3) Screw             | -                    |
| A               | 090202 | SPDT  | 21A | 14      | On / Off / (On)   | (3) Screw             | -                    |
| F               | 090191 | SPST  | 30A | 12      | On / Off          | (3) 0.250" Flat blade | Red LED handle****   |
| F               | 090192 | SPST  | 30A | 12      | On / Off          | (3) 0.250" Flat blade | Green LED handle**** |
| F               | 090193 | SPST  | 30A | 12      | On / Off          | (3) 0.250" Flat blade | Blue LED handle****  |
| D               | 090186 | SPST  | 50A | 12      | On / Off          | (2) Screw             | Black handle**       |
| D               | 090187 | SPST  | 50A | 12      | On / Off          | (2) Screw             | Red handle**         |
| D               | 090188 | SPST  | 50A | 12      | On / Off          | (2) Screw             | Chrome handle**      |
| E               | 090189 | SPST  | 50A | 6/12/24 | On / Off          | (2) Screw             | 1-5/8" Chrome handle |
| G               | 090184 | SPDT  | 50A | 6/12/24 | On / Off / On     | (3) Screw             | Chrome plated***     |
| -               | 090040 | SPDT  | 50A | 6-24    | On / On           | (3) Screw             |                      |
| -               | 090043 | SPDT  | 50A | 6-24    | (On) / Off / (On) | (3) Screw             |                      |
| Double Pole     |        |       |     |         |                   |                       |                      |
| A               | 090203 | DPST  | 21A | 14      | On / Off          | (4) Screw             |                      |
| C               | 090204 | DPST  | 21A | 14      | On / Off          | (4) 0.250" Flat blade |                      |
| H               | 090048 | DPDT  | 21A | 14      | On / On           | (6) Screw             |                      |
| C               | 090205 | DPDT  | 21A | 14      | On / On           | (6) 0.250" Flat blade |                      |
| C               | 090206 | DPDT  | 21A | 14      | On / Off / On     | (6) 0.250" Flat blade |                      |
| A               | 090208 | DPDT  | 21A | 14      | (On) / Off / (On) | (6) Screw             |                      |
| C               | 090209 | DPDT  | 21A | 14      | (On) / Off / (On) | (6) 0.250" Flat blade |                      |
| "O" Ring Sealed |        |       |     |         |                   |                       |                      |
| A               | 090179 | SPST  | 21A | 14      | On / Off          | (2) Screw             |                      |
| A               | 090194 | SPST  | 21A | 14      | (On) / Off        | (2) Screw             |                      |
| A               | 090196 | SPDT  | 21A | 14      | On / On           | (3) Screw             |                      |
| A               | 090197 | SPDT  | 21A | 14      | On / Off / On     | (3) Screw             |                      |
| B               | 090198 | SPDT  | 21A | 14      | On / Off / On     | (3) 0.250" Flat blade |                      |
| A               | 090207 | DPDT  | 21A | 14      | On / Off / On     | (6) Screw             |                      |

( ) indicates  
MOMENTARY  
ACTION

\*\* Die cast housing with silver-plated contacts, heavy copper terminals, stems measure 15/32" dia. X 15/32" long

\*\*\* Paddle type handle

\*\*\*\*Black toggle handles tipped with LED, min draw requirements for LED is 20 mA at 12 VDC

## SWITCHES AND SOLENOIDS

### Two-Speed Axle Switch and Automatic Terminal Block Switch

- Terminal block switch used in conjunction with axle switch to control two-speed electric axle shift
- Axle switch has red knob and uses (3) .156" female snap plugs (see page E25)



Terminal block switch

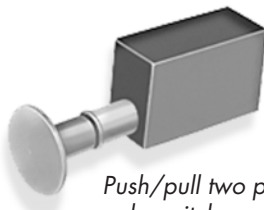

Push/pull two position axle switch

| Part # | Description                     |
|--------|---------------------------------|
| 090078 | Two-speed axle switch           |
| 090079 | Automatic terminal block switch |



090225



090085

### Three Wire Connector

- Use as a flasher socket or any other three wire application (see page E19 for flashers)
- 18 gauge 12" leads

| Part # | Description          |
|--------|----------------------|
| 090225 | Three wire connector |
| 090085 | Three wire socket    |

## Dimmer Switches and Socket Assemblies



### Application

- Chrysler floor mounted (1841895, 1881938, 2097628, 2291202, CH-2437)  
Year: 1959-83
- Dodge Trucks  
Year: 1959-79
- AMC (3156124, 3160926)  
Year: 1959-83

| Part # | Description                   |
|--------|-------------------------------|
| 090073 | Dimmer switch                 |
| 090083 | Dimmer switch socket assembly |



### Application

- All Ford floor mounted  
Year: 1959-83 (COTF-130A024A; COTZ-13A024A, SW-263)

| Part # | Description                   |
|--------|-------------------------------|
| 090081 | Dimmer switch                 |
| 090083 | Dimmer switch socket assembly |



### Application

- Vehicles without auto dimmer
- All GM floor mounted (1997028, 1997037, 3841892, D808)  
Year: 1961-83
- All Jeep floor mounted (5461816)  
Year: 1974-82

| Part # | Description                   |
|--------|-------------------------------|
| 090080 | Dimmer switch                 |
| 090082 | Dimmer switch socket assembly |

## Universal Solenoids

- Designed to operate a minimum of 50,000 cycles
- 125 amps at 12 VDC
- Continuous voltage
- SPST, normally Off, one circuit Off/On
- 5/16" side studs, #10 top stud/s
- Both include hardware

| Part # | Description                   |
|--------|-------------------------------|
| 090054 | Three stud universal solenoid |
| 090056 | Four stud universal solenoid  |



Call the Velvac Sales Team: **800.783.8871** sales@velvac.com

## SWITCHES AND SOLENOIDS

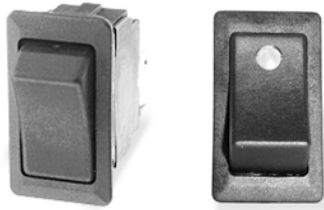

Standard

Lighted

- 21 amps at 14 VDC
- .830" x 1.450" recommended mounting hole
- Universal, snap-in design allows for easy installation
- Moisture and dust resistant
- Packaging for all new switches displays easily on pegboards or wire display rack (see Retail section)

### Full Size Rocker Switches (Standard)

| Part # | Poles | Circuitry       | Terminals            |
|--------|-------|-----------------|----------------------|
| 090109 | SPST  | On / Off        | (2) .250" Flat blade |
| 090150 | SPST  | (On) / Off      | (2) .250" Flat blade |
| 090147 | SPST  | On / (Off)      | (2) Screw            |
| 090153 | SPDT  | On / (On)       | (3) Screw            |
| 090111 | DPST  | On / Off        | (4) .250" Flat blade |
| 090149 | DPST  | On / (Off)      | (4) Screw            |
| 090136 | DPDT  | On / On         | (6) .250" Flat blade |
| 090110 | DPDT  | On / Off / On   | (6) .250" Flat blade |
| 090158 | DPDT  | On / Off / (On) | (6) .250" Flat blade |

( ) indicates MOMENTARY ACTION

### Accessories

| Part # | Description    |
|--------|----------------|
| 090219 | End bracket    |
| 090220 | Middle bracket |
| 090221 | Single bracket |
| 090222 | Panel plug     |



Accessories

### Full Size Rocker Switches (Lighted)

| Part # | Poles | Circuitry | Terminals            | Light Color |
|--------|-------|-----------|----------------------|-------------|
| 090123 | SPST  | On / Off  | (3) Screw            | Red         |
| 090124 | SPST  | On / Off  | (3) Screw            | Green       |
| 090125 | SPST  | On / Off  | (3) Screw            | Amber       |
| 090128 | SPST  | On / Off  | (3) .250" Flat blade | Red         |

### On / Off Round Rocker Switch

- Single pole switches rated for 10 amps at 12 VDC
- 12 VDC illumination voltage
- Snap-in mounting design for easy installation in .79" diameter mounting hole
- (3) .187" flat blade terminals
- Two positions (SPST) with two .187" silver-plated brass blade terminals
- On/Off designation permanently etched on rocker switch
- Snap-in mounting design for easy installation in .79" diameter mounting hole

| Part # | Poles | Light Color |
|--------|-------|-------------|
| 090167 | SPST  | Red         |
| 090168 | SPST  | Amber       |
| 090169 | SPST  | Green       |

| Part # | Description                              |
|--------|------------------------------------------|
| 090166 | Round rocker switch with On/Off markings |



090166

## SWITCHES AND SOLENOIDS



Keys included

### Universal Ignition Switch

- Single throw ignition
- 6 to 24 VDC
- 3/4" diameter mounting stem with two terminals

| Part # | Description               |
|--------|---------------------------|
| 090076 | Universal ignition switch |

### Push / Pull Switches

- Rated for 15 amps at 12 VDC, 25 amps at 6 VDC
- Heavy-duty, two position (SPST) push/pull switch with two brass screw terminals
- Brass and chrome construction
- 3-1/8" overall length x 7/8" wide
- Mounting stem measures 3/8" in diameter and 1-1/4" long
- Accommodates 1" panel with stainless steel springs

| Part # | Description        |
|--------|--------------------|
| 090181 | Push / pull switch |



- Rated for 75 amps at 6 to 28 VDC
- Heavy-duty, two position (SPST) push/pull switch with two brass screw terminals
- Chrome-plated metal knob
- Mounting stem measures 15/32" in diameter and 5/8" long

| Part # | Description        |
|--------|--------------------|
| 090180 | Push / pull switch |

## RELAYS

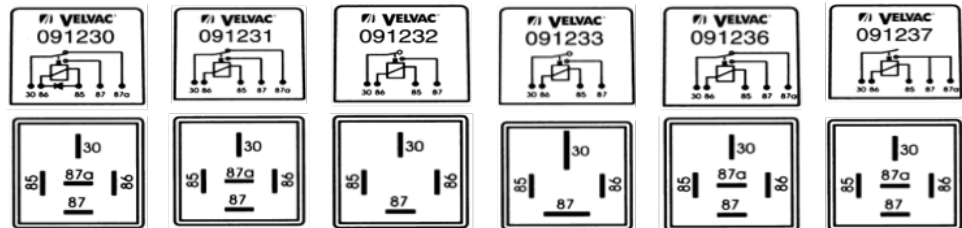

### Heavy-Duty Relay Kit

- Ideal for powering accessories with high voltage draws such as fog lights, power windows and fans
- Help ensure maximum power available to accessories and lights
- Kit includes heavy-duty relay, switch, switch mounting plate, 20' of 14 gauge wire and terminals

| Part #                                                                                                                                              | Description          | Voltage | Amp | Terminals | Mounting Tab |
|-----------------------------------------------------------------------------------------------------------------------------------------------------|----------------------|---------|-----|-----------|--------------|
| 091230                                                                                                                                              | Relay with diode     | 12      | 40  | 5         | No           |
| Application for 091230: Diode eliminates voltage spikes that can occur when the relay is shut off; it can be used to run up to 30 amps continuously |                      |         |     |           |              |
| 091231                                                                                                                                              | Relay                | 12      | 40  | 5         | Yes          |
| 091232                                                                                                                                              | Relay                | 12      | 40  | 4         | Yes          |
| Application for 091232: Used to run up to 30 amps continuously                                                                                      |                      |         |     |           |              |
| 091236                                                                                                                                              | Relay                | 24      | 20  | 5         | Yes          |
| 091237                                                                                                                                              | Dual relay           | 12      | 40  | 5         | Yes          |
| Application for 091237: Controls two separate 20 amp accessories; also used as a single 40 amp relay                                                |                      |         |     |           |              |
| 091233                                                                                                                                              | Heavy-duty relay     | 12      | 70  | 4         | Yes          |
| Application for 091233: Ideal for controlling larger devices; can run up to 50 amps continuously                                                    |                      |         |     |           |              |
| 091235                                                                                                                                              | Heavy-duty relay kit | 12      | 70  | 4         | Yes          |
| In addition to standard package of one, all relays may also be ordered in bulk shop packs of 25 by adding a -7 to the part number shown             |                      |         |     |           |              |



Call the Velvac Sales Team: **800.783.8871** [sales@velvac.com](mailto:sales@velvac.com)

## SIGNAL FLASHERS

### Electro-Mechanical and Electronic Flashers

- Designed and tested to perform in excess of one million cycles
- Audible signal indicates that flasher is activated
- Non-polarity sensitive
- 12 VDC operating range



Style A  
electro-mechanical



Style B  
electronic



### Solid State LED Flasher

- 6 amp flasher provides constant flash rate of 90 FPM for new LED lights
- Compact size fits standard two terminal flasher footprint - includes remote mount 36" long ground wire

| Part # | Description             |
|--------|-------------------------|
| 091225 | Solid state LED flasher |



| Part #                                                                                                       | Style | Terminals | Color       | Lamp Rating      | Flash Rate FPM | Amp Rating |
|--------------------------------------------------------------------------------------------------------------|-------|-----------|-------------|------------------|----------------|------------|
| 091215                                                                                                       | A     | 2         | Clear smoke | 1-10             | 60-120         | 25         |
| 091216                                                                                                       | A     | 3         | Clear smoke | 1-10             | 60-120         | 25         |
| Applications for 091216: Fits most American cars, older import cars and light trucks                         |       |           |             |                  |                |            |
| 091208                                                                                                       | B     | 2         | Red         | 2-12             | 70-120         | 25         |
| 091209                                                                                                       | B     | 3         | Clear smoke | 2-12             | 70-120         | 25         |
| Applications for 091209: Straight truck, single trailer, high flasher usage                                  |       |           |             |                  |                |            |
| 091210                                                                                                       | B     | 2         | Clear smoke | 2-16             | 70-120         | 35         |
| 091211                                                                                                       | B     | 3         | Clear smoke | 2-16             | 70-120         | 35         |
| Applications for 091211: Straight truck, single or double trailer or any vehicle with high flasher usage     |       |           |             |                  |                |            |
| 091212                                                                                                       | B     | 2         | Clear smoke | 2-20             | 70-120         | 45         |
| 091213                                                                                                       | B     | 3         | Black       | 2-20             | 70-120         | 45         |
| Applications for 091213: Severe duty, double or triple trailers or vehicles where flasher is frequently used |       |           |             |                  |                |            |
| 091214                                                                                                       | B     | 3         | Clear smoke | 10 Lamps / Side* | 60-120         | 25         |
| Application for 091214: Alternating "Wig-Wag" headlight application for emergency vehicles and school buses  |       |           |             |                  |                |            |

\*10 lamps per side (1156, 1157) or 4 (H4651) sealed beams  
See page E16 for three wire flasher socket Part No. 090225

### Thermal Flashers

- Flash two to three lamps for turn signals, two to six lamps for hazard warning

| Part # | Description    |
|--------|----------------|
| 091203 | Two terminal   |
| 091204 | Three terminal |



### Heavy-Duty Flashers

- 12 lamp and 25 amp rating
- Last five times longer than thermal flashers
- Three-terminal flasher for vehicles equipped with flashing dash lights
- Operate at voltages as low as 7 VDC

| Part # | Description    |
|--------|----------------|
| 091201 | Two terminal   |
| 091202 | Three terminal |

#### NOTES

A thermal flasher (fixed load) is NOT recommended for use when a trailer is connected to a car or truck. A heavy-duty flasher (variable load) is recommended duty for this type of application

Dash "- xx" indicates package quantity

## CIRCUIT BREAKERS

### Standard Circuit Breakers



- Copper colored battery stud provides easy identification
- "Waterproof" sealant and insert molded studs on waterproof breakers make them suitable for marine applications and trailer connections
- 12 VDC
- Meets applicable SAE J553 requirements
- Each circuit breaker includes two #10-32 nuts

| Part # w/o mounting strap | Part # w/ mounting Strap | Amp |
|---------------------------|--------------------------|-----|
| 091011                    | 091051                   | 10  |
| 091015                    | 091052                   | 15  |
| 091020                    | 091053                   | 20  |
| 091025                    | 091054                   | 25  |
| 091030                    | 091055                   | 30  |
| 091040                    | 091056                   | 40  |
| 091050                    | 091057                   | 50  |

### ATM and MAXI™ Circuit Breaker



- Replacement for ATM/MINI® and MAXI™ blade type fuses
- 12 VDC, rated 5 to 30 amps
- -40°F (-40°C) to 185°F (85°C) operating temperature range
- ATM/MINI® Type II Modified Reset type breakers and MAXI™ Type I Automatic Reset type breakers meet applicable SAE J553 requirements

| ATM/Mini® Part # | Maxi™ Part # | Amp |
|------------------|--------------|-----|
| 091500-3         | -            | 5   |
| 091501           | 091510-10    | 10  |
| 091502           | 091511-10    | 15  |
| 091503           | 091512-10    | 20  |
| 091504           | 091513-10    | 25  |
| 091505           | 091514-10    | 30  |

### Fuse Clip Circuit Breakers



- Replacement for 1/4" x 1-1/4" glass fuses
- 12 VDC
- -25°F (-32°C) to 180°F (82°C) operating temperature range
- Type II Modified Reset type breakers meet SAE J553 requirements

| Part # | Amp |
|--------|-----|
| 091080 | 10  |
| 091081 | 15  |
| 091082 | 20  |
| 091083 | 30  |

### High Amp Circuit Breaker



- Type III switchable breaker typically used in auxiliary and accessory circuits for trucks, buses, RVs and marine applications
- Flush mount with sems nut installed
- 30 VDC
- -25°F (-32°C) to 180°F (82°C) operating temperature range
- Measures 2" x 3" overall
- Meets SAE J1625 requirements

| Part # | Description      |
|--------|------------------|
| 091005 | 60 High amp      |
| 091006 | 80 High amp      |
| 091007 | 100 High amp     |
| 091008 | 120 High amp     |
| 091003 | 150 High amp     |
| 091004 | Economic 150 amp |
| 091009 | 200 High amp     |

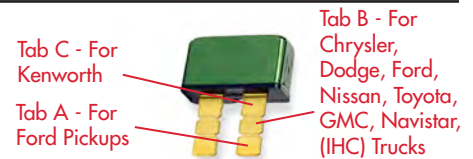

### Universal Snap-off Blade Type Circuit Breakers

- Replacement for ATC/ATO® blade type fuses
- Color-coded for easy identification
- 12 VDC
- -40°F (-40°C) to 185°F (85°C) operating temperature range
- Type I Automatic Reset type breakers meet applicable SAE J553 requirements

| Part # | Amp | Color  |
|--------|-----|--------|
| 091076 | 6   | Silver |
| 091071 | 10  | Red    |
| 091072 | 15  | Blue   |
| 091073 | 20  | Yellow |
| 091074 | 25  | Silver |
| 091075 | 30  | Green  |

### Fuse and Fuse Block

- Isolates faults in equipment such as lift trucks and other battery operated systems
- Silver plated copper link visible through a mica window



| Part # | Description                    |
|--------|--------------------------------|
| 091351 | ANL style fuse, 300 amp        |
| 091350 | Fuse block for ANL style fuses |



Call the Velvac Sales Team: **800.783.8871** sales@velvac.com



## FUSES AND ACCESSORIES

### AGC, AGX and SFE Fuses

| AGC Part # | AGX Part # | SFE Part # | Amp   |
|------------|------------|------------|-------|
| 091131-5   | -          | -          | 1     |
| 091132-5   | -          | -          | 2     |
| 091133-5   | -          | -          | 3     |
| 091135-5   | -          | -          | 5     |
| 091137-5   | -          | -          | 7 1/2 |
| 091140-5   | -          | -          | 10    |
| 091141-5   | -          | -          | 15    |
| 091142-5   | See below  | 091171-5   | 20    |
| 091143-5   | -          | -          | 25    |
| 091144-5   | See below  | 091172-5   | 30    |

### AGX Fuse Assortments

| Part # | Description              |
|--------|--------------------------|
| 091251 | AGX 20-30 amp assortment |

Includes (2) 20 amp, (2) 25 amp and (2) 30 amp AGX fuses

#### NOTES

Dash "- xx" indicates package quantity

\* In addition to display card packaging, fuses may also be ordered in bulk packs of 25 by adding a -25 to the part number



### Electrical Junction Box

- Measures 6-9/16" x 3-1/4"
- Includes all fasteners and grommets

| Part # | Description             |
|--------|-------------------------|
| 055060 | Electrical junction box |



AGC 1-30 / SFE 20, 30  
AGC 20, 30



ATC/  
ATO®



ATM/  
MINI®



MAXI™

### ATC/ATO®, ATM/MINI® and MAXI™ Fuses

| ATC/ATO®  | ATM/MINI® | MAXI™    | Amp   | Color   |
|-----------|-----------|----------|-------|---------|
| -         | 091300-5  | -        | 2     | Gray    |
| 091173-5  | 091301-5  | -        | 3     | Violet  |
| 091174-5  | 091302-5  | -        | 4     | Pink    |
| 091175-5  | 091303-5  | -        | 5     | Tan     |
| 091177-5  | 091304-5  | -        | 7-1/2 | Brown   |
| 091180-5* | 091305-5* | -        | 10    | Red     |
| 091181-5* | 091306-5* | -        | 15    | Blue    |
| 091182-5  | 091307-5* | 091400-5 | 20    | Yellow  |
| 091183-5* | 091308-5* | -        | 25    | Clear   |
| 091184-5* | 091309-5* | 091401-5 | 30    | Green   |
| -         | -         | 091402-5 | 40    | Orange  |
| -         | -         | 091403-5 | 50    | Red     |
| -         | -         | 091404-5 | 60    | Blue    |
| -         | -         | 091406-3 | 80    | Natural |



### ATC/ATO® Fuse Panel

- Accepts blade-type fuses, auto or manual reset circuit breakers
- 6 circuits, 30 amps per circuit with quick connect terminals
- No top cover needed; recessed fuse contacts provide touch-safe protection
- Black thermoplastic construction - temperature rating of -20°F (29°C) to +150°F (65°C)
- Fuses/circuit breakers sold separately

| Part # | Description         |
|--------|---------------------|
| 091427 | ATC/ATO® fuse panel |



### ATC/ATO® Fuse Assortment with Combination Fuse Tester/Puller

- Assortment contains 42 ATC fuses - seven each of the six most popular fuses from 5 to 30 amps
- Combination fuse tester/puller tests and removes blade type and a variety of glass fuses
- Reclosable heavy-duty display pkg.

| Part # | Description                 |
|--------|-----------------------------|
| 091254 | Fuse assortment with tester |

## FUSES AND ACCESSORIES



### Universal In-Line Fuse Holder

- Universal nylon twist-lock fuse holder for 1/4" x 1-1/4" AGC, AGA, AGW, AGX and SFE fuses
- 20 amp maximum load
- 14 gauge lead wire
- Fuse sold separately

| Part # | Description                   |
|--------|-------------------------------|
| 091188 | Universal in-line fuse holder |



### Heavy Duty In-Line Fuse Holder

- Nylon heavy duty fuse holder for 1/4" x 1-1/4" glass fuses
- 30 amp maximum load
- 12 gauge lead wire
- Includes one 30 amp AGC fuse installed

| Part # | Description                                       |
|--------|---------------------------------------------------|
| 091189 | Heavy duty in-line fuse holder w/ 30 amp AGC fuse |



### Heavy Duty ATC/ATO® In-Line Fuse Holders

- Fits blade type fuses from 3 to 30 amps
- 12 gauge lead wire
- Part No. 091130 includes one 30 amp ATC fuse

| Part # | Description                                                |
|--------|------------------------------------------------------------|
| 091190 | Heavy duty ATC/ATO® in-line fuse holder w/o fuse           |
| 091130 | Heavy duty ATC/ATO® in-line fuse holder w/ 30 amp ATC Fuse |



### ATM/MINI® In-Line Fuse Holder with Cover

- Fits ATM/MINI® blade type fuses from 2 to 30 amps
- 12 gauge lead wire
- Cover provides protection from harsh under-the-hood environmental elements
- Fuse sold separately

| Part # | Description                              |
|--------|------------------------------------------|
| 091426 | ATM/MINI® In-line fuse holder with cover |



### MAXI™ In-Line Fuse Holder with Cover

- Fits MAXI blade type fuses from 20 to 60 amps
- 8 gauge lead wire
- Cover provides protection from harsh under-the-hood environmental elements
- Fuse sold separately

| Part # | Description                         |
|--------|-------------------------------------|
| 091425 | MAXI In-line fuse holder with cover |



091325

091326

### Add-A-Circuits

- Converts one circuit into two fuse protected circuits; plugs into fuse-block and accepts two fuses to provide protection for the existing circuit and the add-on circuit
- 10 amp maximum circuit load
- Fuse sold separately

| Part # | Description             |
|--------|-------------------------|
| 091325 | ATM/MINI® Add-a-circuit |
| 091326 | ATC/ATO® Add-a-circuit  |

### Self-Stripping ATC/ATO® Fuse Holder

- For use with ATC/ATO® blade type fuses up to 30 amps
- Easily attaches to wires ranging from 18 to 14 gauge
- Fuse sold separately



| Part # | Description                         |
|--------|-------------------------------------|
| 057003 | Self-stripping ATC/ATO® fuse holder |

In-line fuse holders (except MAXI) and add-a-circuits are display carded to fit on display rack in Retail section



Call the Velvac Sales Team: **800.783.8871** sales@velvac.com

## FUSES AND ACCESSORIES

### Fuse Kits



| Part # | Description                          |
|--------|--------------------------------------|
| 091001 | ATM/MINI® and MAXI fuse kit          |
| 091002 | ATC/ATO®, AGC and ATM/MINI® fuse kit |

- Convenient, pre-packaged fuse assortments save time by keeping popular sized fuses close at hand
- Durable, see-through plastic cases with handy "locator" cards are easy to refill for using over and over
- Multi-functional kits can be displayed on the front counter to attract the impulse sale of single fuses or used as mini storage systems to save time and money by eliminating multiple trips to the shop for additional parts

### ATM/MINI® and MAXI™ Fuse Kit

| ATM/MINI® | MAXI™  | Qty | Amp   |
|-----------|--------|-----|-------|
| 091300    | -      | 10  | 2     |
| 091301    | -      | 10  | 3     |
| 091303    | -      | 10  | 5     |
| 091304    | -      | 10  | 7-1/2 |
| 091305    | -      | 10  | 10    |
| 091306    | -      | 10  | 15    |
| 091307    | -      | 10  | 20    |
| 091308    | -      | 10  | 25    |
| 091309    | -      | 10  | 30    |
| -         | 091400 | 5   | 20    |
| -         | 091401 | 5   | 30    |
| -         | 091402 | 5   | 40    |
| -         | 091403 | 5   | 50    |
| -         | 091404 | 5   | 60    |
| -         | 091406 | 3   | 80    |

### ATC/ATO®, AGC and ATM/MINI® Fuse Kit

| AGC    | ATM/MINI® | AGC    | Qty | Amp |
|--------|-----------|--------|-----|-----|
| 091133 | -         | -      | 10  | 3   |
| 091135 | -         | -      | 10  | 5   |
| 091140 | -         | -      | 10  | 10  |
| 091141 | -         | -      | 10  | 15  |
| 091142 | -         | -      | 10  | 20  |
| 091144 | -         | -      | 10  | 30  |
| -      | 091303    | -      | 10  | 5   |
| -      | 091305    | -      | 10  | 10  |
| -      | 091306    | -      | 10  | 15  |
| -      | 091307    | -      | 10  | 20  |
| -      | 091308    | -      | 10  | 25  |
| -      | 091309    | -      | 10  | 30  |
| -      | -         | 091175 | 10  | 5   |
| -      | -         | 091180 | 10  | 10  |
| -      | -         | 091181 | 10  | 15  |
| -      | -         | 091182 | 10  | 20  |
| -      | -         | 091183 | 10  | 25  |
| -      | -         | 091184 | 10  | 30  |

#### Did you know...

Federal Motor Carrier Safety Regulation 393.95 requires every bus, truck, truck tractor and a drive-away towaway operation to carry a replacement fuse for each kind and size in the vehicle?

## TERMINALS AND CONNECTORS

### Crimp Terminals and Connectors

- One-piece construction assures maximum electrical conductivity
- Electro bright, tin-plated annealed copper construction for maximum corrosion resistance
- Injection-molded insulation allows a funnel barrel construction for easy installation and ensures a consistent wall thickness for maximum reliability after crimping
- Crimp ridge on each terminal for positive location of crimp tool on terminal barrel means fewer mis-crimps
- Open end terminal design permits easy inspection of wire
- Designed to withstand temps of -40° to +221°F (+105°C)
- Heat-shrink tubing and electrical tape available and sold separately (see pages E32, E33 and E38)



**Velvac offers a wide variety of terminals and connectors. For the same application the following terminals may be available: crimp, crimp and seal, crimp/solder/seal, snap or heatless connectors**

### Crimp and Seal Terminals and Connectors

Simple three step installation reduces wiring time and costs



- Heat-shrink terminals combine color-coded, heat-shrink tubing with one-piece solderless terminals to produce fast, watertight, corrosion resistance cutwire connections
- UL approved
- Improved mechanical performance provides improved pull-out strength and strain relief
- Designed to withstand temperatures of -67°F (-55°C) to +221°F (+150°C)
- Electrical tape and heat gun available and sold separately (see page E38)
- Resist abrasion, scoring, cut-through and the effects of long term aging



STEP 1: STRIP copper wire

STEP 2: INSERT wire into sealing gel. Rotate to coat wire

STEP 3: RE-INSERT wire until insulation contacts connector. CRIMP connector



### Crimp/Solder/Seal Terminals and Connectors

- Pre-inserted solder terminals reduce installation time and increase efficiency, while achieving the benefits of both crimp terminals and solder terminals
- Each terminal contains solder for increased strength and conductivity
- Adhesive-lined heat shrink tubing seals out moisture and contaminants
- Wire gauge is printed on each connector for easy ID

### Heatless Terminals and Connectors-Revolutionary New Product

- A heatless, solder-less terminal utilizing a revolutionary anaerobic sealing technology requires NO HEAT
- Simply strip the wire and crimp, activating the sealant that reacts when the copper wire is inserted into the connector to create an environmentally sealed connection
- Easily installs in a fraction of the time of comparable heat seal connectors



- Prevents the ingress of moisture and air that can result in corrosion
- Nylon insulation provides maximum abrasion and puncture resistance while remaining seamless
- Reduces overall installation costs by eliminating the need for torches or heat guns, reducing the installation time and improving productivity



Call the Velvac Sales Team: **800.783.8871** [sales@velvac.com](mailto:sales@velvac.com)

© VELVAC INC. • 2405 South Calhoun Road • New Berlin, WI 53151-2709 • Toll Free: 800.783.8871 • Fax: 262.786.4101

## TERMINALS AND CONNECTORS

### Butt Splices



#### Crimps

| Part #     | Wire Gauge | Insulation   |
|------------|------------|--------------|
| 056051-50* | 22-18      | Vinyl-butted |
| 057085-50  | 22-18      | Nylon-smls** |
| 056052-50* | 16-14      | Vinyl-butted |
| 057086-50* | 16-14      | Nylon-smls** |
| 056053-50* | 12-10      | Vinyl-butted |
| 057087-50* | 12-10      | Nylon-smls** |



| Part #     | Wire Gauge | Insulation |
|------------|------------|------------|
| 058362-50* | 22-18      | None       |
| 058028-50* | 16-14      | None       |
| 058029-50* | 12-10      | None       |

#### Brazed seam



| Part #    | Wire Gauge | Insulation |
|-----------|------------|------------|
| 056054-10 | 8          | Vinyl      |
| 056055-10 | 6          | Vinyl      |
| 056056-10 | 4          | Vinyl      |

| Part #    | Wire Gauge | Insulation |
|-----------|------------|------------|
| 055106-10 | 22-18      | Nylon      |
| 055107-10 | 16-14      | Nylon      |
| 055108-10 | 12-10      | Nylon      |

#### Helpful hint:

Terminal insulation is color-coded according to wire gauge specifications:

Red 22 - 18 AWG, 8 AWG  
 Blue 16 - 14 AWG, 6 AWG  
 Yellow 12 - 10 AWG, 4 AWG

#### Crimp/Seal

| Part #     | Wire Gauge | Insulation     |
|------------|------------|----------------|
| 055067-10  | 26-22      | Nylon          |
| 058312-50* | 22-18      | Heat shrink    |
| 055075-10  | 22-18      | Nylon & copper |
| 055075-50  | 22-18      | Nylon & copper |
| 058313-40* | 16-14      | Heat shrink    |
| 055076-10  | 16-14      | Nylon & copper |
| 055076-50  | 16-14      | Nylon & copper |
| 058314-40* | 12-10      | Heat shrink    |
| 055077-10  | 12-10      | Nylon & copper |
| 055077-50  | 12-10      | Nylon & copper |
| 055068-10  | 8          | Nylon          |

#### NOTES

Dash - "x" indicates package qty

\* Clam shell with quantity of ten (10) also available by adding "-10" to the base six digit number

\*\* Seamless



#### Step Down Splices

| Part #    | Wire Gauge  | Tube Color |
|-----------|-------------|------------|
| 055069-10 | 22-18/16-14 | Blue       |
| 055070-10 | 16-14/12-10 | Yellow     |
| 055071-10 | 12-10/8     | Pink       |

#### Crimp/Solder/Seal

| Part #    | Wire Gauge | Insulation  |
|-----------|------------|-------------|
| 056144-25 | 22-18      | Heat shrink |
| 056145-25 | 16-14      | Heat shrink |
| 056146-25 | 12-10      | Heat shrink |



#### Heatless

| Part #     | Wire Gauge | Insulation |
|------------|------------|------------|
| 056111-5   | 22-18      | Nylon      |
| 056111-100 | 22-18      | Nylon      |
| 056112-5   | 16-14      | Nylon      |
| 056112-100 | 16-14      | Nylon      |
| 056113-5   | 12-10      | Nylon      |
| 056113-100 | 12-10      | Nylon      |

## TERMINALS AND CONNECTORS

### Spade Connectors



Block spade



### Crimp

| Wire Gauge | Crimp Part # | Stud Size, Insulation | Crimp Part # | Stud Size, Insulation |
|------------|--------------|-----------------------|--------------|-----------------------|
| 22-18      | 056043-50    | 8-10, Vinyl           | 056046-50    | 4-6, Vinyl            |
| 22-18      | -            | -                     | 058345-50    | 6, Nylon              |
| 22-18      | -            | -                     | 055114-10    | 6, Nylon              |
| 22-18      | -            | -                     | 055115-10    | 10, Nylon             |
| 16-14      | 056044-50    | 8-10, Vinyl           | 056047-50*   | 4-6, Vinyl            |
| 16-14      | 057082-50    | 8-10, Nylon           | 057084-50    | 4-6, Nylon            |
| 16-14      | -            | -                     | 055125-10    | 10, Nylon             |
| 12-10      | 056045-50    | 8-10, Vinyl           | 055135-10    | 10, Nylon             |
| 12-10      | 057083-50    | 8-10, Nylon           | -            | -                     |

### Crimp/Seal

| Part #    | Wire Gauge | Stud Size |
|-----------|------------|-----------|
| 058309-50 | 22-18      | 8-10      |
| 055078-10 | 22-18      | 6         |
| 055079-10 | 22-18      | 10        |
| 058335-50 | 16-14      | 6         |
| 058310-50 | 16-14      | 8-10      |
| 058336-50 | 16-14      | 1/4"      |
| 055080-10 | 16-14      | 6         |
| 055081-10 | 16-14      | 10        |
| 058311-50 | 12-10      | 8-10      |
| 058337-50 | 12-10      | 1/4"      |
| 055082-10 | 12-10      | 10        |
| 055083-10 | 12-10      | 1/4"      |

### Crimp/Solder/Seal

| Part #    | Wire Gauge | Stud Size |
|-----------|------------|-----------|
| 056155-25 | 22-18      | 10        |
| 056156-25 | 16-14      | 10        |
| 056157-25 | 12-10      | 10        |



### Snap Terminals and Connectors

Plugs -  
butted seam



Receptacles -  
butted



Spades -  
butted



Receptacles -  
double



| Wire Gauge | Part #     | Snap Dia. Insulation | Part #    | Snap Dia. Insulation | Part #    | Stud Size Insulation | Part #    | Snap Dia. Insulation |
|------------|------------|----------------------|-----------|----------------------|-----------|----------------------|-----------|----------------------|
| 22-18      | 058338-50  | 0.156", Nylon        | 056076-50 | 0.156", Nylon        | -         | -                    | 056080-50 | 0.157", Vinyl        |
| 16-14      | 058340-50* | 0.156", Nylon        | 056078-50 | 0.156", Nylon        | 057092-50 | 8, Vinyl             | -         | -                    |

### Male/Female Bullet Connections

| Part #    | Wire Gauge | Type   | Insulation |
|-----------|------------|--------|------------|
| 055104-10 | 16-14      | Male   | Nylon      |
| 055105-10 | 16-14      | Female | Nylon      |
| 055116-10 | 22-18      | Male   | Nylon      |
| 055117-10 | 22-18      | Female | Nylon      |
| 055126-10 | 16-14      | Male   | Nylon      |
| 055127-10 | 16-14      | Female | Nylon      |



Call the Velvac Sales Team: **800.783.8871** sales@velvac.com

## TERMINALS AND CONNECTORS

### Ring Tongue Connectors

#### Crimp



Butted seam



Hooked tongue - butted seam

| Wire Gauge | Crimp Part # | Stud Size, Insulation |
|------------|--------------|-----------------------|
| 22-18      | 056001-50    | 4-6, Vinyl            |
| 22-18      | 056002-50    | 8-10, Vinyl           |
| 22-18      | 056003-50    | 12-1/4", Vinyl        |
| 22-18      | 055109-10    | 6, Nylon              |
| 22-18      | 055110-10    | 10, Nylon             |
| 22-18      | 055111-10    | 1/4", Nylon           |
| 22-18      | 055112-10    | 5/16", Nylon          |
| 22-18      | 055113-10    | 3/8", Nylon           |
| 16-14      | 056004-50    | 4-6, Vinyl            |
| 16-14      | 057075-50    | 4-6, Nylon            |
| 16-14      | 057076-50*   | 8-10, Nylon           |
| 16-14      | 056006-50*   | 12-1/4", Vinyl        |
| 16-14      | 057077-50    | 12-1/4", Nylon        |
| 16-14      | 056007-50*   | 5/16"-3/8", Vinyl     |
| 16-14      | 057078-50    | 5/16"-3/8", Nylon     |
| 16-14      | 055120-10    | 6, Nylon              |
| 16-14      | 055121-10    | 10, Nylon             |
| 16-14      | 055122-10    | 1/4", Nylon           |
| 16-14      | 055123-10    | 5/16", Nylon          |
| 16-14      | 055124-10    | 3/8", Nylon           |
| 12-10      | 056008-50*   | 8-10, Vinyl           |
| 12-10      | 057079-50    | 8-10, Nylon           |
| 12-10      | 056009-50*   | 12-1/4", Vinyl        |
| 12-10      | 057080-50    | 12-1/4", Nylon        |
| 12-10      | 056010-50    | 5/16", Vinyl          |
| 12-10      | 057081-50    | 5/16", Nylon          |
| 12-10      | 056011-50*   | 3/8", Vinyl           |
| 12-10      | 056012-50    | 7/16"-1/2", Vinyl     |
| 12-10      | 055130-10    | 10, Nylon             |
| 12-10      | 055131-10    | 1/4", Nylon           |
| 12-10      | 055132-10    | 5/16", Nylon          |
| 12-10      | 055133-10    | 3/8", Nylon           |
| 12-10      | 055134-10    | 1/2", Nylon           |

| Wire Gauge | Crimp Part # | Stud Size, Insulation |
|------------|--------------|-----------------------|
| 16-14      | 056049-50    | 4-6, Vinyl            |



Brazed seam

| Wire Gauge | Crimp Part # | Stud Size, Insulation |
|------------|--------------|-----------------------|
| 8          | 058349-50    | 8-10, Nylon           |
| 8          | 058350-50    | 12-1/4", Nylon        |
| 8          | 058351-50    | 5/16"-3/8", Nylon     |
| 8          | 058352-50    | 7/16"-1/2", Nylon     |
| 6          | 058353-50    | 12-1/4", Nylon        |
| 6          | 058354-50    | 5/16"-3/8", Nylon     |
| 6          | 058355-50    | 7/16"-1/2", Nylon     |
| 4          | 058356-50    | 12-1/4", Nylon        |
| 4          | 058357-50    | 5/16"-3/8", Nylon     |
| 4          | 058358-50    | 7/16"-1/2", Nylon     |

#### NOTES

Dash - "x" indicates package qty

\* Clam shell with quantity of ten (10) also available by adding "-10" to the base six digit number

## TERMINALS AND CONNECTORS

### Ring Tongue Connectors

Continued

#### Crimp/Seal



| Part #    | Wire Gauge | Stud Size  |
|-----------|------------|------------|
| 058334-50 | 22-18      | 6          |
| 058301-50 | 22-18      | 8-10       |
| 055064-10 | 22-18      | 6, 8, 10   |
| 055084-10 | 22-18      | 6          |
| 055085-10 | 22-18      | 8          |
| 055086-10 | 22-18      | 10         |
| 055087-10 | 22-18      | 1/4"       |
| 055088-10 | 22-18      | 5/16"      |
| 058302-50 | 16-14      | 4-6        |
| 058303-50 | 16-14      | 8-10       |
| 058304-50 | 16-14      | 1/4"       |
| 058305-50 | 16-14      | 5/16"-3/8" |
| 055065-10 | 16-14      | 6, 8, 10   |
| 055089-10 | 16-14      | 8          |
| 055090-10 | 16-14      | 10         |
| 055091-10 | 16-14      | 1/4"       |
| 055092-10 | 16-14      | 5/16"      |
| 055093-10 | 16-14      | 3/8"       |
| 058306-50 | 12-10      | 8-10       |
| 058307-50 | 12-10      | 1/4"       |
| 058308-50 | 12-10      | 5/16"-3/8" |
| 055066-10 | 12-10      | 6, 8, 10   |
| 055094-10 | 12-10      | 10         |
| 055095-10 | 12-10      | 1/4"       |
| 055096-10 | 12-10      | 5/16"      |
| 055097-10 | 12-10      | 3/8"       |

#### Crimp/Solder/Seal



| Part #    | Wire Gauge | Stud Size |
|-----------|------------|-----------|
| 056147-25 | 22-18      | 10        |
| 056149-25 | 16-14      | 1/4"      |
| 056150-25 | 16-14      | 3/8"      |
| 056151-25 | 12-10      | 10        |
| 056152-25 | 12-10      | 1/4"      |
| 056153-25 | 12-10      | 3/8"      |
| 056154-25 | 12-10      | 1/2"      |

#### NOTES

Dash - "x" indicates package quantity

\*Clam shell with quantity of ten (10) also available by adding "-10" to the base six digit number

### Three and Four Way Connectors



| Wire Gauge | Four-Way # | Insulation | Three-Way # | Insulation |
|------------|------------|------------|-------------|------------|
| 22 - 18    | 058346-10  | Vinyl      | 058363-10   | Vinyl      |
| 16 - 14    | 056084-10  | Vinyl      | 056082-10   | Vinyl      |
| 12 - 10    | -          | -          | 056083-10   | Vinyl      |

### Pig Tails



| Wire Gauge | Part #     | Insulation |
|------------|------------|------------|
| 22 - 18    | 056184-50* | Nylon      |
| 16 - 14    | 056185-50* | Nylon      |
| 12 - 10    | 056186-50* | Nylon      |

### Wire Nuts



| Part #    | Size | Color  |
|-----------|------|--------|
| 058364-50 | 71B  | Grey   |
| 058365-50 | 72B  | Blue   |
| 058366-40 | 73B  | Orange |
| 058367-10 | 74B  | Yellow |



Self strip connector

| Part #     | Wire Gauge           |
|------------|----------------------|
| 056093-50* | 18-14                |
| 056094-10  | 12-10 Run, 18-14 Tap |



Call the Velvac Sales Team: **800.783.8871** sales@velvac.com



## TERMINALS AND CONNECTORS

### Male Quick Slide Terminals And Connectors - Tab Width .250"

#### Crimp

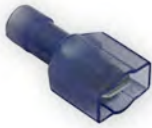

Butted seam - fully insulated



Butted seam

| Wire Gauge | Part #    | Insulation | Part #     | Insulation |
|------------|-----------|------------|------------|------------|
| 22-18      | 056069-50 | Nylon      | 056063-50  | Vinyl      |
| 22-18      | 055098-10 | Nylon      | -          | -          |
| 16-14      | 056070-50 | Nylon      | 056064-50* | Vinyl      |
| 16-14      | -         | -          | 057090-50  | Nylon      |
| 16-14      | 055100-10 | Nylon      | -          | -          |
| 12-10      | 056071-50 | Nylon      | 056065-50* | Vinyl      |
| 12-10      | -         | -          | 057091-50  | Nylon      |
| 12-10      | 055102-10 | Nylon      | -          | -          |



Double male to female

056088-50

None



90° Flag butted seam

056086-50

None

#### Crimp/Seal



Fully insulated

| Wire Gauge | Part #    | Insulation |
|------------|-----------|------------|
| 22-18      | 058315-40 | Ht Shrink  |
| 16-14      | 058316-40 | Ht Shrink  |
| 12-10      | 058317-10 | Ht Shrink  |
| 22-18      | 055118-10 | Nylon      |
| 16-14      | 055128-10 | Nylon      |
| 12-10      | 055136-10 | Nylon      |

#### Crimp/Solder/Seal



Fully insulated

| Wire Gauge | Part #    | Insulation |
|------------|-----------|------------|
| 22-18      | 056169-25 | Vinyl      |
| 16-14      | 056159-25 | Vinyl      |
| 12-10      | 056164-25 | Vinyl      |

### Female Quick Slide Terminals And Connectors - Tab Width .250"

#### Crimp



Butted seam - fully insulated



T-tap self stripping



Butted Seam

| Wire Gauge | Part #     | Insulation | Part #    | Insulation | Part #     | Insulation |
|------------|------------|------------|-----------|------------|------------|------------|
| 22-18      | 056066-50  | Nylon      | 058347-40 | Nylon      | 056060-50  | Vinyl      |
| 22-18      | 055099-10  | Nylon      | -         | -          | -          | -          |
| 16-14      | 056067-50* | Nylon      | 057096-40 | Nylon      | 056061-50* | Vinyl      |
| 16-14      | 055101-10  | Nylon      | -         | -          | 057088-50* | Nylon      |
| 12-10      | 056068-50* | Nylon      | 058348-40 | Nylon      | 056062-50* | Vinyl      |
| 12-10      | 055103-10  | Nylon      | -         | -          | 057089-50  | Nylon      |



Fully insulated

#### Crimp/Seal

| Wire Gauge | Part #    | Insulation |
|------------|-----------|------------|
| 22-18      | 058318-50 | Ht Shrink  |
| 22-18      | 055119-10 | Nylon      |
| 16-14      | 058319-50 | Ht Shrink  |
| 16-14      | 055129-10 | Nylon      |
| 12-10      | 058320-10 | Ht Shrink  |
| 12-10      | 055137-10 | Nylon      |

#### Crimp/Solder/Seal

| Wire Gauge | Part #    | Insulation | Part #    | Insulation |
|------------|-----------|------------|-----------|------------|
| 22-18      | 056165-25 | Ht Shrink  | 056168-25 | Vinyl      |
| 16-14      | 056166-25 | Ht Shrink  | 056158-25 | Vinyl      |
| 12-10      | 056167-25 | Ht Shrink  | 056160-25 | Vinyl      |



Fully insulated



Butted Seam

#### NOTES

Dash- "x" indicates package qty

\* Clam shell with quantity of ten (10) also available by adding "-10" to the base six digit number

## TERMINALS AND CONNECTORS

### Terminal Kits

- Convenient, pre-packaged terminal assortments
- Durable, see-through plastic cases with handy "locator" cards are easy to identify and refill
- Multi-functional kits can be displayed on the front counter to attract the impulse sale of single terminals or used as mini storage system

| Part # | Description              |
|--------|--------------------------|
| 056107 | Solderless terminal kit  |
| 056108 | Heat-shrink terminal kit |
| 056109 | Electrical connector kit |



### Solderless Terminal Kit

- 195 total fittings

| Part # | Description             | Qty. |
|--------|-------------------------|------|
| 057085 | 22-18 ga. Butt conn     | 12   |
| 057086 | 16-14 ga. Butt conn     | 12   |
| 057087 | 12-10 ga. Butt conn     | 12   |
| 056002 | 22-18 ga. Ring tongue   | 12   |
| 056005 | 16-14 ga. Ring tongue   | 12   |
| 056011 | 12-10 ga. Ring tongue   | 12   |
| 056043 | 22-18 ga. Spade tubing  | 12   |
| 056044 | 16-14 ga. Spade         | 12   |
| 056045 | 12-10 ga. Spade         | 12   |
| 057061 | 16-14 ga. Shrink tubing | 5    |
| 057062 | 12-10 ga. Shrink tubing | 5    |
| 057149 | 22-18 ga. Shrink tubing | 5    |
| 056061 | 16-14 ga. F. quick      | 12   |
| 056062 | 12-10 ga. F. quick      | 12   |
| 056064 | 16-14 ga. M. quick      | 12   |
| 056065 | 12-10 ga. M. quick      | 12   |
| 058340 | 16-14 ga. Snap plug     | 12   |
| 056078 | 16-14 ga. Snap plug     | 12   |

### Heat Shrink Terminal Kit

- 132 total fittings

| Part # | Description              | Qty. |
|--------|--------------------------|------|
| 058312 | 22-18 ga. Butt conn      | 8    |
| 058313 | 16-14 ga. Butt conn      | 8    |
| 058314 | 12-10 ga. Butt conn      | 8    |
| 058309 | 22-18 ga. spade          | 8    |
| 058310 | 16-14 ga. spade          | 8    |
| 058311 | 12-10 ga. spade          | 8    |
| 058302 | 16-14 ga. Ring tongue    | 8    |
| 058303 | 16-14 ga. Ring tongue    | 8    |
| 058304 | 16-14 ga. Ring tongue    | 8    |
| 058305 | 16-14 ga. Ring tongue    | 8    |
| 058306 | 12-10 ga. Ring tongue    | 8    |
| 058308 | 12-10 ga. Ring tongue    | 8    |
| 058315 | 22-18 ga. F. quick slide | 6    |
| 058316 | 16-14 ga. F. quick slide | 6    |
| 058317 | 12-10 ga. F. quick slide | 6    |
| 058318 | 22-18 ga. F. quick slide | 12   |
| 058319 | 16-14 ga. F. quick slide | 6    |
| 058320 | 12-10 ga. F. quick slide | 6    |

### Electrical Connector Kit

- 170 total fittings

| Part # | Description              | Qty. |
|--------|--------------------------|------|
| 056051 | 22-18 ga. Butt conn      | 12   |
| 056052 | 16-14 ga. Butt conn      | 12   |
| 056053 | 12-10 ga. Butt conn      | 12   |
| 021007 | 3/8" tube O.D. clip      | 6    |
| 056091 | 22-14 ga. Pigtail        | 15   |
| 056093 | 18-14 Tap                | 10   |
| 056002 | 22-18 Ring tongue        | 12   |
| 056005 | 16-14 Ring tongue        | 12   |
| 056008 | 12-10 Ring tongue        | 12   |
| 021009 | 1/2" tube O.D. tube clip | 6    |
| 056092 | 18-10 ga. Pigtail        | 15   |
| 056094 | 12-10 run 18-14 tap      | 10   |
| 056043 | 22-18 Spade              | 12   |
| 056044 | 16-14 ga. Spade          | 12   |
| 056045 | 12-10 ga. Spade          | 12   |

### Solderless Terminal Fleet Maintenance Kit

- Packaged in a heavy-duty steel box with 20 popular styles of solderless terminals and nylon tie straps

| Part # | Description               |
|--------|---------------------------|
| 056096 | Kit with crimping tool    |
| 056097 | Kit without crimping tool |



NOTE: Terminals also sold separately on pages E24-E28. Tie straps sold separately on page E35. Crimping tool sold separately on page E37

| Part # | Qty. | Part # | Qty. |
|--------|------|--------|------|
| 056002 | 20   | 056044 | 20   |
| 056004 | 20   | 056047 | 20   |
| 056005 | 20   | 058340 | 20   |
| 056006 | 20   | 056078 | 20   |
| 056061 | 20   | 056093 | 20   |
| 056064 | 20   | 056050 | 20   |
| 056067 | 20   | 056051 | 20   |
| 056070 | 20   | 056052 | 20   |
| 056009 | 20   | 056053 | 20   |
| 056011 | 20   | 056186 | 20   |
| 056014 | 20   |        |      |



Call the Velvac Sales Team: **800.783.8871** sales@velvac.com

## PRIMARY WIRE AND ACCESSORIES

### General Purpose Primary Wire

- Soft annealed copper strands
- PVC outer jacket
- Designed to withstand temperatures up to +250°F
- Wire meets SAE J1128 Type GPT requirements



| Part #   | Wire Gauge | Spool Size | Color  |
|----------|------------|------------|--------|
| 051101   | 18         | 100'       | Black  |
| 051103   | 18         | 100'       | Red    |
| 051105   | 18         | 100'       | White  |
| 051117-6 | 16         | 1000'      | Black  |
| 051121-6 | 16         | 1000'      | Red    |
| 051123-6 | 16         | 1000'      | White  |
| 051119-6 | 16         | 1000'      | Green  |
| 051117   | 16         | 100'       | Black  |
| 051121   | 16         | 100'       | Red    |
| 051123   | 16         | 100'       | White  |
| 051125   | 16         | 100'       | Yellow |
| 051127   | 16         | 100'       | Blue   |
| 051129   | 16         | 100'       | Brown  |
| 051119   | 16         | 100'       | Green  |
| 051135-6 | 14         | 1000'      | Black  |
| 051139-6 | 14         | 1000'      | Red    |
| 051141-6 | 14         | 1000'      | White  |
| 051143-6 | 14         | 1000'      | Yellow |
| 051145-6 | 14         | 1000'      | Blue   |
| 051147-6 | 14         | 1000'      | Brown  |
| 051137-6 | 14         | 1000'      | Green  |
| 051135   | 14         | 100'       | Black  |
| 051139   | 14         | 100'       | Red    |
| 051141   | 14         | 100'       | White  |

| Part #   | Wire Gauge | Spool Size | Color  |
|----------|------------|------------|--------|
| 051143   | 14         | 100'       | Yellow |
| 051145   | 14         | 100'       | Blue   |
| 051147   | 14         | 100'       | Brown  |
| 051137   | 14         | 100'       | Green  |
| 051157-7 | 12         | 500'       | Red    |
| 051159-7 | 12         | 500'       | White  |
| 051161-7 | 12         | 500'       | Yellow |
| 051163-7 | 12         | 500'       | Blue   |
| 051155-7 | 12         | 500'       | Green  |
| 051153   | 12         | 100'       | Black  |
| 051157   | 12         | 100'       | Red    |
| 051159   | 12         | 100'       | White  |
| 051161   | 12         | 100'       | Yellow |
| 051163   | 12         | 100'       | Blue   |
| 051165   | 12         | 100'       | Brown  |
| 051155   | 12         | 100'       | Green  |
| 051175-7 | 10         | 500'       | Black  |
| 051171-7 | 10         | 500'       | Red    |
| 051177-7 | 10         | 500'       | White  |
| 051175   | 10         | 100'       | Black  |
| 051171   | 10         | 100'       | Red    |
| 051177   | 10         | 100'       | White  |
| 051173   | 10         | 100'       | Blue   |

### Primary Wire Rack

- Holds (12) 100' spools, (8) 100' and (2) 1000' spools or (4) 1000' spools
- Heavy gauge plated steel construction
- Wire spools sold separately

| Part # | Description       |
|--------|-------------------|
| 691015 | Primary wire rack |



## SPIRAL WRAP

- Replace worn or damaged 3-in-1 or 4-in-1 air/electrical assembly wrap
- Use to protect or bundle jumper lines, slider hoses, ABS lines, hydraulic hoses and more
- Prevents tangling and potential damage to lines
- Various sizes allow for customized bundle combinations

| 100' Coil | Diameter |
|-----------|----------|
| 020078    | 1.25"    |
| 020079    | 1.50"    |
| 020080    | 2"       |



## SPLIT LOOM

### Convoluted Split Loom

- High temperature loom suitable for engine compartment use
- Split seam permits easy insertion and repair of wire, tubing, cable, etc.
- Convoluted black nylon allows for excellent pinch and abrasion resistance
- Designed to withstand temperatures from -40° to +200°F
- Meets FMVSS 302 requirements

| 100' Coil | 250' Coil | Loom I.D. |
|-----------|-----------|-----------|
| 020104-7  | 020104    | 1/4"      |
| 020106-7  | 020106    | 3/8"      |
| 020108-7  | 020108    | 1/2"      |
| 020110-7  | 020110    | 5/8"      |
| 020112-7  | 020112    | 3/4"      |
| 020116-7  | -         | 1"        |
| 020117-7  | -         | 1-1/4"    |
| 020118-7  | -         | 1-1/2"    |
| 020119-7  | -         | 1-7/8"    |



**NOTE: Part numbers listed in RED are NEW!**



Call the Velvac Sales Team: **800.783.8871** [sales@velvac.com](mailto:sales@velvac.com)

## PRIMARY WIRE AND ACCESSORIES

### Gray Jacketed Parallel Wire

| Part #   | Wire Gauge | Spool Size |
|----------|------------|------------|
| 051050   | 16         | 100'       |
| 051058   | 14         | 100'       |
| 051066   | 12         | 100'       |
| 051050-7 | 16         | 500'       |
| 051058-7 | 14         | 500'       |



### Three-Way and Four-Way Bonded Parallel Wire\*

| Part # | Wire Gauge | Conductor | Wire Color               | Spool Size |
|--------|------------|-----------|--------------------------|------------|
| 051052 | 16         | Three     | Brown-Green-Yellow       | 100'       |
| 051060 | 16         | Three     | Brown-Green-Yellow       | 100'       |
| 051054 | 14         | Four      | Brown-Green Yellow-White | 100'       |
| 051062 | 14         | Four      | Brown-Green Yellow-White | 100'       |

#### NOTES

See page E8 for ATA color code description

\* Round wire glued together

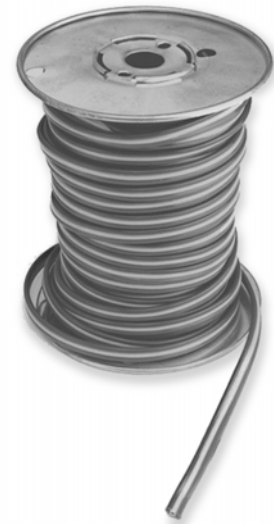

## HEAT-SHRINK TUBING

### Heavy Wall Heat-Shrink Tubing With Liner



| Part #    | Wire Gauge | Length | I.D. Pre-Shrink | I.D. After |
|-----------|------------|--------|-----------------|------------|
| 057146-10 | 18-14      | 6"     | .300"           | .100"      |
| 057148-5  | 18-14      | 48"    | .300"           | .100"      |
| 057058-10 | 14-6       | 6"     | .400"           | .150"      |
| 057159-5  | 14-6       | 48"    | .400"           | .150"      |
| 057059-10 | 8-1        | 6"     | .750"           | .200"      |
| 057150-25 | 8-1        | 1-1/2" | .750"           | .200"      |
| 057152-2  | 8-1        | 48"    | .750"           | .200"      |
| 057060-10 | 2-4/0      | 6"     | 1.100"          | .375"      |
| 057097-25 | 2-4/0      | 1-1/2" | 1.100"          | .375"      |
| 057160-2  | 2-4/0      | 48"    | 1.100"          | .375"      |

- Durable polyolefin construction
- Inner liner melts to produce a flexible, waterproof seal for the life of the connection
- UL Listed/CSA certified in direct buried applications
- Flame retardant
- 3:1 shrink ratio
- See page E38 for heat gun - recommended heat range is 250°F (120°C) to 485°F (250°C)

#### NOTES

See next page for more heavy wall heat-shrink tubing with liner

## HEAT-SHRINK TUBING

### Heavy Wall Heat-Shrink Tubing With Liner

- Durable polyolefin construction
- Inner liner melts to produce a flexible, waterproof seal for the life of the connection
- UL Listed/CSA certified in direct buried applications
- Flame retardant
- 3:1 shrink ratio
- See page E38 for heat gun - recommended heat range is 250°F (120°C) to 485°F (250°C)

| Part #    | Wire Gauge | Length | I.D. Pre-Shrink | I.D. After |
|-----------|------------|--------|-----------------|------------|
| 057147-10 | 18-14      | 6"     | .300"           | .100"      |
| 057158-10 | 14-6       | 6"     | .400"           | .150"      |
| 057073-10 | 8-1        | 6"     | .750"           | .220"      |
| 057151-25 | 8-1        | 1-1/2" | .750"           | .220"      |
| 057153-2  | 8-1        | 48"    | .750"           | .220"      |
| 057074-10 | 2-4/0      | 6"     | 1.100"          | .375"      |
| 057098-25 | 2-4/0      | 1-1/2" | 1.100"          | .375"      |
| 057174-2  | 2-4/0      | 48"    | 1.100"          | .375"      |



### Thin Wall Heat-Shrink Tubing Without Liner

- Durable polyolefin construction
- UL recognized and flame retardant
- Continuous operating temperature: -67°F (-55°C) to 275°F (135°C)
- Recommended heat range is 250°F (120°C) to 485°F (250°C)
- 2:1 shrink ration

| Part #    | Wire Gauge | Length | Color  | I.D. Pre-Shrink | I.D. After |
|-----------|------------|--------|--------|-----------------|------------|
| 057061-25 | 16-14      | 2"     | Blue   | .250"           | .125"      |
| 057062-25 | 12-10      | 2"     | Yellow | .375"           | .187"      |
| 057149-25 | 22-18      | 6"     | Red    | .125"           | .062"      |
| 057112-10 | -          | 6"     | Black  | .190"           | .093"      |
| 057113-10 | -          | 6"     | White  | .250"           | .125"      |
| 057114-10 | -          | 6"     | Red    | .375"           | .187"      |
| 057115-10 | -          | 6"     | Black  | .500"           | .250"      |
| 057116-10 | -          | 6"     | White  | .750"           | .370"      |
| 057117-10 | -          | 6"     | Red    | 1.00"           | .500"      |

#### NOTES

Dash - "x" indicates package quantity



### Thin Wall Heat-Shrink Tubing

- Disk packaging for convenient storage and waste reduction
- Packaged for showroom display and impulse buying
- Available in three colors corresponding to NEMA color-codes
- Easily fits in toolbox

| Part # | Description        |
|--------|--------------------|
| 057131 | 3/16" I.D., Red    |
| 057132 | 1/4" I.D., Blue    |
| 057133 | 5/16" I.D., Yellow |

Packaged in 8' rolls - one roll per disk pack



Call the Velvac Sales Team: **800.783.8871** sales@velvac.com

## HEAT-SHRINK TUBING

- Convenient, pre-packaged tubing assortments save time by keeping popular sized tubing in 6" lengths close at hand
- Durable, see-through plastic cases with handy "locator" cards are easy to find items and refill

| Part # | Description                       |
|--------|-----------------------------------|
| 057110 | Heavy wall heat-shrink tubing kit |
| 057111 | Thin wall heat-shrink             |

### Heat-Shrink Tubing Kits



057110

#### Heavy Wall Heat-Shrink Tubing Kit

- 36 total fittings

| Part # | Pieces | Description |
|--------|--------|-------------|
| 057060 | 4 pcs  | 1.10" Black |
| 057059 | 4 pcs  | .750" Black |
| 057058 | 10 pcs | .400" Black |
| 057074 | 4 pcs  | 1.10" Red   |
| 057073 | 4 pcs  | .750" Red   |
| 057158 | 10 pcs | .400" Red   |

#### Thin Wall Heat-Shrink Tubing Kit

- 86 total fittings

| Part # | Pieces | Description |
|--------|--------|-------------|
| 057112 | 36 pcs | 3/16" Black |
| 057113 | 24 pcs | 1/4" White  |
| 057114 | 12 pcs | 3/8" Red    |
| 057115 | 6 pcs  | 1/2" Black  |
| 057116 | 4 pcs  | 3/4" White  |
| 057117 | 4 pcs  | 1" Red      |



057111

## TIE STRAPS, GROMMETS AND WIRE CLIPS

### Cable Tie Straps

| Stand. Part # | BK UV Tie Part # | Length | Min. Diam | Max. Diam | Min Ten. Strength | Stud Size |
|---------------|------------------|--------|-----------|-----------|-------------------|-----------|
| 090002-100    | 090064-100       | 5"     | 1/16"     | 1-1/4"    | 30 lb             | -         |
| 090004-100    | 090067-100       | 7"     | 1/16"     | 1-3/4"    | 50 lb             | 10        |
| 090006-25     | 090070-25        | 14"    | 3/16"     | 4"        | 120 lb            | -         |
| 090010-25     | 090071-25        | 14"    | 3/16"     | 4"        | 120 lb            | 14        |
| 090014-100    | 090066-100       | 7"     | 1/16"     | 1-3/4"    | 50 lb             | -         |
| 090016-100    | 090068-100       | 14"    | 1/16"     | 4"        | 50 lb             | -         |
| -             | 090030-50        | 24"    | -         | -         | 175 lb            | -         |
| -             | 090029-50        | 36"    | -         | -         | 175 lb            | -         |



090002, 090064



090004, 090067



090006, 090070



090010, 090071



090014, 090066

090016, 090068

090030, 090029

#### NOTES

Dash "-xxx" indicates package quantity

## TIE STRAPS, GROMMETS AND WIRE CLIPS

### Rubber Grommets

| Part # | A      | B       | C     | D     | E     |
|--------|--------|---------|-------|-------|-------|
| 021059 | 9/16"  | 7/16"   | 5/16" | 3/16" | 1/16" |
| 021061 | 1-3/8" | 1"      | 1/2"  | 1/2"  | 1/8"  |
| 021063 | 1-1/4" | 31/32"  | 5/8"  | 3/8"  | 1/8"  |
| 021065 | 1-3/4" | 1-3/16" | 3/4"  | 1/2"  | 7/32" |

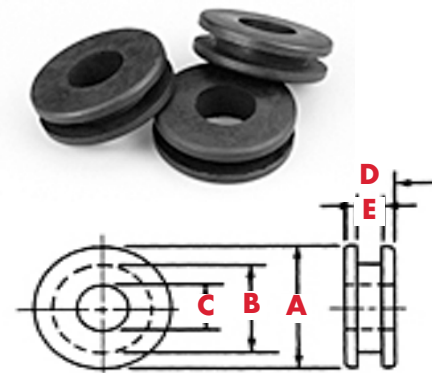

### Nylon Grommet



- Provides protection for 16, 14 and 12 gauge wires
- Fits into a 3/8" diameter mounting hole with wall thickness up to 1/8"

| Part # | Description   |
|--------|---------------|
| 021070 | Nylon grommet |

### Tube Clips



- Zinc-plated steel construction for corrosion resistance
- Rubber coating protects tubing and wires

| Part # | Tube O.D. | Mounting Bolt Size |
|--------|-----------|--------------------|
| 021001 | 3/16"     | 1/4"               |
| 021003 | 1/4"      | 1/4"               |
| 021005 | 5/16"     | 1/4"               |
| 021007 | 3/8"      | 1/4"               |
| 021009 | 1/2"      | 1/4"               |
| 021011 | 5/8"      | 1/4"               |
| 021013 | 3/4"      | 3/8"               |
| 021015 | 7/8"      | 1/4"               |
| 021017 | 1"        | 1/4"               |
| 021019 | 1-1/4"    | 5/16"              |

### Wire Clips



- Spring tension clips are ideal for holding primary wire to truck frame
- Tips are vinyl coated for wire protection

| Part # | Description    |
|--------|----------------|
| 021021 | 1/4" Wire clip |
| 021023 | 1/2" Wire clip |

### Rubber Cushioned Clamps



| Clamp Diam. | 3/8" Mount Screw, 5/8" Wide Part # | 1/4" Mount Screw, 1/2" Wide Part # |
|-------------|------------------------------------|------------------------------------|
| 1/4"        | 021102                             | 021114                             |
| 3/8"        | 021103                             | 021115                             |
| 1/2"        | 021104                             | 021116                             |
| 5/8"        | 021100                             | 021117                             |

| Clamp Diam. | 3/8" Mount Screw, 5/8" Wide Part # | 1/4" Mount Screw, 1/2" Wide Part # |
|-------------|------------------------------------|------------------------------------|
| 3/4"        | 021105                             | 021118                             |
| 1"          | 021106                             | 021119                             |
| 1-1/4"      | 021107                             | -                                  |
| 1-1/2"      | 021108                             | -                                  |
| 2"          | 021109                             | -                                  |
| 2-1/2"      | 021110                             | -                                  |
| 3"          | 021111                             | -                                  |
| 4"          | 021112                             | -                                  |
| 5"          | 021113                             | -                                  |



Call the Velvac Sales Team: **800.783.8871** [sales@velvac.com](mailto:sales@velvac.com)





### Work Lights

- Incandescent light includes grounded metal swing-open bulb guard and 25' 16/3 outdoor all-weather power cord (cord remains flexible in sub-zero temperatures to -20°F)
- On/Off switch, grounded three prong outlet and 13 amp resettable circuit breaker built into handle
- Metal hanging hook
- For use with up to 75 watt standard incandescent bulb (not included)

| Part # | Description |
|--------|-------------|
| 057123 | Work light  |



### Deluxe Crimping Tool

- Crimps terminals ranging in size from 26 to 6 gauge
- Five popular sized bolt cutting stations cleanly cut mild steel and nonferrous material

| Part # | Description          |
|--------|----------------------|
| 058026 | Deluxe crimping tool |



### Economy Crimping Tool

- Accepts 8 through 4/0 gauge terminals, connectors, lugs
- Hammer required for operation

| Part # | Description           |
|--------|-----------------------|
| 058030 | Economy crimping tool |



### Short Tube Work Light 13 Watt

- Fluorescent light features new ergonomic handle, shatter resistant housing and 25' 16/3 attached cord
- Ballast, On/Off switch and three prong tool outlet built into bottom end of handle
- Handle accepts 360° adjustable magnet mounting clip allowing lamp to adhere to metal surface
- Shatter resistant polycarbonate lens with 270° arc of light
- 360° adjustable swivel hanging hook
- No tools needed for easy bulb replacement means it's cool and energy efficient
- Includes 13 watt fluorescent twin tube

| Part # | Description     |
|--------|-----------------|
| 057125 | Light - 13 Watt |



### Heavy-Duty Crimping Tool

- For crimp-type terminals from 6 to 4/0 gauge
- Rotating, letter-coded crimping die
- Reference guides on handles for proper die settings

| Part # | Description              |
|--------|--------------------------|
| 058171 | Heavy-duty crimping tool |
| 058172 | Replacement left jaw     |
| 058173 | Replacement right jaw    |



### Long Tube Work Light 15 Watt

- Fluorescent light features shatter resistant lamp housing an 25' 18/2 attached power cord
- On/Off switch built into handle
- Plug-in ballast built into power cord plug
- Non-glare reflector
- 360° adjustable swivel hanging hook

| Part # | Description     |
|--------|-----------------|
| 057124 | Light - 15 Watt |



### Copper Cable Cutter

- Capable of cutting up to 1" diameter copper stranded electrical cable
- 13" long steel handles with vinyl hand grips

| Part # | Description         |
|--------|---------------------|
| 057072 | Copper cable cutter |



### Compact Cable Cutter

- Designed to cut copper wire and cable up to 4/0 gauge

| Part # | Description          |
|--------|----------------------|
| 057071 | Compact cable cutter |

## SHOP TOOLS AND ACCESSORIES



### Heat Gun

- Produces temperatures from 750° to 1100°F
- Built-in circuit breaker and three position switch (Hot/Off/Fan only)

| Part # | Description |
|--------|-------------|
| 058160 | Heat gun    |



### Triple Outlet All-Weather Extension Cord

- 50' 12/3 high visibility yellow cord rated at 15 amps, 125 VDC
- Heavy duty power block at female end with resettable 15 amp circuit breaker and three grounded outlets

| Part # | Description        |
|--------|--------------------|
| 057128 | 50' Extension cord |



### General Purpose Vinyl Electrical Tape

- Rated to 176°F (80°C)
- Meets UL510 requirements for UV resistance
- UL listed 539H and meets Canadian Standards Association LR48769

| Part # | Tape Thickness | Roll Size  |
|--------|----------------|------------|
| 058382 | 7 mil          | 3/4" x 60' |



### 25' Cord Reel

- Retractable 25' 16/3 cord rated at 10 amps, 125 VDC
- Housing constructed of high impact plastic with 4 built-in grounded outlets, 10 amp resettable circuit breaker and a convenient wind-up knob
- When completely wound, reel fits easily into tool box or drawer
- Carrying handle attached for convenient portability

| Part # | Description   |
|--------|---------------|
| 057126 | 25' Cord reel |



### 50' Cord Reel

- Retractable 50' 14/3 yellow cord rated at 13 amps, 125 VDC to -40°
- Heavy duty cord includes heavy duty power block with built-in resettable 13 amp circuit breaker and three grounded outlets
- Industrial/commercial grade auto ratcheting plastic alloy reel housing with built-in carrying handle
- Includes quick release wall/ceiling mounting bracket for portability
- All hardware included

| Part # | Description   |
|--------|---------------|
| 057127 | 50' Cord reel |



### Silicon Self-Fusing Tape

- Tape self fuses and cures in 24 hours to form a permanent moisture tight seal
- Has no adhesive lining leaving the application clean with no sticky residue
- Provides high tech alternative to heat shrink tubing
- Ideal for high temperature applications such as battery terminals
- High dielectric strength
- Temperature range: -85° to +500°F
- Packaged in clamshell, 1" wide, 20' long rolls (qty 1 per clamshell)

| Part #  | Color | Description      |
|---------|-------|------------------|
| 058380* | Black | Self-fusing tape |
| 058381* | Red   | Self-fusing tape |

\*Add -4 to the part number for 10 piece bucket display in Retail section



Call the Velvac Sales Team: **800.783.8871** sales@velvac.com

© VELVAC INC. • 2405 South Calhoun Road • New Berlin, WI 53151-2709 • Toll Free: 800.783.8871 • Fax: 262.786.4101

**OUR PARTS PUT YOU IN THE PASSING LANE**

# **FITTINGS & HARDWARE**

## **Precision engineered.**

Velvac offers one of the most comprehensive fittings lines in the industry. From push-lock fittings with an engineered tube retention system and seal design for superior holding and side-load retention capabilities, to more traditional brass male and female fittings, Velvac has you covered.

- **Corrosion resistant**
- **Heavy gauge to exceed SAE torque requirements**
- **Extended diameter range**



# FITTINGS & HARDWARE

## PUSH-LOCK AIR BRAKE FITTINGS

- Designed for use with SAE J844 nylon tubing
- DOT 49CFR 571.106 compliant high strength composite fittings offer weight savings over all brass style fittings currently being used by many OE vehicle manufacturers
- Fittings meet performance requirements as stated in SAE J1131\*
- Operating temperatures from -45°F to +140°F
- Maximum operating pressure 145 psi
- Elbows and male branch fittings with built-in swivel for positioning
- Engineered tube retention system and seal design for superior holding and side load retention
- Positive release bushing for easy insertion and removal of tubing
- Thread sealant applied to all male pipe threads to reduce installation time and expense

\* Indicates parts that DO NOT meet DOT or SAE specification for air brake applications

### WARNING!

Velvac's line of push-lock brake fittings and tubing are designed only for use in vehicles where air is utilized as the operating fluid. As such, Velvac's push-lock air brake fittings should only be used in a manner consistent with the manufacturer's specifications.

Using Velvac's push-lock fittings or tubing improperly or in a manner inconsistent with the manufacturer's specifications may result in serious injury or property damage. For example, Velvac's push-lock fittings and tubing are not intended for use in environments exceeding 145 psi and only for temperatures between -45°F and +140°F. Velvac push-lock fittings and tubing are intended for use only as defined in 49CFR571.106.

Further, the U.S. Department of Transportation prohibits the use of push-lock fittings and nylon tubing as a connection between (I) a semi-tractor & trailer, or (II) a drive shaft and chassis.

**NOTE: 1/8" push-lock fittings DO NOT meet DOT or SAE specifications for air brake applications.**

### 90° Male Swivel Elbows (Sealant applied)

- Composite body with brass pipe-fitting end



| Part #  | Tube Size | Pipe Size |
|---------|-----------|-----------|
| 016212* | 1/8"      | 1/8"      |
| 016214* | 1/8"      | 1/4"      |
| 016222  | 5/32"     | 1/8"      |
| 016270  | 5/32"     | 1/4"      |
| 016271  | 3/16"     | 1/8"      |
| 016242  | 1/4"      | 1/8"      |
| 016244  | 1/4"      | 1/4"      |
| 016246  | 1/4"      | 3/8"      |
| 016254  | 1/4"      | 1/2"      |
| 016262  | 3/8"      | 1/8"      |
| 016264  | 3/8"      | 1/4"      |
| 016266  | 3/8"      | 3/8"      |
| 016268  | 3/8"      | 1/2"      |
| 016284  | 1/2"      | 1/4"      |
| 016286  | 1/2"      | 3/8"      |
| 016288  | 1/2"      | 1/2"      |
| 016278  | 5/8"      | 3/4"      |
| 016279  | 5/8"      | 3/8"      |
| 016281  | 5/8"      | 1/2"      |
| 016276  | 3/4"      | 1/2"      |
| 016277  | 3/4"      | 3/4"      |

### Union 'Y'

- Composite body



| Part # | Tube Size        |
|--------|------------------|
| 016289 | 1/4 x 1/4 x 1/4" |
| 016291 | 1/4 x 1/4 x 3/8" |
| 016290 | 3/8 x 3/8 x 3/8" |

### 45° Male Swivel Elbows (Sealant applied)

- Composite body with brass pipe-fitting end



| Part #  | Tube Size | Pipe Size |
|---------|-----------|-----------|
| 016412* | 1/8"      | 1/8"      |
| 016451  | 5/32"     | 1/8"      |
| 016442  | 1/4"      | 1/8"      |
| 016444  | 1/4"      | 1/4"      |
| 016446  | 1/4"      | 3/8"      |
| 016452  | 3/8"      | 1/8"      |
| 016464  | 3/8"      | 1/4"      |
| 016466  | 3/8"      | 3/8"      |
| 016947  | 3/8"      | 1/2"      |
| 016453  | 1/2"      | 1/4"      |
| 016486  | 1/2"      | 3/8"      |
| 016950  | 1/2"      | 1/2"      |
| 016454  | 5/8"      | 3/8"      |
| 016450  | 5/8"      | 1/2"      |
| 016455  | 5/8"      | 3/4"      |
| 016456  | 3/4"      | 3/8"      |
| 016457  | 3/4"      | 1/2"      |

### Union Tees

- Composite body



| Part #  | Tube Size        |
|---------|------------------|
| 016910* | 1/8"             |
| 016920  | 5/32"            |
| 016930* | 3/16"            |
| 016940  | 1/4"             |
| 016960  | 3/8"             |
| 016980  | 1/2"             |
| 016985  | 1/2 x 1/2 x 3/8" |
| 016982  | 5/8"             |



Call the Velvac Sales Team: **800.783.8871** sales@velvac.com

© VELVAC INC. • 2405 South Calhoun Road • New Berlin, WI 53151-2709 • Toll Free: 800.783.8871 • Fax: 262.786.4101

# FITTINGS & HARDWARE

## PUSH-LOCK AIR BRAKE FITTINGS

### Bulkhead Unions

- Brass construction



| Part #  | Tube Size |
|---------|-----------|
| 016810* | 1/8"      |
| 016840  | 1/4"      |
| 016860  | 3/8"      |
| 016880  | 1/2"      |

### Female Bulkhead Connectors



| Part # | Tube Size | Thread Size |
|--------|-----------|-------------|
| 016814 | 1/4"      | 1/8"        |
| 016812 | 1/4"      | 1/4"        |
| 016813 | 3/8"      | 1/4"        |
| 016815 | 3/8"      | 3/8"        |
| 016816 | 1/2"      | 3/8"        |

### Full Unions

- Composite body



| Part #  | Tube Size A | Tube Size B |
|---------|-------------|-------------|
| 016610* | 1/8"        | 1/8"        |
| 016620  | 5/32"       | 5/32"       |
| 016630* | 3/16"       | 3/16"       |
| 016640  | 1/4"        | 1/4"        |
| 016660  | 3/8"        | 3/8"        |
| 016680  | 1/2"        | 1/2"        |
| 016670  | 5/8"        | 5/8"        |
| 016621  | 3/4"        | 3/4"        |
| 016623* | 5/32"       | 1/4"        |
| 016622  | 1/4"        | 3/8"        |
| 016624  | 3/8"        | 1/2"        |

### 'Y' Male Branches

- Composite body



| Part # | Tube Size | Thread Size |
|--------|-----------|-------------|
| 016294 | 1/4"      | 1/4"        |
| 016295 | 3/8"      | 1/4"        |

### Male Run Tees

- Brass/composite



| Part # | Tube Size | Pipe Size |
|--------|-----------|-----------|
| 016400 | 1/4"      | 1/8"      |
| 016401 | 1/4"      | 1/4"      |
| 016402 | 3/8"      | 1/4"      |
| 016403 | 3/8"      | 3/8"      |
| 016404 | 3/8"      | 1/2"      |
| 016405 | 1/2"      | 3/8"      |
| 016406 | 1/2"      | 1/2"      |
| 016407 | 5/8"      | 1/2"      |
| 016409 | 1/4"      | 3/8"      |

### Female Elbows



| Part # | Tube Size | Thread Size |
|--------|-----------|-------------|
| 016247 | 1/4"      | 1/8"        |
| 016248 | 1/4"      | 1/4"        |
| 016249 | 3/8"      | 1/4"        |
| 016250 | 3/8"      | 3/8"        |

### Plug In 90° Elbows



| Part # | Tube Size |
|--------|-----------|
| 016348 | 1/4"      |

### Male Connectors

(Sealant supplied)



| Part #  | Tube Size | Pipe Size |
|---------|-----------|-----------|
| 016110* | 1/8"      | 1/16"     |
| 016112* | 1/8"      | 1/8"      |
| 016114* | 1/8"      | 1/4"      |
| 016120  | 5/32"     | 1/16"     |
| 016122  | 5/32"     | 1/8"      |
| 016124  | 5/32"     | 1/4"      |
| 016121* | 3/16"     | 1/8"      |
| 016142  | 1/4"      | 1/8"      |
| 016144  | 1/4"      | 1/4"      |
| 016146  | 1/4"      | 3/8"      |
| 016162  | 3/8"      | 1/8"      |
| 016164  | 3/8"      | 1/4"      |
| 016166  | 3/8"      | 3/8"      |
| 016168  | 3/8"      | 1/2"      |
| 016184  | 1/2"      | 1/4"      |
| 016186  | 1/2"      | 3/8"      |
| 016188  | 1/2"      | 1/2"      |
| 016951  | 3/4"      | 1/2"      |
| 016161  | 3/4"      | 3/4"      |
| 016163  | 5/8"      | 3/8"      |
| 016189  | 5/8"      | 1/2"      |
| 016187  | 3/4"      | 3/8"      |

### Female Connectors

(Sealant applied)



| Part # | Tube Size | Pipe Size |
|--------|-----------|-----------|
| 016102 | 1/4"      | 1/8"      |
| 016103 | 1/4"      | 1/4"      |
| 016104 | 3/8"      | 1/4"      |
| 016105 | 3/8"      | 3/8"      |

\* Indicates parts that DO NOT meet DOT or SAE specification for air brake applications

# FITTINGS & HARDWARE

## PUSH-LOCK AIR BRAKE FITTINGS

### Union 90° Elbows

- Composite body



| Part #  | Tube Size |
|---------|-----------|
| 016282  | 5/32"     |
| 016305* | 3/16"     |
| 016283  | 1/4"      |

\* Indicates parts that DO NOT meet DOT or SAE specification for air brake applications

### Male Branch Swivel Tees

- (Sealant applied)
- Composite body



| Part #  | Tube Size  | Pipe Size |
|---------|------------|-----------|
| 016312* | 1/8"       | 1/8"      |
| 016314* | 1/8"       | 1/4"      |
| 016342  | 1/4"       | 1/8"      |
| 016344  | 1/4"       | 1/4"      |
| 016343  | 1/4 x 1/4" | 3/8"      |
| 016364  | 3/8"       | 1/4"      |
| 016366  | 3/8"       | 3/8"      |
| 016368  | 3/8"       | 1/2"      |
| 016386  | 1/2"       | 3/8"      |
| 016388  | 1/2"       | 1/2"      |
| 016408  | 5/8"       | 1/2"      |

### Female Branch Tees



| Part # | Tube Size | Pipe Size |
|--------|-----------|-----------|
| 016415 | 1/4"      | 1/4"      |
| 016416 | 3/8"      | 1/8"      |
| 016417 | 3/8"      | 1/4"      |

### Composite Plugs



| Part # | Tube Size        |
|--------|------------------|
| 016115 | 1/4" (Pkg. of 5) |
| 016116 | 3/8" (Pkg. of 5) |
| 016117 | 1/2"             |

## BRASS PUSH-LOCK AIR BRAKE FITTINGS

- Designed for use with SAE J844 nylon tubing
- DOT 49CFR 571.106 compliant
- Fittings complies with worldwide Standard and Legislation including SAE J1131 "Hot Pull" requirements
- Operating temperatures from -40°F to +212°F
- Maximum operating pressure 0 to 150 psi
- Elbows and male branch fittings with built-in swivel for positioning
- Collet with multiple teeth for high grip on the tube
- Side load retention capabilities
- Positive release bushing for easy insertion and removal of tubing
- Thread sealant applied to all male pipe threads to reduce installation time and expense

### 45° Male Fixed Elbows

(Sealant applied)

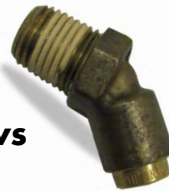

| Part # | Tube Size | Pipe Size |
|--------|-----------|-----------|
| 017980 | 1/4"      | 1/8"      |
| 017981 | 1/4"      | 1/4"      |
| 017982 | 3/8"      | 1/4"      |
| 017983 | 3/8"      | 3/8"      |
| 017984 | 1/2"      | 3/8"      |
| 017985 | 1/2"      | 1/2"      |

### 45° Male Swivel Elbows

(Sealant applied)



| Part # | Tube Size | Pipe Size |
|--------|-----------|-----------|
| 017991 | 1/4"      | 1/8"      |
| 017992 | 1/4"      | 1/4"      |
| 017993 | 3/8"      | 1/4"      |
| 017994 | 3/8"      | 3/8"      |
| 017995 | 1/2"      | 3/8"      |
| 017996 | 1/2"      | 1/2"      |

### Male Run Tees

(Sealant applied)



| Part # | Tube Size | Pipe Size |
|--------|-----------|-----------|
| 017900 | 1/4"      | 1/4"      |
| 017901 | 3/8"      | 1/4"      |
| 017902 | 3/8"      | 3/8"      |

### Male Branch Swivel Tees



| Part # | Tube Size | Pipe Size |
|--------|-----------|-----------|
| 017970 | 1/4"      | 1/8"      |
| 017972 | 3/8"      | 1/4"      |
| 017973 | 3/8"      | 3/8"      |
| 017974 | 1/2"      | 3/8"      |



Call the Velvac Sales Team: **800.783.8871** [sales@velvac.com](mailto:sales@velvac.com)

© VELVAC INC. • 2405 South Calhoun Road • New Berlin, WI 53151-2709 • Toll Free: 800.783.8871 • Fax: 262.786.4101

# FITTINGS & HARDWARE

## BRASS PUSH-LOCK AIR BRAKE FITTINGS

### Union Connectors



| Part # | Tube A | Tube B |
|--------|--------|--------|
| 017910 | 1/4"   | 1/4"   |
| 017911 | 3/8"   | 3/8"   |
| 017912 | 1/2"   | 1/2"   |
| 017913 | 5/8"   | 5/8"   |
| 017914 | 3/4"   | 3/4"   |

### 90° Male Swivel Elbows

(Sealant applied)



| Part # | Tube Size | Pipe Size |
|--------|-----------|-----------|
| 017950 | 1/4"      | 1/8"      |
| 017951 | 1/4"      | 1/4"      |
| 017952 | 1/4"      | 3/8"      |
| 017953 | 3/8"      | 1/8"      |
| 017954 | 3/8"      | 1/4"      |
| 017955 | 3/8"      | 3/8"      |
| 017956 | 3/8"      | 1/2"      |
| 017957 | 1/2"      | 1/4"      |
| 017958 | 1/2"      | 3/8"      |
| 017959 | 1/2"      | 1/2"      |

### Male Connectors

(Sealant applied)



| Part # | Tube Size | Pipe Size |
|--------|-----------|-----------|
| 017940 | 1/4"      | 1/8"      |
| 017941 | 1/4"      | 1/4"      |
| 017942 | 1/4"      | 3/8"      |
| 017943 | 3/8"      | 1/8"      |
| 017944 | 3/8"      | 1/4"      |
| 017945 | 3/8"      | 3/8"      |
| 017946 | 1/2"      | 3/8"      |
| 017947 | 1/2"      | 1/2"      |

### Union Tees



| Part # | Tube Size |
|--------|-----------|
| 017920 | 1/4"      |
| 017921 | 3/8"      |
| 017922 | 1/2"      |

### Union Elbows



| Part # | Tube Size |
|--------|-----------|
| 017931 | 3/8"      |
| 017932 | 1/2"      |

### 90° Male Non-Swivel Elbows

(Sealant applied)



| Part # | Tube Size | Pipe Size |
|--------|-----------|-----------|
| 017960 | 1/4"      | 1/8"      |
| 017961 | 1/4"      | 1/4"      |
| 017966 | 3/8"      | 1/8"      |
| 017962 | 3/8"      | 1/4"      |
| 017963 | 3/8"      | 3/8"      |
| 017967 | 1/2"      | 1/4"      |
| 017964 | 1/2"      | 3/8"      |
| 017965 | 1/2"      | 1/2"      |

### WARNING!

Velvac's line of push-lock brake fittings and tubing are designed only for use in vehicles where air is utilized as the operating fluid. As such, Velvac's push-lock air brake fittings should only be used in a manner consistent with the manufacturer's specifications.

Using Velvac's push-lock fittings or tubing improperly or in a manner inconsistent with the manufacturer's specifications may result in serious injury or property damage. For example, Velvac's push-lock fittings and tubing are not intended for use in environments exceeding 145 psi and only for temperatures between -45°F and +140°F. Velvac push-lock fittings and tubing are intended for use only as defined in 49CFR571.106.

Further, the U.S. Department of Transportation prohibits the use of push-lock fittings and nylon tubing as a connection between (I) a semi-tractor & trailer, or (II) a drive shaft and chassis.

## NYLON AIR BRAKE TUBE FITTINGS

- Designed for use with nylon air brake tubing
- DOT compliant. Fittings meet SAE J246 requirements
- Brass construction with internal stainless steel tube supports
- Pipe thread sealant featured on several fitting styles

- This pre-applied sealant offers many benefits:
  - » Provides no-leak assembly instantly. Saves application time and expense
  - » Will not contaminate systems such as tape shredding or liquid sealant washout
  - » Can be reused up to five times
  - » Provides excellent thread

### Bulkhead Unions



| Part # | Tube Size |
|--------|-----------|
| 016204 | 1/4"      |
| 016206 | 3/8"      |
| 016208 | 1/2"      |

**NOTE: Part numbers listed in RED are NEW!**

# FITTINGS & HARDWARE

## NYLON AIR BRAKE TUBE FITTINGS

### 45° Elbows (Sealant applied)



| Part # | Tube Size | Pipe Size |
|--------|-----------|-----------|
| 017842 | 1/4"      | 1/8"      |
| 017844 | 1/4"      | 1/4"      |
| 017862 | 3/8"      | 1/8"      |
| 017864 | 3/8"      | 1/4"      |
| 017866 | 3/8"      | 3/8"      |
| 017868 | 3/8"      | 1/2"      |
| 017886 | 1/2"      | 3/8"      |
| 017888 | 1/2"      | 1/2"      |
| 017884 | 1/2"      | 3/4"      |
| 017816 | 5/8"      | 3/8"      |
| 017808 | 5/8"      | 1/2"      |

### Female Connectors



| Part # | Tube Size | Pipe Size |
|--------|-----------|-----------|
| 016642 | 1/4"      | 1/8"      |
| 016644 | 1/4"      | 1/4"      |
| 016662 | 3/8"      | 1/8"      |
| 016664 | 3/8"      | 1/4"      |
| 016666 | 3/8"      | 3/8"      |
| 016686 | 1/2"      | 3/8"      |
| 016688 | 1/2"      | 1/2"      |
| 016618 | 5/8"      | 1/2"      |
| 017816 | 5/8"      | 3/8"      |
| 017808 | 5/8"      | 1/2"      |

### Tee Thread Branches (Sealant applied)



| Part # | Tube Size | Pipe Size |
|--------|-----------|-----------|
| 017242 | 1/4"      | 1/8"      |
| 017244 | 1/4"      | 1/4"      |
| 017262 | 3/8"      | 1/8"      |
| 017264 | 3/8"      | 1/4"      |
| 017266 | 3/8"      | 3/8"      |
| 017286 | 1/2"      | 3/8"      |
| 017288 | 1/2"      | 1/2"      |
| 017218 | 5/8"      | 1/2"      |

### Male Elbows



| Part # | Tube Size | Pipe Size |
|--------|-----------|-----------|
| 016942 | 1/4"      | 1/8"      |
| 016944 | 1/4"      | 1/4"      |
| 016946 | 1/4"      | 3/8"      |
| 016962 | 3/8"      | 1/8"      |
| 016964 | 3/8"      | 1/4"      |
| 016966 | 3/8"      | 3/8"      |
| 016968 | 3/8"      | 1/2"      |
| 016984 | 1/2"      | 1/4"      |
| 016986 | 1/2"      | 3/8"      |
| 016988 | 1/2"      | 1/2"      |
| 016916 | 5/8"      | 3/8"      |
| 016908 | 5/8"      | 1/2"      |
| 016912 | 5/8"      | 3/4"      |
| 016918 | 3/4"      | 1/2"      |
| 016922 | 3/4"      | 3/4"      |

### Elbow End Tubes



| Part # | Tube Size |
|--------|-----------|
| 016540 | 1/4"      |
| 016560 | 3/8"      |
| 016580 | 1/2"      |
| 016510 | 5/8"      |

### Male Connectors (Sealant applied)



| Part # | Tube Size | Pipe Size |
|--------|-----------|-----------|
| 016842 | 1/4"      | 1/8"      |
| 016844 | 1/4"      | 1/4"      |
| 016846 | 1/4"      | 3/8"      |
| 016862 | 3/8"      | 1/8"      |
| 016864 | 3/8"      | 1/4"      |
| 016866 | 3/8"      | 3/8"      |
| 016868 | 3/8"      | 1/2"      |
| 016884 | 1/2"      | 1/4"      |
| 016886 | 1/2"      | 3/8"      |
| 016888 | 1/2"      | 1/2"      |
| 016890 | 1/2"      | 3/4"      |
| 016806 | 5/8"      | 3/8"      |
| 016808 | 5/8"      | 1/2"      |
| 016809 | 5/8"      | 3/4"      |
| 016818 | 3/4"      | 1/2"      |
| 016811 | 3/4"      | 3/4"      |

#### Helpful hint

Air brake hose repair fitting kits are part numbers 500007 and 500008



Call the Velvac Sales Team: **800.783.8871** sales@velvac.com

© VELVAC INC. • 2405 South Calhoun Road • New Berlin, WI 53151-2709 • Toll Free: 800.783.8871 • Fax: 262.786.4101



# FITTINGS & HARDWARE

## NYLON AIR BRAKE TUBE FITTINGS

### Female Elbows



| Part # | Tube Size | Pipe Size |
|--------|-----------|-----------|
| 017043 | 1/4"      | 1/8"      |
| 017046 | 1/4"      | 1/4"      |
| 017064 | 3/8"      | 1/4"      |
| 017066 | 3/8"      | 3/8"      |
| 017086 | 1/2"      | 3/8"      |

### Tee Thread Runs



| Part # | Tube Size | Pipe Size |
|--------|-----------|-----------|
| 017142 | 1/4"      | 1/8"      |
| 017144 | 1/4"      | 1/4"      |
| 017164 | 3/8"      | 1/4"      |
| 017166 | 3/8"      | 3/8"      |
| 017186 | 1/2"      | 3/8"      |
| 017188 | 1/2"      | 1/2"      |

### Tee End Tubes

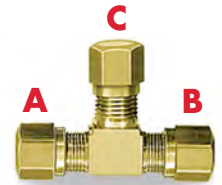

| Part # | Tube Size          |
|--------|--------------------|
| 016440 | 1/4"               |
| 016460 | 3/8"               |
| 016482 | A, B: 3/8" C: 1/4" |
| 016480 | 1/2"               |
| 016481 | 5/8"               |

### Full Unions



| Part # | Tube Size |
|--------|-----------|
| 016240 | 1/4"      |
| 016260 | 3/8"      |
| 016280 | 1/2"      |
| 016200 | 5/8"      |
| 016201 | 3/4"      |

### Sleeves



| Part # | Tube Size |
|--------|-----------|
| 016340 | 1/4"      |
| 016360 | 3/8"      |
| 016380 | 1/2"      |
| 016300 | 5/8"      |
| 016301 | 3/4"      |

### Nuts



| Part # | Tube Size |
|--------|-----------|
| 016140 | 1/4"      |
| 016160 | 3/8"      |
| 016180 | 1/2"      |
| 016100 | 5/8"      |
| 016101 | 3/4"      |

## AIR BRAKE COMPRESSION FITTINGS

- Designed for use with nylon or copper air brake tubing
- DOT compliant. Fittings meet SAE J246 requirements
- All brass construction
- Pipe thread sealant featured on several fitting styles. This pre-applied sealant offers many benefits:
  - » Provides no-leak assembly instantly. Saves application time and expense
  - » Will not contaminate systems such as tape shredding or liquid sealant
  - » Can be reused up to five times
  - » Provides excellent thread lubrication to prevent galling

### 45° Male Elbows

(Sealant applied)



| Part # | Tube Size | Pipe Size |
|--------|-----------|-----------|
| 013075 | 3/8"      | 1/4"      |
| 013076 | 3/8"      | 3/8"      |
| 013077 | 1/2"      | 3/8"      |

### Male Elbows

(Sealant applied)



| Part # | Tube Size | Pipe Size |
|--------|-----------|-----------|
| 012067 | 1/4"      | 1/8"      |
| 012071 | 1/4"      | 1/4"      |
| 012073 | 1/4"      | 3/8"      |
| 012087 | 3/8"      | 1/8"      |
| 012091 | 3/8"      | 1/4"      |
| 012093 | 3/8"      | 3/8"      |
| 012095 | 3/8"      | 1/2"      |
| 012097 | 1/2"      | 1/4"      |
| 013001 | 1/2"      | 3/8"      |
| 013003 | 1/2"      | 1/2"      |
| 013011 | 5/8"      | 1/2"      |

### Compression Nuts



| Part # | Tube Size |
|--------|-----------|
| 011013 | 1/4"      |
| 011023 | 3/8"      |
| 011025 | 1/2"      |
| 011027 | 5/8"      |

# FITTINGS & HARDWARE

## AIR BRAKE COMPRESSION FITTINGS

### Full Unions



| Part # | Tube Size |
|--------|-----------|
| 011033 | 1/4"      |
| 011041 | 3/8"      |
| 011043 | 1/2"      |
| 011045 | 5/8"      |
| 011047 | 3/4"      |

### Nylon Tubing Inserts



| Part # | Tube Size |
|--------|-----------|
| 010087 | 1/4"      |
| 010089 | 3/8"      |
| 010094 | 1/2"      |
| 010096 | 5/8"      |
| 010098 | 3/4"      |

### Female Connectors



| Part # | Tube Size | Pipe Size |
|--------|-----------|-----------|
| 011093 | 3/8"      | 1/4"      |

### Tee Thread Branches



| Part # | Tube Size |
|--------|-----------|
| 011051 | 1/4"      |
| 011057 | 3/8"      |
| 011059 | 1/2"      |

### Tee Thread Runs



| Part # | Tube Size | Pipe Size |
|--------|-----------|-----------|
| 013041 | 3/8"      | 1/4"      |

### Spherical Sleeves



| Part # | Tube Size |
|--------|-----------|
| 011001 | 1/4"      |
| 011003 | 3/8"      |
| 011005 | 1/2"      |
| 011007 | 5/8"      |
| 011009 | 3/4"      |

Fitting sleeves should NEVER be reused

### Male Connectors (Sealant applied)



| Part # | Tube Size | Pipe Size |
|--------|-----------|-----------|
| 012017 | 1/4"      | 1/8"      |
| 012021 | 1/4"      | 1/4"      |
| 012023 | 1/4"      | 3/8"      |
| 012035 | 3/8"      | 1/8"      |
| 012037 | 3/8"      | 1/4"      |
| 012041 | 3/8"      | 3/8"      |
| 012043 | 3/8"      | 1/2"      |
| 012045 | 1/2"      | 1/4"      |
| 012047 | 1/2"      | 3/8"      |
| 012049 | 1/2"      | 1/2"      |
| 012053 | 5/8"      | 3/8"      |
| 012055 | 5/8"      | 1/2"      |
| 012061 | 3/4"      | 1/2"      |

### Tee Thread Branches (Sealant applied)



| Part # | Tube Size | Pipe Size |
|--------|-----------|-----------|
| 013049 | 1/4"      | 1/8"      |
| 013057 | 3/8"      | 1/4"      |
| 013060 | 3/8"      | 3/8"      |

## RE-USABLE AIR HOSE FITTINGS

- Designed for use with rubber air brake hose
- Bodies, sleeves and nuts are all brass construction for durability and corrosion resistance
- Zinc-plated steel springs have rounded ends to protect air hose

### Fitting Assemblies



| Part # | Hose I.D. | Pipe Size |
|--------|-----------|-----------|
| 500001 | 3/8"      | 1/2"      |
| 500009 | 3/8"      | 3/8"      |
| 500015 | 3/8"      | 1/4"      |
| 500050 | 1/2"      | 1/2"      |
| 500051 | 1/2"      | 3/8"      |

### Swivel Fitting Assemblies



| Part # | Hose I.D. | Pipe Size |
|--------|-----------|-----------|
| 500039 | 3/8"      | 1/4"      |
| 500046 | 3/8"      | 3/8"      |
| 500044 | 3/8"      | 1/2"      |
| 500094 | 1/2"      | 3/8"      |



Call the Velvac Sales Team: **800.783.8871** sales@velvac.com

© VELVAC INC. • 2405 South Calhoun Road • New Berlin, WI 53151-2709 • Toll Free: 800.783.8871 • Fax: 262.786.4101

# FITTINGS & HARDWARE

## RE-USABLE AIR HOSE FITTINGS

### Nuts (w/ or w/o spring)



| Part # | Type         | Hose I.D. |
|--------|--------------|-----------|
| 500021 | Spring & Nut | 3/8"      |
| 500071 | Spring & Nut | 1/2"      |
| 500037 | Nut Only     | 1/2"      |
| 500022 | Nut Only     | 3/8"      |
| 500030 | Spring Only  | 1/2"      |
| 500024 | Spring Only  | 3/8"      |

### Nuts



| Part # | Hose I.D. |
|--------|-----------|
| 500004 | 3/8"      |
| 500054 | 1/2"      |

### Union Assemblies



| Part # | Hose I.D. |
|--------|-----------|
| 500031 | 3/8"      |
| 500088 | 1/2"      |

### Fitting Sleeves



| Part # | Hose I.D. |
|--------|-----------|
| 500005 | 3/8"      |
| 500055 | 1/2"      |

Fitting sleeves should NEVER be reused

### Union Bodies



| Part # | Tube Size |
|--------|-----------|
| 500033 | 3/8"      |
| 500041 | 1/2"      |

### Fitting Assemblies (w/ spring)



| Part # | Hose I.D. | Pipe Size |
|--------|-----------|-----------|
| 500019 | 3/8"      | 1/2"      |
| 500025 | 3/8"      | 3/8"      |
| 500027 | 3/8"      | 1/4"      |
| 500070 | 1/2"      | 1/2"      |
| 500078 | 1/2"      | 3/8"      |

### Swivel Body Adaptors



| Part # | Hose I.D. | Pipe Size | Straight Thread |
|--------|-----------|-----------|-----------------|
| 140000 | 3/8"      | 1/4"      | 3/4" - 20       |
| 142001 | 3/8"      | 3/8"      | 3/4" - 20       |
| 500059 | 3/8"      | 1/2"      | 3/4" - 20       |
| 500052 | 1/2"      | 3/8"      | 7/8" - 20       |
| 500060 | 1/2"      | 1/2"      | 7/8" - 20       |

### Dual Barb Male Fitting (Sealant applied)



| Part # | Hose Size | Tube Size |
|--------|-----------|-----------|
| 500079 | 1/4"      | 1/8"      |
| 500080 | 1/4"      | 1/4"      |
| 500081 | 5/16"     | 1/4"      |
| 500082 | 3/8"      | 1/4"      |
| 500083 | 3/8"      | 3/8"      |
| 500084 | 5/8"      | 1/2"      |
| 500085 | 3/4"      | 3/4"      |

### Firewall Couplings

- Zinc-plated steel construction
- 1/4" FPT both ends
- 3/16" diameter mounting holes on 1-3/8" centers



| Part # | Description       |
|--------|-------------------|
| 501071 | Firewall coupling |

### Swivel Fitting Assemblies (w/ spring)



| Part # | Hose I.D. | Pipe Size |
|--------|-----------|-----------|
| 500035 | 3/8"      | 1/4"      |
| 500042 | 3/8"      | 3/8"      |

### Hose Splicers



| Part # | Hose Size |
|--------|-----------|
| 500063 | 3/8"      |
| 500064 | 1/2"      |
| 500065 | 5/8"      |
| 500066 | 3/4"      |

### Fitting Bodies



| Part # | Hose I.D. | Pipe Size |
|--------|-----------|-----------|
| 500003 | 3/8"      | 1/2"      |
| 500011 | 3/8"      | 3/8"      |
| 500017 | 3/8"      | 1/4"      |
| 500053 | 1/2"      | 1/2"      |
| 500061 | 1/2"      | 3/8"      |

### Frame Couplings

- Zinc-plated steel construction
- FPT both ends



| Part # | Frame | Overall Length | Thread    |
|--------|-------|----------------|-----------|
| 035081 | 1/4"  | 1-1/2"         | 3/4" - 16 |
| 035087 | 3/8"  | 1-3/8"         | 1" - 14   |

# FITTINGS & HARDWARE

## CLAMPING STUDS

### Male Clamping Studs



- Zinc-plated steel construction
- 1/2" MPT each end, 1/4" FPT one end
- 1" - 14 mounting thread
- 2-3/8" overall length

| Part # | Description        |
|--------|--------------------|
| 035021 | Male clamping stud |

### Female Clamping Studs



- Zinc-plated steel construction
- 1/2" MPT, 1/4" FPT one end and 1/2" FPT other end
- 1-1/4" mounting thread
- 2-1/4" overall length

| Part # | Description          |
|--------|----------------------|
| 035029 | Female clamping stud |

### Frame Clamping Studs



- Zinc-plated steel construction
- 1/2" MPT one end, 3/8" FPT one end
- 1-1/4" mounting thread
- 1-7/8" overall length

| Part # | Description        |
|--------|--------------------|
| 035079 | Male clamping stud |

### Bulkhead Fittings: Female to Nylon Tubing

- 3/8" NPTF thread



| Part # | Tube Size |
|--------|-----------|
| 017098 | 1/2"      |
| 017099 | 3/8"      |

### Bulkhead Fittings with Spring



| Part # | Tube Size |
|--------|-----------|
| 500096 | 3/8"      |

## VACUUM HOSE FITTINGS

### Nipples



| Part # | Hose Size | Tube Size |
|--------|-----------|-----------|
| 149005 | 1/2"      | 1/2"      |
| 149006 | 3/4"      | 1/2"      |

## DISCHARGE HOSE FITTINGS

- Designed for use with stainless steel braided discharge hose
- All brass bodies with brass sleeves and steel nuts

### Fitting Sleeves



| 5/8" O.D. Part # | 3/4" O.D. Part # | Type   |
|------------------|------------------|--------|
| 142104           | -                | Sleeve |
| 142108           | 142109           | Nut    |

### Straight Tubes



| Part # | Hose O.D. |
|--------|-----------|
| 142102 | 5/8"      |
| 142103 | 3/4"      |

### Male Pipe Fittings



| Part # | Hose O.D. | Pipe Thread |
|--------|-----------|-------------|
| 142101 | 5/8"      | 1/2" - 14   |

### Compression Fittings



| Part # | Hose O.D. | Male Thread |
|--------|-----------|-------------|
| 142106 | 5/8"      | 13/16" - 18 |
| 142107 | 3/4"      | 1" - 18     |

### Female Swivel Fittings



| Part # | Hose O.D. | Female Thread |
|--------|-----------|---------------|
| 142110 | 5/8"      | 7/8" - 14     |
| 142111 | 3/4"      | 1-1/16" - 14  |



Call the Velvac Sales Team: **800.783.8871** sales@velvac.com

© VELVAC INC. • 2405 South Calhoun Road • New Berlin, WI 53151-2709 • Toll Free: 800.783.8871 • Fax: 262.786.4101

# FITTINGS & HARDWARE

## FULLER TRANSMISSION COMPRESSION FITTINGS

- Designed for use with polyethylene nylon and plastic tubing  
NOT FOR AIR BRAKE USE
- All brass construction

### Sleeves



| Part # | Tube Size |
|--------|-----------|
| 010093 | 3/16"     |

### Male Connectors



| Part # | Tube Size | Pipe Size |
|--------|-----------|-----------|
| 012016 | 1/8"      | 1/16"     |
| 012015 | 3/16"     | 1/8"      |
| 012012 | 5/32"     | 1/16"     |
| 012014 | 5/32"     | 1/8"      |
| 012022 | 1/8"      | 1/8"      |

### Male Elbows



| Part # | Tube Size | Pipe Size |
|--------|-----------|-----------|
| 012069 | 1/8"      | 1/8"      |
| 012064 | 5/32"     | 1/8"      |
| 012066 | 1/8"      | 1/8"      |
| 012068 | 3/16"     | 1/8"      |

### Nuts



| Part # | Tube Size |
|--------|-----------|
| 011012 | 1/8"      |
| 011014 | 3/16"     |
| 011016 | 5/32"     |

### Slotted Collets



| Part # | Tube Size |
|--------|-----------|
| 011000 | 1/8"      |
| 011020 | 5/32"     |

### Insert



| Part # | Tube Size |
|--------|-----------|
| 010085 | 3/16"     |

### Full Unions



| Part # | Tube Size |
|--------|-----------|
| 011032 | 1/8"      |
| 011034 | 5/32"     |

## INVERTED FLARE FITTINGS

- Designed for use with flareable copper, brass, aluminum and welded steel hydraulic tubing
- All brass construction (unless otherwise noted)
- UL compliant for flammable liquid and gas
- Fittings meet SAE J246 requirements
- DOT compliant

### Male Connectors



| Part # | Tube Size | Pipe Size | Straight Thread |
|--------|-----------|-----------|-----------------|
| 006842 | 1/4"      | 1/8"      | 7/16" - 24      |
| 006852 | 5/16"     | 1/8"      | 1/2" - 20       |
| 006854 | 5/16"     | 1/4"      | 1/2" - 20       |
| 006864 | 3/8"      | 1/4"      | 5/8" - 18       |
| 006866 | 3/8"      | 3/8"      | 5/8" - 18       |
| 006886 | 1/2"      | 3/8"      | 3/4" - 18       |

### Male Elbows



| Part # | Tube Size | Pipe Size | Straight Thread |
|--------|-----------|-----------|-----------------|
| 006942 | 1/4"      | 1/8"      | 7/16" - 24      |

### Nuts



- Brass construction

| Part # | Tube Size | Straight Thread |
|--------|-----------|-----------------|
| 006103 | 3/16"     | 3/8" - 24       |
| 006104 | 1/4"      | 7/16" - 24      |
| 006106 | 3/8"      | 5/8" - 10       |

- Plated steel construction

| Part # | Tube Size | Straight Thread |
|--------|-----------|-----------------|
| 006304 | 1/4"      | 7/16" - 24      |
| 006305 | 5/16"     | 1/2" - 24       |

### Female Connectors



| Part # | Tube Size | Pipe Size | Straight Thread |
|--------|-----------|-----------|-----------------|
| 006642 | 1/4"      | 1/8"      | 7/16" - 24      |
| 006664 | 3/8"      | 1/4"      | 5/8" - 18       |

### Unions



| Part # | Tube Size | Straight Thread |
|--------|-----------|-----------------|
| 006203 | 3/16"     | 3/8" - 24       |
| 006204 | 1/4"      | 7/16" - 24      |
| 006205 | 5/16"     | 1/2" - 20       |
| 006206 | 3/8"      | 5/8" - 18       |

# FITTINGS & HARDWARE

## PIPE FITTINGS

### Pipe Crosses



| Part # | Pipe Size | Material |
|--------|-----------|----------|
| 017075 | 1/4"      | Brass    |
| 017077 | 3/8"      | Brass    |
| 017078 | 1/2"      | Brass    |

### Close Nipples



| Part # | Pipe Size | Material       |
|--------|-----------|----------------|
| 016051 | 1/8"      | Brass          |
| 016052 | 1/4"      | Brass          |
| 016053 | 3/8"      | Brass          |
| 016054 | 1/2"      | Brass          |
| 016065 | 3/4"      | Malleable iron |

### Caps

(Female Pipe Fittings)



| Part # | Pipe Size |
|--------|-----------|
| 017223 | 1/8"      |
| 017224 | 1/4"      |
| 017225 | 3/8"      |
| 017226 | 1/2"      |
| 017227 | 3/4"      |

### Hex Nipples



| Part # | Pipe Size | Material     |
|--------|-----------|--------------|
| 018009 | 1/8"      | Brass        |
| 018010 | 1/4"      | Brass        |
| 018011 | 3/8"      | Brass        |
| 018012 | 1/2"      | Brass        |
| 018023 | 3/4"      | Plated steel |

### Male Branch Tees



| Part # | Pipe Size | Material |
|--------|-----------|----------|
| 016014 | 1/8"      | Brass    |
| 016015 | 1/4"      | Brass    |
| 016016 | 3/8"      | Brass    |
| 016017 | 1/2"      | Brass    |

### Pipe Elbows



| Part # | Pipe Size | Material |
|--------|-----------|----------|
| 017003 | 1/8"      | Brass    |
| 017004 | 1/4"      | Brass    |
| 017005 | 3/8"      | Brass    |
| 017006 | 1/2"      | Brass    |

### 45° Street Elbows



| Part # | Pipe Size | Material |
|--------|-----------|----------|
| 017023 | 1/8"      | Brass    |
| 017025 | 1/4"      | Brass    |
| 017027 | 3/8"      | Brass    |
| 017029 | 1/2"      | Brass    |

### Pipe Tees



| Part # | Pipe Size | Material |
|--------|-----------|----------|
| 016001 | 1/8"      | Brass    |
| 016002 | 1/4"      | Brass    |
| 016003 | 3/8"      | Brass    |
| 016004 | 1/2"      | Brass    |
| 016005 | 3/4"      | Brass    |

### Pipe Nipples



• Brass

| Part # | Pipe Size | Length |
|--------|-----------|--------|
| 016021 | 1/8"      | 1-1/2" |
| 016025 | 1/4"      | 1-1/2" |
| 016029 | 3/8"      | 1-1/2" |
| 016033 | 1/2"      | 1-1/2" |
| 016044 | 1/4"      | 2 1/2" |
| 016045 | 3/8"      | 2 1/2" |
| 016046 | 3/8"      | 3"     |
| 016047 | 3/4"      | 2 1/2" |

• Malleable Iron

| Part # | Pipe Size | Length |
|--------|-----------|--------|
| 016037 | 1/8"      | 2"     |
| 016038 | 1/4"      | 2"     |
| 016039 | 3/8"      | 2"     |
| 016040 | 1/2"      | 2"     |
| 016041 | 1/2"      | 3"     |
| 016042 | 3/4"      | 2"     |
| 016043 | 3/4"      | 3"     |

### Reducer Bushings



• Brass

| Part # | Pipe Size   | Material       |
|--------|-------------|----------------|
| 016079 | 1/4" x 1/8" | Brass          |
| 016089 | 1/4" x 1"   | Brass          |
| 016080 | 3/8" x 1/8" | Brass          |
| 016081 | 3/8" x 1/4" | Brass          |
| 016082 | 1/2" x 1/8" | Brass          |
| 016083 | 1/2" x 1/4" | Brass          |
| 016084 | 1/2" x 3/8" | Brass          |
| 016088 | 1/2" x 1"   | Brass          |
| 016085 | 3/4" x 1/4" | Brass          |
| 016086 | 3/4" x 3/8" | Brass          |
| 016087 | 3/4" x 1/2" | Brass          |
| 017000 | 1" x 3/4"   | Malleable iron |



Call the Velvac Sales Team: **800.783.8871** [sales@velvac.com](mailto:sales@velvac.com)

© VELVAC INC. • 2405 South Calhoun Road • New Berlin, WI 53151-2709 • Toll Free: 800.783.8871 • Fax: 262.786.4101

### Street Tees



| Part # | Pipe Size | Material       |
|--------|-----------|----------------|
| 017091 | 1/8"      | Brass          |
| 017093 | 1/4"      | Malleable iron |
| 017095 | 3/8"      | Malleable iron |
| 017096 | 1/2"      | Malleable iron |
| 017094 | 3/4"      | Brass          |

### Street Elbows

- Brass construction



| Part # | Pipe Size   | Material |
|--------|-------------|----------|
| 017015 | 1/8"        | Brass    |
| 017039 | 1/4" x 1/8" | Brass    |
| 017017 | 1/4"        | Brass    |
| 017019 | 3/8"        | Brass    |
| 017021 | 1/2"        | Brass    |
| 017031 | 3/4"        | Brass    |

### Hex Head Plugs



| Part # | Pipe Size | Material |
|--------|-----------|----------|
| 017051 | 1/8"      | Brass    |
| 017053 | 1/4"      | Brass    |
| 017055 | 3/8"      | Brass    |
| 017057 | 1/2"      | Brass    |
| 017056 | 3/4"      | Brass    |
| 017058 | 1"        | Brass    |

### Square Head Plugs



| Part # | Pipe Size | Material |
|--------|-----------|----------|
| 017061 | 1/8"      | Brass    |
| 017063 | 1/4"      | Brass    |
| 017065 | 3/8"      | Brass    |
| 017067 | 1/2"      | Brass    |
| 017069 | 3/4"      | Brass    |
| 017059 | 3/4"      | Brass    |
| 017072 | 1"        | Brass    |

### Reducer Couplings



| Part # | Pipe Size   | Material |
|--------|-------------|----------|
| 017081 | 1/4" x 1/8" | Brass    |
| 017083 | 3/8" x 1/4" | Brass    |
| 017089 | 1/2" x 1/4" | Brass    |
| 017085 | 1/2" x 3/8" | Brass    |
| 017090 | 3/4" x 1/2" | Brass    |

### Reducer Hex Nipples



| Part # | Pipe Size   | Material     |
|--------|-------------|--------------|
| 018013 | 1/4" x 1/8" | Brass        |
| 018030 | 3/8" x 1/8" | Brass        |
| 018025 | 3/8" x 1/4" | Plated steel |
| 018026 | 1/2" x 1/4" | NPTF         |
| 018027 | 1/2" x 3/8" | Plated steel |
| 018029 | 3/4" x 1/2" | Plated steel |

### Counter-Sunk Plugs



| Part # | Pipe Size | Material |
|--------|-----------|----------|
| 017106 | 1/8"      | Brass    |
| 017107 | 1/4"      | Brass    |
| 017108 | 3/8"      | Brass    |
| 017109 | 1/2"      | Brass    |
| 017110 | 3/4"      | Brass    |

### Couplings



| Part # | Pipe Size | Material       |
|--------|-----------|----------------|
| 016067 | 1/8"      | Brass          |
| 016068 | 1/4"      | Brass          |
| 016069 | 3/8"      | Brass          |
| 016070 | 1/2"      | Brass          |
| 016077 | 3/4"      | Malleable iron |

### Adapters



| Part # | Pipe Size   | Material |
|--------|-------------|----------|
| 018034 | 1/8" x 1/8" | Brass    |
| 018006 | 1/4" x 1/8" | Brass    |
| 018035 | 1/4" x 1/4" | Brass    |
| 018007 | 3/8" x 1/4" | Brass    |
| 018036 | 3/8" x 1/8" | Brass    |
| 018037 | 3/8" x 3/8" | Brass    |
| 018008 | 1/2" x 3/8" | Brass    |
| 018038 | 3/4" x 1/2" | Brass    |

### Slotted Plugs



| Part # | Pipe Size | Material |
|--------|-----------|----------|
| 017101 | 1/8"      | Brass    |
| 017102 | 1/4"      | Brass    |
| 017103 | 3/8"      | Brass    |

# FITTINGS & HARDWARE

## SAE 45° FLARE FITTINGS

- Designed for use with flareable copper, brass, aluminum and welded steel hydraulic tubing
- All brass construction
- UL compliant for flammable liquid and gas
- Fittings meet SAE J246 requirements

### Hose Barb to Female Flare Swivels



| Part # | Tube Size | Hose Size |
|--------|-----------|-----------|
| 016945 | 3/8"      | 3/8"      |
| 016948 | 1/4"      | 1/4"      |

### Male Connectors



| Part # | Tube Size | Pipe Size | Straight Thread |
|--------|-----------|-----------|-----------------|
| 014822 | 1/8"      | 1/8"      | 5/16" - 24      |
| 014832 | 3/16"     | 1/8"      | 3/8" - 24       |
| 014842 | 1/4"      | 1/8"      | 7/16" - 20      |
| 014844 | 1/4"      | 1/4"      | 7/16" - 20      |
| 014210 | 1/4"      | 3/8"      | 7/16" - 20      |
| 014211 | 3/8"      | 3/4"      | 5/8" - 18       |
| 014852 | 5/16"     | 1/8"      | 1/2" - 20       |
| 014854 | 5/16"     | 1/4"      | 1/2" - 20       |
| 014862 | 3/8"      | 1/8"      | 5/8" - 18       |
| 014864 | 3/8"      | 1/4"      | 5/8" - 18       |
| 014866 | 3/8"      | 3/8"      | 5/8" - 18       |
| 014868 | 3/8"      | 1/2"      | 5/8" - 18       |
| 014884 | 1/2"      | 1/4"      | 3/4" - 16       |
| 014886 | 1/2"      | 3/8"      | 3/4" - 16       |
| 014212 | 5/8"      | 3/4"      | 7/8" - 14       |
| 014888 | 1/2"      | 1/2"      | 3/4" - 16       |
| 014806 | 5/8"      | 3/8"      | 7/8" - 14       |
| 014808 | 5/8"      | 1/2"      | 7/8" - 14       |
| 014818 | 3/4"      | 1/2"      | 1-1/16"-14      |
| 014811 | 3/4"      | 3/4"      | 1-1/16"-14      |

### Unions



| Part # | Tube Size | Straight Thread |
|--------|-----------|-----------------|
| 014204 | 1/4"      | 7/16" - 20      |
| 014206 | 3/8"      | 5/8" - 18       |
| 014208 | 1/2"      | 3/4" - 16       |
| 014200 | 5/8"      | 7/8" - 14       |
| 014209 | 3/4"      | 1 1/16" - 14    |

### Male Elbows



| Part # | Tube Size | Pipe Size | Straight Thread |
|--------|-----------|-----------|-----------------|
| 014942 | 1/4"      | 1/8"      | 7/16" - 20      |
| 014944 | 1/4"      | 1/4"      | 7/16" - 20      |
| 014946 | 1/4"      | 3/8"      | 7/16" - 20      |
| 014952 | 5/16"     | 1/8"      | 1/2" - 20       |
| 014962 | 3/8"      | 1/8"      | 5/8" - 18       |
| 014964 | 3/8"      | 1/4"      | 5/8" - 18       |
| 014966 | 3/8"      | 3/8"      | 5/8" - 18       |
| 014968 | 3/8"      | 1/2"      | 5/8" - 18       |
| 014984 | 1/2"      | 1/4"      | 3/4" - 16       |
| 014986 | 1/2"      | 3/8"      | 3/4" - 16       |
| 014988 | 1/2"      | 1/2"      | 3/4" - 16       |
| 014906 | 5/8"      | 3/8"      | 7/8" - 14       |
| 014908 | 5/8"      | 1/2"      | 7/8" - 14       |
| 014918 | 3/4"      | 1/2"      | 1-1/16"-14      |
| 014911 | 3/4"      | 3/4"      | 1-1/16"-14      |

### 45° Elbows



| Part # | Tube Size | Pipe Size | Straight Thread |
|--------|-----------|-----------|-----------------|
| 015942 | 1/4"      | 1/8"      | 7/16" - 20      |
| 015944 | 1/4"      | 1/4"      | 7/16" - 20      |
| 015964 | 3/8"      | 1/4"      | 5/8" - 18       |
| 015966 | 3/8"      | 3/8"      | 5/8" - 18       |
| 015986 | 1/2"      | 3/8"      | 3/4" - 16       |
| 015988 | 1/2"      | 1/2"      | 3/4" - 16       |
| 015906 | 5/8"      | 3/8"      | 7/8" - 14       |
| 015908 | 5/8"      | 1/2"      | 7/8" - 14       |

### Long Nuts



| Part # | Tube Size | Straight Thread |
|--------|-----------|-----------------|
| 014106 | 3/8"      | 5/8" - 18       |

### Cap Nuts



| Part # | Tube Size | Straight Thread |
|--------|-----------|-----------------|
| 014216 | 3/8"      | 5/8" - 18       |
| 014217 | 1/2"      | 3/4" - 16       |
| 014218 | 5/8"      | 7/8" - 14       |



Call the Velvac Sales Team: **800.783.8871** sales@velvac.com

© VELVAC INC. • 2405 South Calhoun Road • New Berlin, WI 53151-2709 • Toll Free: 800.783.8871 • Fax: 262.786.4101



# FITTINGS & HARDWARE

## INVERTED FLARE FITTINGS

- Designed for use with flareable copper, brass, aluminum and welded steel hydraulic tubing
- All brass construction (unless otherwise noted)
- UL compliant for flammable liquid and gas
- Fittings meet SAE J246 requirements
- DOT compliant

### Male Connectors



| Part # | Tube Size | Pipe Size | Straight Thread |
|--------|-----------|-----------|-----------------|
| 006842 | 1/4"      | 1/8"      | 7/16" - 24      |
| 006852 | 5/16"     | 1/8"      | 1/2" - 20       |
| 006854 | 5/16"     | 1/4"      | 1/2" - 20       |
| 006864 | 3/8"      | 1/4"      | 5/8" - 18       |
| 006866 | 3/8"      | 3/8"      | 5/8" - 18       |
| 006886 | 1/2"      | 3/8"      | 3/4" - 18       |

### Female Connectors



| Part # | Tube Size | Pipe Size | Straight Thread |
|--------|-----------|-----------|-----------------|
| 006642 | 1/4"      | 1/8"      | 7/16" - 24      |
| 006664 | 3/8"      | 1/4"      | 5/8" - 18       |

### Nuts



| Part # | Tube Size | Straight Thread | Material     |
|--------|-----------|-----------------|--------------|
| 006103 | 3/16"     | 3/8" - 24       | Brass        |
| 006104 | 1/4"      | 7/16" - 24      | Brass        |
| 006106 | 3/8"      | 5/8" - 10       | Brass        |
| 006304 | 1/4"      | 7/16" - 24      | Plated steel |
| 006305 | 5/16"     | 5/16" - 24      | Plated steel |

### Unions



| Part # | Tube Size | Straight Thread |
|--------|-----------|-----------------|
| 006203 | 3/16"     | 3/8" - 24       |
| 006204 | 1/4"      | 7/16" - 24      |
| 006205 | 5/16"     | 1/2" - 20       |
| 006206 | 3/8"      | 5/8" - 18       |

### Male Elbows



| Part # | Tube Size | Pipe Size | Straight Thread |
|--------|-----------|-----------|-----------------|
| 006942 | 1/4"      | 1/8"      | 7/16" - 24      |

## TRUCK & TRAILER REPAIR KITS

### Transmission Air Line Repair Kit

- 11 total fittings

| Part # | Description                 | Qty. |
|--------|-----------------------------|------|
| 016112 | 1/8 x 1/8" Male connector   | 1    |
| 016120 | 5/32 x 1/16" Male connector | 2    |
| 016122 | 5/32 x 1/8" Male connector  | 2    |
| 016212 | 1/8 x 1/8" Male connector   | 1    |
| 016222 | 5/32 x 1/8" Male connector  | 1    |
| 016610 | 1/8" Union                  | 1    |
| 016620 | 5/32" Union                 | 1    |
| 016630 | 3/16" Union                 | 1    |
| 090028 | Nylon tube cutter           | 1    |

### Nylon Air Brake Tube Fitting Kit

- 33 total fittings

| Part # | Description               | Qty. |
|--------|---------------------------|------|
| 016240 | 1/4" Full union           | 2    |
| 016260 | 3/8" Full union           | 2    |
| 016280 | 1/2" Full union           | 2    |
| 016200 | 5/8" Full union           | 2    |
| 016842 | 1/4 x 1/8" Male connector | 2    |
| 016844 | 1/4 x 1/4" Male connector | 3    |
| 016864 | 3/8 x 1/4" Male connector | 2    |
| 016866 | 3/8 x 3/8" Male connector | 1    |

**NOTE:** See next page for kit part numbers

| Part # | Description               | Qty. |
|--------|---------------------------|------|
| 016886 | 1/2 x 3/8" Male connector | 1    |
| 016942 | 1/4 x 1/8" Male elbow     | 2    |
| 016944 | 1/4 x 1/4" Male elbow     | 3    |
| 016964 | 3/8 x 1/4" Male elbow     | 2    |
| 016966 | 3/8 x 3/8" Male elbow     | 3    |
| 016986 | 1/2 x 3/8" Male elbow     | 2    |
| 016988 | 1/2 x 1/2" Male elbow     | 2    |

# FITTINGS & HARDWARE

## TRUCK & TRAILER REPAIR KITS



| Part # | Description                                  |
|--------|----------------------------------------------|
| 690031 | In-Cab Air Line Repair Kit - Push Lock       |
| 690033 | Air Brake Line Repair Kit - Push Lock        |
| 690035 | Nylon Tubing Repair Kit - Push Lock          |
| 690037 | Transmission Air Line Repair Kit - Push Lock |
| 690050 | NTA Fitting Kit                              |

### In-Cab Air Line Repair Kit

- 24 total fittings

| Part # | Description               | Qty. |
|--------|---------------------------|------|
| 016112 | 1/8 x 1/8" Male connector | 2    |
| 016114 | 1/8 x 1/4" Male connector | 2    |
| 016142 | 1/4 x 1/8" Male connector | 2    |
| 016144 | 1/4 x 1/4" Male connector | 2    |
| 016162 | 3/8 x 1/8" Male connector | 1    |
| 016164 | 3/8 x 1/4" Male connector | 1    |
| 016242 | 1/4 x 1/8" Elbow          | 1    |
| 016244 | 1/4 x 1/4" Elbow          | 1    |
| 016264 | 3/8 x 1/4" Elbow          | 1    |
| 016610 | 1/8" Union                | 2    |
| 016630 | 3/16" Union               | 2    |
| 016640 | 1/4" Union                | 2    |
| 016660 | 3/8" Union                | 1    |
| 016910 | 1/8" Tee                  | 1    |
| 016930 | 3/16" Tee                 | 1    |
| 016940 | 1/4" Tee                  | 1    |
| 016960 | 3/8" Tee                  | 1    |

### Air Brake Line Repair Kit

- 24 total fittings

| Part # | Description               | Qty. |
|--------|---------------------------|------|
| 016166 | 3/8 x 3/8" Male connector | 2    |
| 016168 | 3/8 x 1/2" Male connector | 1    |
| 016184 | 1/2 x 1/4" Male connector | 1    |
| 016268 | 3/8 x 1/2" Male connector | 1    |
| 016284 | 1/2 x 1/4" Male connector | 1    |
| 016286 | 1/2 x 3/8" Male connector | 1    |
| 016186 | 1/2 x 3/8" Male connector | 2    |
| 016188 | 1/2 x 1/2" Male connector | 1    |
| 016660 | 3/8" Union                | 2    |
| 016680 | 1/2" Union                | 2    |
| 016266 | 3/8 x 3/8" Elbow          | 2    |
| 016288 | 1/2 x 1/2" Elbow          | 1    |
| 016960 | 3/8" Tee                  | 2    |
| 016980 | 1/2" Tee                  | 2    |

### Nylon Tubing Repair Kit

| Part # | Description              | Qty. |
|--------|--------------------------|------|
| 020132 | 1/8" Blue nylon tubing   | 2'   |
| 020065 | 5/32" Black nylon tubing | 2'   |
| 020066 | 3/16" Black nylon tubing | 2'   |
| 020164 | 1/4" Yellow nylon tubing | 2'   |
| 020156 | 3/8" Red nylon tubing    | 2'   |
| 020168 | 1/2" Yellow nylon tubing | 2'   |
| 016610 | 1/8" Union               | 2    |
| 016620 | 5/32" Union              | 2    |
| 016630 | 3/16" Union              | 2    |
| 016640 | 1/4" Union               | 2    |
| 016660 | 3/8" Union               | 2    |
| 016680 | 1/2" Union               | 2    |
| 090014 | 7" Nylon tie straps      | 12   |
| 090028 | Nylon tube cutter        | 1    |



Call the Velvac Sales Team: **800.783.8871** [sales@velvac.com](mailto:sales@velvac.com)

© VELVAC INC. • 2405 South Calhoun Road • New Berlin, WI 53151-2709 • Toll Free: 800.783.8871 • Fax: 262.786.4101

## FITTING ASSORTMENTS

### Large Air Brake Fitting Assortment

- Assortment includes the following part numbers and quantities plus rack 690090 (in RETAIL section)

| Part # | Total Fittings |
|--------|----------------|
| 690059 | 583            |

**NOTE**  
See previous pages for fitting photos and descriptions.

| Part # | Quantity |
|--------|----------|
| 010087 | 50       |
| 010089 | 50       |
| 010094 | 25       |
| 010096 | 25       |
| 010098 | 25       |
| 011001 | 25       |
| 011003 | 50       |
| 011005 | 25       |
| 011007 | 10       |
| 011009 | 10       |
| 011013 | 25       |
| 011023 | 15       |
| 011025 | 5        |
| 011027 | 3        |
| 011029 | 3        |
| 011033 | 10       |

| Part # | Quantity |
|--------|----------|
| 011041 | 15       |
| 011043 | 10       |
| 011045 | 3        |
| 011047 | 2        |
| 011057 | 5        |
| 011059 | 3        |
| 011073 | 5        |
| 012017 | 10       |
| 012021 | 10       |
| 012035 | 5        |
| 012037 | 20       |
| 012041 | 10       |
| 012043 | 5        |
| 012045 | 10       |
| 012047 | 10       |
| 012049 | 5        |

| Part # | Quantity |
|--------|----------|
| 012053 | 3        |
| 012055 | 3        |
| 012067 | 10       |
| 012071 | 10       |
| 012087 | 5        |
| 012091 | 20       |
| 012093 | 5        |
| 012095 | 5        |
| 012097 | 5        |
| 013001 | 10       |
| 013003 | 5        |
| 013011 | 3        |
| 013041 | 5        |
| 013057 | 5        |
| 013075 | 5        |
| 690090 | 1        |

### Push-Lock Fitting Assortment

- Assortment includes the following part numbers and quantities plus rack 690090 (in RETAIL section)

| Part # | Total Fittings |
|--------|----------------|
| 690072 | 155            |



| Part # | Quantity |
|--------|----------|
| 016112 | 5        |
| 016114 | 5        |
| 016120 | 5        |
| 016122 | 5        |
| 016142 | 5        |
| 016144 | 5        |
| 016162 | 5        |
| 016164 | 5        |
| 016166 | 5        |
| 016168 | 5        |

| Part # | Quantity |
|--------|----------|
| 016184 | 5        |
| 016186 | 5        |
| 016188 | 5        |
| 016242 | 5        |
| 016244 | 5        |
| 016264 | 5        |
| 016266 | 5        |
| 016268 | 5        |
| 016284 | 5        |
| 016286 | 5        |
| 016288 | 5        |

| Part # | Quantity |
|--------|----------|
| 016610 | 5        |
| 016620 | 5        |
| 016630 | 5        |
| 016640 | 5        |
| 016660 | 5        |
| 016680 | 5        |
| 016930 | 5        |
| 016940 | 5        |
| 016960 | 5        |
| 016980 | 5        |
| 690090 | 1        |

# FITTINGS & HARDWARE

## FITTING ASSORTMENTS

### Nylon Air Brake Tube Fitting Assortment

- Assortment includes the following part numbers and quantities plus rack 690090 (in RETAIL section)

| Part # | Total Fittings |
|--------|----------------|
| 690071 | 304            |



| Part # | Quantity |
|--------|----------|
| 016100 | 3        |
| 016101 | 3        |
| 016140 | 25       |
| 016160 | 10       |
| 016180 | 5        |
| 016200 | 3        |
| 016201 | 2        |
| 016240 | 10       |
| 016260 | 5        |
| 016280 | 5        |
| 016300 | 10       |
| 016301 | 10       |
| 016340 | 25       |
| 016360 | 25       |

| Part # | Quantity |
|--------|----------|
| 016380 | 25       |
| 016808 | 3        |
| 016818 | 2        |
| 016842 | 10       |
| 016844 | 10       |
| 016862 | 5        |
| 016864 | 5        |
| 016866 | 5        |
| 016884 | 5        |
| 016886 | 5        |
| 016888 | 5        |
| 016908 | 3        |
| 016916 | 5        |
| 016918 | 2        |

| Part # | Quantity |
|--------|----------|
| 016922 | 5        |
| 016942 | 10       |
| 016944 | 10       |
| 016962 | 5        |
| 016964 | 5        |
| 016966 | 5        |
| 016968 | 5        |
| 016984 | 5        |
| 016986 | 5        |
| 016988 | 5        |
| 017264 | 5        |
| 017266 | 5        |
| 017286 | 3        |
| 690090 | 1        |

### Brass Pipe Fitting Assortment

- Assortment includes the following part numbers and quantities plus rack 690090 (in RETAIL section)

| Part # | Total Fittings |
|--------|----------------|
| 690064 | 340            |



| Part # | Quantity |
|--------|----------|
| 016001 | 5        |
| 016002 | 5        |
| 016003 | 5        |
| 016004 | 5        |
| 016051 | 10       |
| 016052 | 20       |
| 016053 | 20       |
| 016054 | 5        |
| 016067 | 10       |
| 016068 | 10       |
| 016069 | 5        |
| 016070 | 5        |

| Part # | Quantity |
|--------|----------|
| 016079 | 10       |
| 016080 | 10       |
| 016081 | 30       |
| 016083 | 5        |
| 016084 | 5        |
| 016087 | 5        |
| 017015 | 5        |
| 017017 | 5        |
| 017019 | 5        |
| 017021 | 5        |
| 017023 | 5        |
| 017025 | 5        |
| 017027 | 5        |

| Part # | Quantity |
|--------|----------|
| 017029 | 5        |
| 017051 | 10       |
| 017053 | 20       |
| 017055 | 20       |
| 017057 | 5        |
| 018006 | 10       |
| 018007 | 10       |
| 018008 | 10       |
| 018009 | 10       |
| 018010 | 20       |
| 018011 | 10       |
| 018012 | 5        |
| 690090 | 1        |



Call the Velvac Sales Team: **800.783.8871** [sales@velvac.com](mailto:sales@velvac.com)

© VELVAC INC. • 2405 South Calhoun Road • New Berlin, WI 53151-2709 • Toll Free: 800.783.8871 • Fax: 262.786.4101

# FITTINGS & HARDWARE

## HOSE CLAMPS AND COOLANT VALVES

### Miniature/General Purpose Slotted/Liner/EuroSeal® Clamps

- All clamps feature 300 series stainless steel bands
- Miniature, general purpose and liner clamps include yellow dichromate slotted hex head screws. Euro-Seal® clamps feature 300 series stainless steel screws



Miniature clamps ideal for use on air and fuel lines



General purpose slotted clamps meet applicable SAE J1508 requirements

| Miniature Clamps | General Purpose Slotted Clamps | Liner Clamps | Euro-Seal® Clamps | SAE Size | Clamping Range (in.) |
|------------------|--------------------------------|--------------|-------------------|----------|----------------------|
| 022204           | -                              | -            | -                 | 4        | 7/32 – 5/8           |
| 022206           | 022306                         | 022106       | 022506            | 6        | 5/16 – 5/8           |
| -                | 022308                         | 022108       | 022508            | 8        | 1/2 – 55/64          |
| -                | 022310                         | 022110       | 022510            | 10       | 5/8 – 1-1/16         |
| -                | 022312                         | 022112       | 022512            | 12       | 3/4 – 1-1/4          |
| -                | 022316                         | 022116       | 022516            | 16       | 1 – 1-5/8            |
| -                | 022320                         | 022120       | 022520            | 20       | 1-11/64 – 1-3/4      |
| -                | 022324                         | 022124       | 022524            | 24       | 1-1/4 – 2            |
| -                | 022328                         | 022128       | 022528            | 28       | 1-5/8 – 2-3/8        |
| -                | 022332                         | 022132       | 022532            | 32       | 1-3/4 – 2-1/2        |
| -                | 022336                         | 022136       | 022536            | 36       | 2 – 2-3/4            |
| -                | 022340                         | 022140       | 022540            | 40       | 2-5/32 – 2-15/16     |
| -                | 022344                         | 022144       | 022544            | 44       | 2-3/8 – 3-1/8        |
| -                | 022348                         | 022148       | 022548            | 48       | 2-3/4 – 3-1/2        |
| -                | 022352                         | -            | -                 | 52       | 2-13/16 – 3-3/4      |
| -                | 022356                         | -            | 022556            | 56       | 3-1/8 – 4            |
| -                | 022360                         | -            | -                 | 60       | 3-1/2 – 4-3/8        |
| -                | 022364                         | -            | 022564            | 64       | 4 – 4-3/4            |
| -                | 022372*                        | -            | 022572            | 72       | 4-3/8 – 5-1/8        |
| -                | 022380*                        | -            | 022680            | 80       | 4-3/4 – 5-1/2        |
| -                | 022388*                        | -            | 022688            | 88       | 5-1/8 – 5-7/8        |
| -                | 022396*                        | -            | -                 | 96       | 5-9/16 – 6-1/2       |
| -                | 022404*                        | -            | 022574            | 104      | 6-1/4 – 7-5/64       |

\*These clamps may be made smaller than the clamping range shows in the table. Following are the smallest diameters for each of these clamps in the order shown on the chart: 1-7/8", 2-1/2", 3-1/8", 3-5/8", 4-1/8"



Euro-Seal® clamps with embossed threads and rounded band edge help eliminate hose abrasion and damage. Clamps meet or exceed international specifications for material, corrosion resistance, sizing and torque



Liner clamps designed with inner liner to protect silicone hose from extruding through band slots; unique construction allows more tightening torque to the perforations while maximizing vibration resistance

Euro-Seal® is a registered trademark of Breeze Industrial Products

# FITTINGS & HARDWARE

## HOSE CLAMPS AND COOLANT VALVES

### Spring Loaded T-Bolt Clamps

- Eliminates "cold flow hose leaks" by automatically adjusting diameter for hose compression set or expansion/contraction of hose and fittings due to temperature changes
- Recommended for bus, truck and heavy-duty equipment air intake and coolant connectors
- 300 series stainless steel band, floating bridge liner and trunion
- Yellow dichromate plated steel bolt, spring, washer and 1/2" lock-nut
- Clamps meet applicable SAE J1508 requirements

| Part #  | Clamping Range (mm) | Clamping Range (in.) |
|---------|---------------------|----------------------|
| 022580  | 57 - 65             | 2-1/4 - 2-9/16       |
| 022581  | 67 - 77             | 2-3/4 - 3-1/16       |
| 022582* | 78 - 86             | 3-1/16 - 3-3/8       |
| 022583  | 87 - 95             | 3-7/16 - 3-3/4       |
| 022584* | 90 - 98             | 3-9/16 - 3-7/8       |
| 022585  | 98 - 106            | 3-7/8 - 4-3/16       |
| 022626* | 103 - 111           | 4-1/16 - 4-3/8       |
| 022586  | 106 - 114           | 4-3/16 - 4-1/2       |
| 022627* | 116 - 124           | 4-9/16 - 4-7/8       |

\* Designed for change-air cooling



### T-Bolt Clamps

- Applications include engine air intake, exhaust, hoses, filters and low pressure hydraulic connections
- 300 series stainless steel band, floating bridge liner and trunion
- Yellow dichromate plated steel bolt and 7/16" locknut
- Clamps meet applicable SAE J1508 requirements

| Part # | Clamping Range (mm) | Clamping Range (in.) |
|--------|---------------------|----------------------|
| 022550 | 63 - 71             | 2-1/2 - 2-13/16      |
| 022551 | 67 - 77             | 2-3/4 - 3-1/16       |
| 022587 | 76 - 84             | 3 - 3-5/16           |
| 022588 | 83 - 90             | 3-1/4 - 3-9/16       |
| 022589 | 87 - 98             | 3-7/16 - 3-7/8       |
| 022591 | 95 - 103            | 3-3/4 - 4-1/16       |
| 022592 | 108 - 116           | 4-1/4 - 4-9/16       |
| 022593 | 121 - 128           | 4-3/4 - 5-1/16       |
| 022557 | 133 - 141           | 5-1/4 - 5-9/16       |
| 022594 | 146 - 154           | 5-3/4 - 6-1/16       |
| 022596 | 159 - 166           | 6-1/4 - 6-9/16       |
| 022597 | 184 - 192           | 7-1/4 - 7-9/16       |
| 022598 | 216 - 223           | 8-1/2 - 8-13/16      |



Call the Velvac Sales Team: **800.783.8871** [sales@velvac.com](mailto:sales@velvac.com)

© VELVAC INC. • 2405 South Calhoun Road • New Berlin, WI 53151-2709 • Toll Free: 800.783.8871 • Fax: 262.786.4101

## HOSE CLAMPS AND COOLANT VALVES

### Constant-Torque® Clamps

- Patented Belleville spring design eliminates "cold flow hose leaks" by automatically adjusting diameter for hose compression set or expansion/contraction of hose and fittings due to temperature changes
- Specified by many top fleets for new vehicle installations
- Recommended for bus, truck and heavy-duty equipment air intake and coolant connections
- Extended inner liner covers worm gear slots to protect against extrusions and damage
- All stainless steel construction
- Extended adjustment range permits fewer stocked parts

**NOTE:** For proper installation, the Belleville spring washer stacks should be nearly collapsed flat and the screw tip should extend beyond 1/4". Using a torque wrench, tighten to recommended torque range

| Part #                         | Clamping Range (mm) | Clamping Range (in.) |
|--------------------------------|---------------------|----------------------|
| Torque rated at 30-70 in./lb.  |                     |                      |
| 022410                         | 14 – 27             | 9/16 – 1-1/16        |
| 022412                         | 17 – 32             | 11/16 – 1-1/4        |
| 022416                         | 21 – 38             | 13/16 – 1-1/2        |
| 022420                         | 21 – 44             | 13/16 – 1-3/4        |
| 022424                         | 27 – 51             | 1-1/16 – 2           |
| Torque rated at 40-125 in./lb. |                     |                      |
| 022400                         | 32 – 54             | 1-1/4 – 2-1/8        |
| 022425                         | 45 – 67             | 1-3/4 – 2-5/8        |
| 022430                         | 57 – 79             | 2-1/4 – 3-1/8        |
| 022435                         | 70 – 92             | 2-3/4 – 3-5/8        |
| 022440                         | 83 – 105            | 3-1/4 – 4-1/8        |
| 022445                         | 95 – 118            | 3-3/4 – 4-5/8        |
| 022450                         | 108 – 130           | 4-1/4 – 5-1/8        |

### Hi-Torque® Clamps

- Heavy gauge housing engineered so eight screw threads are simultaneously engaged to provide over four times the recommended SAE torque requirements of standard worm drive clamps
- All stainless steel construction
- Extended diameter ranges allow coverage from 1-1/4" to 9-1/8" with only four clamps
- Clamps exceed applicable SAE J1508 requirements

| Part # | Clamping Range (mm) | Clamping Range (in.) |
|--------|---------------------|----------------------|
| 022462 | 32 – 67             | 1-1/4 – 2-5/8        |
| 022463 | 54 – 105            | 2-1/8 – 4-1/8        |
| 022464 | 102 – 156           | 4 – 6-1/8            |
| 022465 | 156 – 232           | 6-1/8 – 9-1/8        |



Constant-Torque® clamp



Hi-Torque® clamp

Constant-Torque® and Hi-Torque® are registered trademarks of Breeze Industrial Products

# FITTINGS & HARDWARE

## HOSE CLAMPS AND COOLANT VALVES

### Muffler Clamps/Saddle Clamps

- Heavy duty clamp with round 3/8-16
- Zinc plated for corrosion protection
- Complete with grade 2 serrated flange nuts
- Individually packaged

| Part # | Size  |
|--------|-------|
| 022048 | 1.75" |
| 022049 | 2"    |
| 022050 | 2.5"  |
| 022051 | 3"    |
| 022052 | 3.5"  |
| 022053 | 4"    |
| 022054 | 4.5"  |
| 022055 | 5"    |



Muffler/saddler clamp

### Flat Band Clamp

- Manufactured with a stainless steel band for corrosion protection
- Clamp assembly consists of a stainless steel band with one spacer, two bolts and one reaction block pre-attached to band with one spacer and two nuts packaged with the band

| Part # | Size |
|--------|------|
| 022059 | 4"   |
| 022060 | 5"   |



Flat band clamp

### Guillotine Style Clamp

- Heavy-duty guillotine clamps are manufactured with a round 3/8 - 16 u-bolt and are zinc plated for corrosion protection
- Clamp contains a reinforced rib design for enhanced strength
- Packaged individually in a poly bag
- Complete with grade 2 serrated flange nuts

| Part # | Size |
|--------|------|
| 022056 | 4"   |
| 022057 | 4.5" |
| 022058 | 5"   |



Guillotine style clamp



Call the Velvac Sales Team: **800.783.8871** [sales@velvac.com](mailto:sales@velvac.com)

© VELVAC INC. • 2405 South Calhoun Road • New Berlin, WI 53151-2709 • Toll Free: 800.783.8871 • Fax: 262.786.4101



## HOSE CLAMPS AND COOLANT VALVES

### Turbo V-Band Clamp

| Part # | Nominal (in.) | Clamp Dimensions (in.) |      |      |      |      | Application                                                    |
|--------|---------------|------------------------|------|------|------|------|----------------------------------------------------------------|
|        |               | A                      | B    | C    | D    | E    |                                                                |
| 022470 | 3.82          | .077                   | .207 | .281 | .040 | .875 | CAT, DDC, Ford, GMC, Navistar                                  |
| 022471 | 3.88          | .050                   | .400 | .281 | .040 | .875 | Cummins, Ford, Volvo                                           |
| 022472 | 4.50          | .077                   | .207 | .281 | .040 | .875 | DDC, GMC, Navistar                                             |
| 022473 | 4.61          | .050                   | .156 | .218 | .035 | .750 | Mack, Switzer                                                  |
| 022474 | 4.75          | .077                   | .158 | .310 | .040 | .875 | Cummins, CAT, Freightliner, GMC, Navistar, Volvo, Western Star |
| 022475 | 5.25          | .050                   | .262 | .141 | .035 | .750 | DDC, Navistar, Freightliner                                    |
| 022476 | 5.88          | .050                   | .400 | .281 | .040 | .875 | Cummins, DDC, CAT                                              |
| 022477 | 4.50          | .050                   | .262 | .141 | .035 | .750 | Navistar                                                       |
| 022478 | 3.21          | .050                   | .262 | .141 | .035 | .750 | Cummins, Freightliner, Blue Bird bus, Ford, Oshkosh            |

- Clamps connect vehicle exhaust pipe flange to turbo or engine manifold
- Built to withstand high temperatures produced by heavy-duty engines and turbos
- All stainless steel construction
- Clamps meet or exceed OEM standards for material and quality

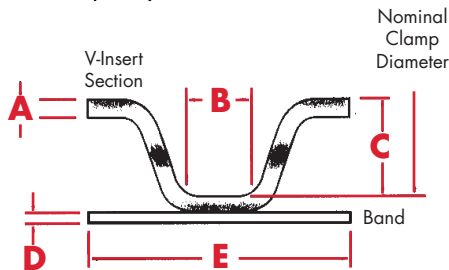

**AIR INTAKE SYSTEM**  
Hi-Torque or T-Bolt

**CHARGE AIR COOLING, AIR TO AIR AFTER-COOLING SYSTEM**  
Spring-Loaded T-Bolt

**TURBO EXHAUST MANIFOLD**  
V-Bolt

**FUEL LINE**  
Miniature

**COOLANT SYSTEM**  
Constant Torque or Hi-Torque

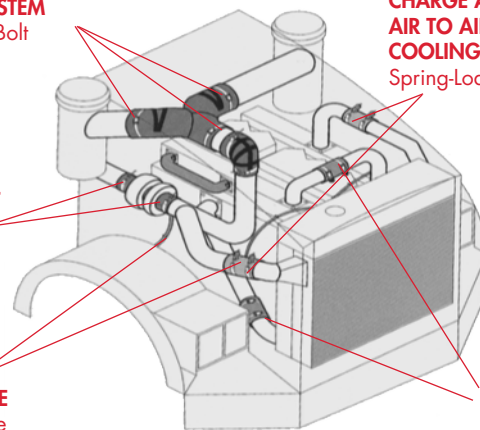

### Coolant Shutoff Valves

- All brass construction

| Part # | O.D. | Pipe Size |
|--------|------|-----------|
| 023066 | 3/8" | 3/8"      |
| 023106 | 5/8" | 3/8"      |
| 023108 | 5/8" | 1/2"      |
| 023126 | 3/4" | 3/8"      |
| 023128 | 3/4" | 1/2"      |



# FITTINGS & HARDWARE

## CLEVIS AND CLEVIS PINS

### Clevis

- Forged steel construction
- Zinc-plated for corrosion resistance

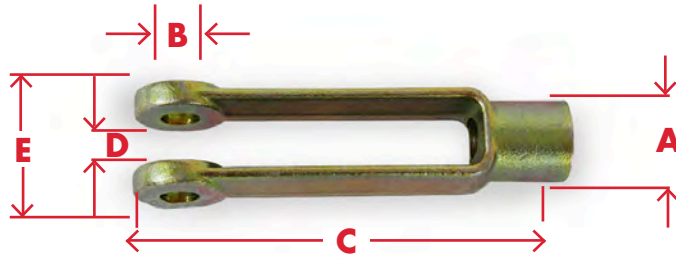

| Part # | A          | B     | C        | D      | E      |
|--------|------------|-------|----------|--------|--------|
| 019003 | 5/16" - 24 | 5/16" | 2-1/4"   | 11/32" | 3/4"   |
| 019004 | 3/8" - 24  | 3/8"  | 2-1/2"   | 7/16"  | 7/8"   |
| 019006 | 1/2" - 20  | 1/2"  | 3"       | 9/16"  | 1-1/8" |
| 019009 | 1/2" - 20  | 1/2"  | 1-7/8"   | 9/16"  | 1-1/4" |
| 019011 | 5/8" - 18  | 1/2"  | 1-7/8"   | 9/16"  | 1-1/4" |
| 019013 | 5/8" - 18  | 1/2"  | 2-5/16"  | 9/16"  | 1-1/2" |
| 019015 | 5/8" - 18  | 5/8"  | 4-15/16" | 11/16" | 1-3/8" |
| 019017 | 5/8" - 18  | 5/8"  | 2-5/16"  | 9/16"  | 1-1/2" |

### Clevis and Clevis Pin Kits

- Each kit includes one yoke, clevis pin and cotter pin
- Forged steel construction
- Zinc-plated for corrosion resistance

| Part #  | A         | B    | C        | D     | E      | F    | G      | H        |
|---------|-----------|------|----------|-------|--------|------|--------|----------|
| 019049  | 5/8" - 18 | 1/2" | 1-7/8"   | 9/16" | 1-1/4" | 1/2" | 1-1/2" | 1-3/8"   |
| 019050  | 1/2" - 20 | 1/2" | 1-7/8"   | 9/16" | 1-1/4" | 1/2" | 1-1/2" | 1-3/8"   |
| 019051  | 5/8" - 18 | 1/2" | 4-15/16" | 9/16" | 1-1/4" | 1/2" | 1-5/8" | 1-3/8"   |
| 019088* | 5/8" - 18 | 1/2" | 1-7/8"   | 9/16" | 1-1/4" | 1/2" | 1-1/2" | 1-11/32" |

\*Includes 3/8" x 1/4" reducer bushing and 5/8" - 18 hex nut

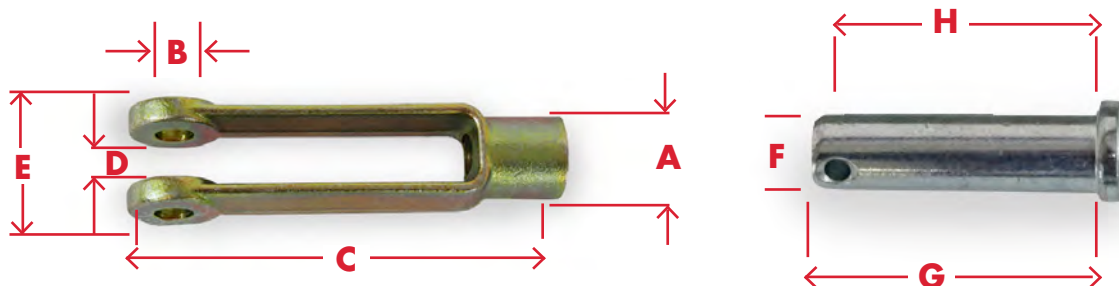

Call the Velvac Sales Team: **800.783.8871** [sales@velvac.com](mailto:sales@velvac.com)

### Standard Clevis Pin

| Part # | Nominal Size | A      | B      |
|--------|--------------|--------|--------|
| 019057 | 1/4          | 0.672" | 0.633" |
| 019059 | 5/16         | 0.812" | 0.757" |
| 019061 | 3/8          | 0.938" | 0.883" |
| 019065 | 1/2          | 1.203" | 1.133" |
| 019067 | 1/2          | 1.343" | 1.273" |
| 019069 | 1/2          | 1.593" | 1.523" |
| 019071 | 5/8          | 1.453" | 1.383" |
| 019073 | 5/8          | 1.593" | 1.523" |

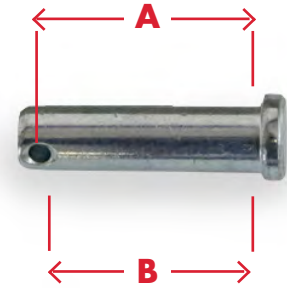

### Universal Clevis Pin

- Each includes cotter pin

| Part # | A     | B  | C      |
|--------|-------|----|--------|
| 019058 | 1/4"  | 2" | 17/32" |
| 019060 | 5/16" | 2" | 9/16"  |
| 019062 | 3/8"  | 2" | 17/32" |
| 019064 | 7/16" | 2" | 9/16"  |
| 019070 | 1/2"  | 2" | 9/16"  |
| 019072 | 5/8"  | 3" | 9/32"  |

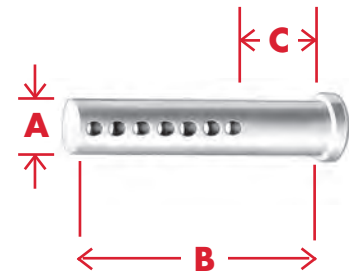

\*Holes are spaced at 1/4" intervals

## THE VELVAC DIFFERENCE

In the passing  
lane since 1934.



Velvac is TS 16949 &  
ISO 14001 certified.



For over 80 years **Velvac** has been providing high quality, innovative products with a focus on safety, value and great customer service. We stay out in front to help you stay ahead of your competition — that's what being in the passing lane is all about.



[velvac.com](http://velvac.com)



Call the Velvac Sales Team: **800.783.8871** [sales@velvac.com](mailto:sales@velvac.com)

© VELVAC INC. • 2405 South Calhoun Road • New Berlin, WI 53151-2709 • Toll Free: 800.783.8871 • Fax: 262.786.4101

**OUR PARTS PUT YOU IN THE PASSING LANE**

# FUEL SYSTEMS

## Protect your fuel system.

Velvac offers a wide range of locking fuel caps and anti-siphon tubes to keep unlawful occurrences at bay. With OEM approved designs and patented locking features, Velvac has your back.

- Fuel caps
- Anti-siphon tubes
- Tank valves



# FUEL SYSTEMS

## ALUMINUM NON-LOCKING FUEL CAPS — Designed for Diesel Fuel Applications

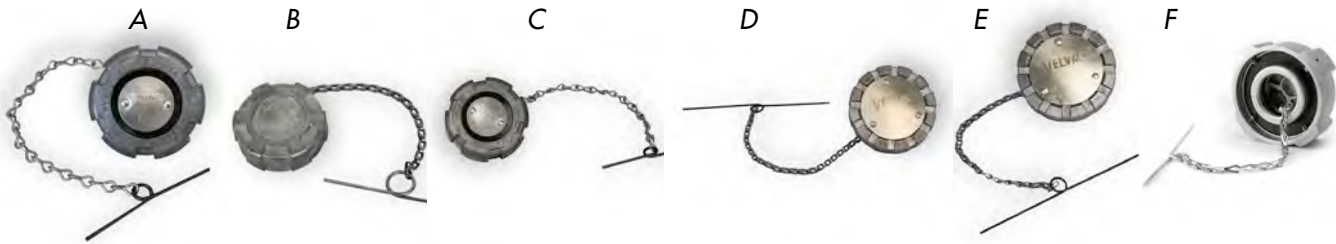

| Part # | Photo | Type                                                                        | V | T/R | P/R | Nominal Size | Threads Per Inch | Across Cap | Threads Filler Neck |
|--------|-------|-----------------------------------------------------------------------------|---|-----|-----|--------------|------------------|------------|---------------------|
| 600135 | A     | Female                                                                      | • | •   | •   | 2"           | 11-1/2 NPSH      | 2-1/4"     | 2-1/4"              |
| 600198 | B     | Female                                                                      | - | •   | -   | 2"           | 11-1/2 NPSH      | 2-1/4"     | 2-1/4"              |
| 600136 | C     | Female                                                                      | • | •   | •   | 2"           | 8 UN 2B          | 2-1/4"     | 2-1/4"              |
| 600186 | D     | Female<br>Replaces Freightliner A03-12927-4<br>and Kenworth K071-398**      | • | •   | •   | 3-1/2"       | 5-1/2            | 3-3/8"     | 3-1/2"              |
| 600184 | E     | Female<br>Replaces Freightliner A03-15682-4<br>and Western Star 43301-3401* | • | •   | •   | 3"           | 8 NPSL           | 3.37"      | 3.37"               |
| 600148 | F     | Female, 1/4 Turn<br>Replaces Freightliner 03-37017-000                      | - | •   | -   | 3"           | CAM CAP          | N/A        | N/A                 |
| 600168 | G     | Female                                                                      | - | •   | -   | 3"           | 8 NPSL           | 4.35"      | 4.35"               |
| 600180 | H     | Female                                                                      | • | •   | •   | 4"           | 8 NPSM           | 4.35"      | 4.35"               |
| 601065 | I     | Bayonet                                                                     | • | -   | -   | 4"           | N/A              | 3-7/8"     | 3-7/8"              |
| 600260 | J     | Female, Kenworth                                                            | • | •   | •   | 3"           | 5-1/2 NS         | 3.35"      | 3.35"               |
| 600264 | K     | Female, Reefer & International                                              | - | •   | -   | 2"           | 11-1/2 NPSH      | 2-1/4"     | 2-1/4"              |
| 600211 | L     | Lever, Peterbilt                                                            | - | -   | •   | 4"           | -                | N/A        | N/A                 |

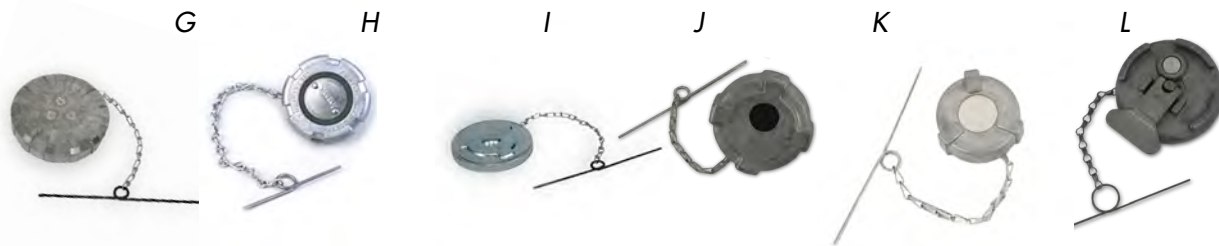

### Fuel Caps

- Comes in attractive clamshell packaging
- All locks have a single key available
- All locks are direct replacement of OEM caps

### NOTES

\* Freightliners after 1983 and Western Star after 1982 both with diesel fuel tanks with 3" male pipe filler necks

\*\* Freightliners prior to 1984 and Kenworth after 1984, Peterbilt prior to 1980 and Western Stars prior to 1983 all with diesel fuel tanks with 3" male pipe filler necks

**V** Vented

**T/R** Thermal relief

**P/R** Pressure relief



Call the Velvac Sales Team: **800.783.8871** sales@velvac.com

© VELVAC INC. • 2405 South Calhoun Road • New Berlin, WI 53151-2709 • Toll Free: 800.783.8871 • Fax: 262.786.4101

# FUEL SYSTEMS

## ALUMINUM LOCKING FUEL CAPS



| Part #      | Photo | Type                                                                     | V | T/R | P/R | Nominal Size | Threads Per Inch | Across Cap | Across Threads Filler Neck |
|-------------|-------|--------------------------------------------------------------------------|---|-----|-----|--------------|------------------|------------|----------------------------|
| 600150      | M     | Female, Freightliner M2                                                  | - | ●   | -   | 2.5"         | 8 UN             | 2.38"      | 2.38"                      |
| 600185-6*** | N     | Female<br>Replaces Freightliner A03-12927-6 and Kenworth K071-385-1234** | ● | ●   | ●   | 3"           | 5-1/2"           | 3-7/16"    | 3-1/2"                     |
| 600183-6*** | O     | Female<br>Replaces Freightliner A03-15682-6 and Western Star 43301-3403* | ● | ●   | ●   | 3"           | 8 NPSL           | 3.37"      | 3.37"                      |
| 600149      | P     | Female, 1/4 Turn<br>Replaces Freightliner 03-37017-002                   | - | ●   | -   | 3"           | CAM CAP          | N/A        | N/A                        |
| 600169-6    | Q     | Female                                                                   | - | ●   | ●   | 4"           | 8 NPSL           | 4.35"      | 4.35"                      |
| 600181-6    | R     | Female                                                                   | ● | ●   | ●   | 4"           | 8 NPSM           | 4.35"      | 4.35"                      |
| 600259      | S     | Female, Volvo, Mack & International                                      | - | -   | ●   | 3"           | 8 NPSL           | 3.37"      | 3.37"                      |
| 600263      | T     | Female, Kenworth w/ Thermo Relief                                        | - | ●   | -   | 3-1/2"       | 5-1/2 NS         | 3.38"      | 3.38"                      |
| 600212      | U     | Lever, Peterbilt                                                         | - | -   | ●   | 4"           | N/A              | N/A        | N/A                        |

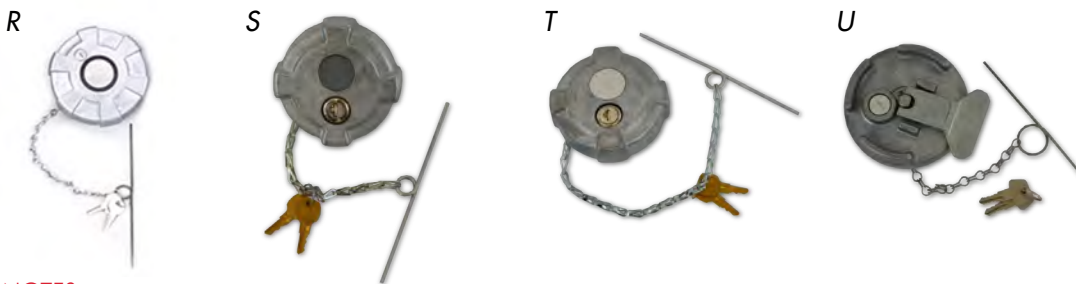

### NOTES

\*\*\* Keys not available separately

**V** Vented

**T/R** Thermal relief

**P/R** Pressure relief

### NOTE

All caps meet or exceed Federal Motor Carrier Safety Administration (FMCSA) requirements. This product conforms to the relief pressure and leakage rate test as required by 49 CFR 393.67 standards to protect from the inherent dangers associated with fuel leaks

Fuel caps come in attractive retail clamshell packaging

Part No. 600263 shown here >



# FUEL SYSTEMS

## GAS / DIESEL FUEL CAPS

Vented aluminum caps meet 49 CFR 393.67 requirements for vehicles built after October 1985. Vented brass caps are designed for use only on vehicles with non-vented fuel systems built prior to October 1985. Non-vented brass caps are designed for use only on vehicles equipped with properly vented fuel systems. For complete information on current fuel tank system requirements, see Code of Federal Regulations 49 CFR 393.67

- Available as vented or non-vented
- Fusible meltouts on brass fuel caps for thermal relief
- Safety chains and crossbars are standard on all caps except Part No. 600009 which features a 14" exterior cable with an attached 3/16" I.D. ring
- Patented Loc-Gard on locking cap protects against moisture and contaminants (US Patent No. 4,706,841)
- All locking fuel caps are supplied with 2 keys

### WARNING!

Aluminum fuel caps are designed ONLY for Diesel applications; brass fuel caps are designed for gasoline, diesel and oil applications



### Brass Locking Fuel Cap

- Nominal size - 2"
- Threads per inch - 11-1/2
- Cap - 2-1/4"
- Filler neck - 2-5/16"

| Part #   | Description        |
|----------|--------------------|
| 600196-6 | Female, non-vented |



### Aluminum Locking Fuel Cap

- Nominal size - 2"
- Threads per inch - 11-1/2
- Cap - 2-1/4"
- Filler neck - 2-5/16"

| Part # | Description        |
|--------|--------------------|
| 600270 | Female, non-vented |



### Brass Fuel Cap

- Nominal size - 2"
- Threads per inch - 11-1/2
- Cap - 2-1/4"
- Filler neck - 2-5/16"

| Part # | Description        |
|--------|--------------------|
| 600009 | Female, non-vented |



### Brass Fuel Cap

- Nominal size - 2"
- Threads per inch - 11-1/2
- Cap - 2-1/4"
- Filler neck - 2-5/16"

| Part # | Description        |
|--------|--------------------|
| 600133 | Female, non-vented |
| 600007 | Female, vented     |



### Brass Fuel Cap

- Nominal size - 2-1/8"
- Threads per inch - 12
- Cap - 2-1/8"
- Filler neck - 2-1/16"

| Part # | Description  |
|--------|--------------|
| 600017 | Male, vented |

**NOTE: Part numbers listed in RED are NEW!**



Call the Velvac Sales Team: **800.783.8871** sales@velvac.com

© VELVAC INC. • 2405 South Calhoun Road • New Berlin, WI 53151-2709 • Toll Free: 800.783.8871 • Fax: 262.786.4101



## REPLACEMENT PARTS FOR CAPS



| Part # | Replacement Part | Application                                |
|--------|------------------|--------------------------------------------|
| 600011 | 2" Gasket        | 600196-6, 600009, 600133, 600007           |
| 600021 | 2 1/8" Gasket    | 600017                                     |
| 600081 | 3" Gasket        | 600184, 600185-6, 600183-6                 |
| 601069 | 4" Gasket        | 600168, 600169-6, 600172, 600173-6         |
| 600041 | Lock Cam         | 600169-6                                   |
| 600053 | Lock Cam         | 600173-6                                   |
| 600175 | Loc-Gard cap     | 600173-6                                   |
| 600176 | Loc-Gard cap     | 600169-6, 600196-6                         |
| 601063 | Chain and bar    | 600168, 600169-6, 600172, 600173-6, 601065 |
| 600040 | Chain and bar    | 600007, 600017, 600133, 600196-6           |
| 600631 | Key No 31        | Lock No 31 - Used on 600169-6 and 600196-6 |
| 600632 | Key No 32        | Lock No 32 - Used on 600169-6 and 600196-6 |
| 600633 | Key No 33        | Lock No 33 - Used on 600169-6 and 600196-6 |
| 600219 | Key No 19        | Lock No 19 - Used on 600169-6 and 600196-6 |
| 600220 | Key No 20        | Lock No 20 - Used on 600169-6 and 600196-6 |
| 600221 | Key No 21        | Lock No 21 - Used on 600169-6 and 600196-6 |

## ANTI-SIPHON TUBES

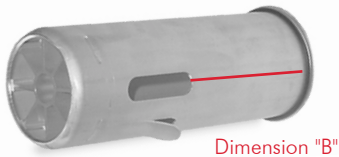

### Protect your fuel with Velvac's Anti-Siphon Tube

- Fast and easy installation — tube is designed to lock onto filler neck wall to prevent removal
- Eliminates the potential for fuel theft from syphoning through filler neck
- Durable all aluminum construction
- Vented design allows fueling at 20+ gallons per minute
- OEM approved with sizes to fit most vehicle applications



| Part # | Dimension "B" * | Description                                           |
|--------|-----------------|-------------------------------------------------------|
| 600241 | 3-3/4 inches    | Fits heavy duty Volvo, International and Mack trucks  |
| 600242 | 3-3/4 inches    | Fits heavy duty Volvo, International and Mack trucks  |
| 600243 | 2-3/4 inches    | Fits heavy duty Kenworth                              |
| 600244 | 2-3/4 inches    | Fits heavy duty Freightliner                          |
| 600245 | 2-1/4 inches    | Fits medium-duty trucks                               |
| 600246 | 3-3/4 inches    | Fits medium-duty and Reefer trucks                    |
| 600258 | -               | 4" Anti-siphon tube                                   |
| 600265 | -               | 2-1/2" Peterbilt anti-siphon tube w/ installation kit |

#### NOTE

\* Dimension "B" is from the underside of the top lip to the tip of the last barb

## FUEL TANK VALVES



### Ball Valve

- Designed for fuel line shutoff in gasoline and diesel vehicles. May also be used for water and air service lines
- Heavy-duty forged brass body provides extended service
- Teflon® seats and seals provide positive sealing with easy opening and closing
- 600 psi water, oil or fuel
- 150 psi on/off saturated steam service lines
- 29 in. Hg vacuum service

| Part # | Description |
|--------|-------------|
| 060050 | 1/2" NPT    |
| 060051 | 3/8" NPT    |
| 060053 | 1/4" NPT    |



Three-way  
060004



Three-way  
060012

### Tank Cocks

- All brass bodies
- Mounting flanges with 1/4" bolt holes
- Standard 1-1/2" stems



Four-way  
060001, 060007

| Part # | Description                                             |
|--------|---------------------------------------------------------|
| 060004 | Three-way tank cock with 3/8" FPT side ports            |
| 060012 | Three-way tank cock with 1/4" FPT bottom and side ports |
| 060001 | Four-way tank cock with 3/8" FPT bottom and side ports  |
| 060007 | Four-way tank cock with 1/4" FPT bottom and side ports  |

## RETURN FLOW SPLITTERS

- Designed for dual draw/dual return diesel fuel system
- Distributes fuel equally to both left and right tanks eliminating the need for crossover lines
- Durable zinc die cast bodies
- Convenient tee configuration for easy plumbing to each tank
- Applicable for marine use
- (3) 1/2" FPT ports
- (2) 1/4" mounting holes



| Part # | Description   | Vehicle Applications                                 |
|--------|---------------|------------------------------------------------------|
| 060070 | Standard flow | Fits heavy duty Volvo, International and Mack trucks |
| 060071 | High flow     | Fits heavy duty Volvo, International and Mack trucks |

## DIESEL FUEL VALVES



- All brass bodies provide added durability — both with 1/2" MPT bottom ports
- Neoprene seats make valves compatible with most liquids

| Part # | Description                                           |
|--------|-------------------------------------------------------|
| 060026 | Leveling valve with 1/2" FPT side port                |
| 060027 | Leveling valve with 5/8" SAE 45° male flare side port |



Call the Velvac Sales Team: **800.783.8871** sales@velvac.com

## ELECTRIC FUEL TANK SELECTOR VALVES

### Six Port Motor-Driven Valve

- Designed for systems with fuel or vapor return lines - not for use with fuel systems operating over 30 psi
- Reduces the possibility of fuel returning to incorrect tank as valve remains in actuated position after power is disconnected
- Permits high closing pressures
- Can be used for biodiesel, vegetable oil and olive oil
- 12 VDC
- Operating temperature range of -40° to 180° F
- 3/8" supply lines, 5/16" return lines
- Weatherproof electrical connector Part No. 060049 is required for all new installations



| Part # | Description                 |
|--------|-----------------------------|
| 060047 | Six port motor-driven valve |
| 060049 | Electrical connector        |

### Fuel Solenoid Shut Off Valve

- 12 VDC
- 3/8" port
- 3" overall height
- Includes seal ring and port plug



| Part # | Description         |
|--------|---------------------|
| 034095 | Fuel solenoid valve |

## FUEL TANK SAFETY VENTS

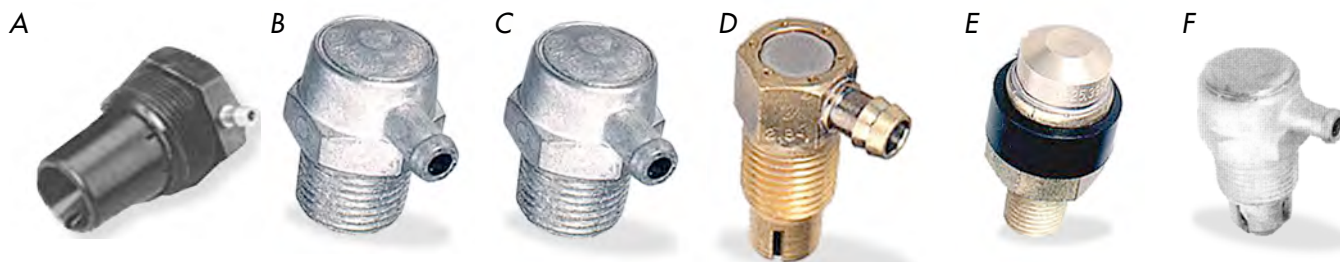

- Feature patented anti-spill protection
- Vents meet all applicable DOT requirements

| Part # | Photo | Thread Size           | Barb Size (I.D. Hose) | Fuel Application | Vehicle Application |
|--------|-------|-----------------------|-----------------------|------------------|---------------------|
| 060060 | A     | 1-1/4" PTF SAE Short  | 1/4"                  | Diesel           | Peterbilt           |
| 060061 | B     | 1/2"-14 PTF SAE Short | 5/16"                 | Gasoline         | Various             |
| 060062 | C     | 1/2"-14 PTF SAE Short | 5/16"                 | Diesel           | Various             |
| 060063 | D     | 1/4"-18" PTF          | 1/4"                  | Diesel           | Various             |

### Valves with Pressure and Thermal Relief Features

| Part # | Photo | Thread Size           | Barb Size (I.D. Hose) | Fuel Application | Pre-1992 |
|--------|-------|-----------------------|-----------------------|------------------|----------|
| 060040 | E     | 1/4"-18 PTF           | N/A                   | Diesel           | Kenworth |
| 060064 | F     | 1/2"-14 PTF SAE Short | 5/16"                 | Diesel           | Kenworth |

**NOTE: Part numbers listed in RED are NEW!**

## FUEL TANK VALVES

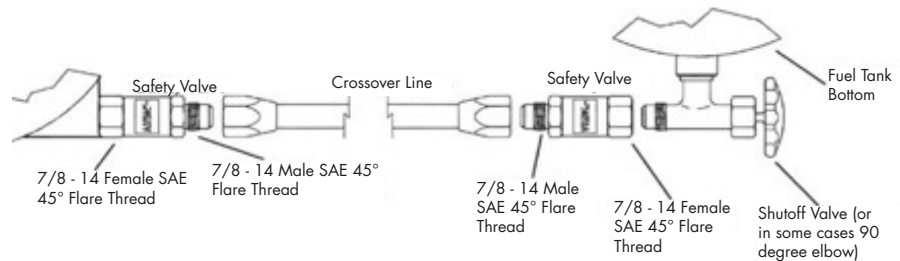

Fuel tank diagram

### Crossover Fuel Line Safety Valve

- Functions as a "fuse" in the fuel crossover line, automatically shutting off the flow of fuel if the line between a vehicle's main and auxiliary tanks is torn away or obstructed

- Separates before the crossover fuel line ruptures, preventing damage to fuel tank lines, fittings and valves

- Reduces the risk of fire and fuel slick by minimizing fuel loss if crossover fuel line is torn away
- 3-1/8" length, 1-1/4" diameter
- Lightweight aluminum construction

| Part # | Description                      |
|--------|----------------------------------|
| 060056 | Crossover fuel line safety valve |

## ADAPTER KITS



### Filler Neck Adapter Kit

- Part No. 600112 allows 2" female fuel caps to be installed on filler necks with small inside diameters
- Part No. 600191 allows 2" female fuel caps to be installed on 2-1/2" male filler neck with 8 threads per inch
- Include aluminum adapter, installation instructions and adhesive

| Part # | Description             |
|--------|-------------------------|
| 600112 | Filler neck adapter kit |
| 600191 | Filler neck adapter kit |

### Saddle Tank Mounting Kit

- Complete kit for mounting one saddle tank

| Part #               | Description              |     |
|----------------------|--------------------------|-----|
| 602002               | Saddle tank mounting kit |     |
| <b>Kit Contents:</b> |                          |     |
| Part #               | Description              | Qty |
| 060033               | Rubber pad               | 4   |
|                      | Spring                   | 4   |
|                      | Lock nut                 | 4   |
|                      | Hex bolt                 | 4   |

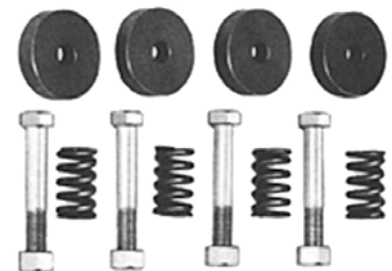

1/2" center hole

#### NOTE

Replacement rubber pads available; no replacements available for other kit parts.



Call the Velvac Sales Team: **800.783.8871** sales@velvac.com

**OUR PARTS PUT YOU IN THE PASSING LANE**

# **BACK-UP ALARMS**

## **Alarms, warning devices & switches.**

Velvac back-up alarms meet the needs of almost every vehicle application and environment.

- **Heavy duty OEM style**
- **Patented double-reflex horn**
- **Speaker alarms**



# BACK-UP ALARMS

## Horn Style Alarms

### Double Reflex Horn Style Back-up Alarm

10-Year Warranty

- Features patented double reflex horn speaker, providing efficient, high output sound with less power consumption and reduced heat for greater reliability and performance. 24" long folder horn allows alarm to run cooler by using about half the power consumption of conventional speaker alarms to achieve the same decibel output
- High impact glass filled nylon housing meets high temperature demands of SAE J994 and UL flame testing. Provides durability needed for the toughest work and vehicle environments
- 12-24 VDC polarity and peak voltage protection, temperature range -40° to +85°C



HD STD

- Slotted mounting centers with optional back or bottom mounting for easy installation
- Meets requirements of SAE J994, CE, eMark and UL, OSHA, MSHA, IP67
- 10 year warranty

### External Switch

- Switch will cause alarm to activate when linkage is shifted into reverse
- Operating temperatures of -40°F to +140°F
- 12-24 VDC
- Not for underwater use



| Part # | Description     |
|--------|-----------------|
| 697011 | External switch |

### Heavy Duty External Switch

- For use on vehicles that do not have back-up lights readily available
- Equiv: Preco SW30



| Part # | Voltage | Amps |
|--------|---------|------|
| 697012 | 12-80 V | 10   |

| Part #        | Decibels | Rated Current<br>mAmps (mA) | Connection<br>Type | Mounting<br>Bracket | Mounting<br>Center | ECCO<br>Equivalent | PRECO<br>Equivalent |
|---------------|----------|-----------------------------|--------------------|---------------------|--------------------|--------------------|---------------------|
| <b>HD STD</b> |          |                             |                    |                     |                    |                    |                     |
| 697002        | 107      | 300                         | Wire               | Integrated nylon    | 3.25"              | 575                | 270                 |



Call the Velvac Sales Team: **800.783.8871** sales@velvac.com

© VELVAC INC. • 2405 South Calhoun Road • New Berlin, WI 53151-2709 • Toll Free: 800.783.8871 • Fax: 262.786.4101

# BACK-UP ALARMS

## Speaker Style Alarms

- High impact glass filled nylon housing meets high temperature demands of SAE J994 and UL requirements for flame testing
- 12-24 VDC polarity and peak voltage protection
- Temperature range -40° to +85°C
- Epoxy encapsulation protection and 3 year warranty



697103



699287 & 699297

| Part # | Decibels | Rated Current<br>mAmps (mA) | Connection<br>Type | ECCO<br>Equivalent | PRECO<br>Equivalent |
|--------|----------|-----------------------------|--------------------|--------------------|---------------------|
| 697287 | 87       | 100                         | Wire               | —                  | —                   |
| 697297 | 97       | 500                         | Wire               | —                  | —                   |
| 699287 | 87       | 500                         | Terminal           | 505                | 220/240             |
| 699297 | 97       | 500                         | Terminal           | 510/520            | 230/240             |



697087, 697097 & 697107



697066 & 697112



699087, 699097 & 699107



699112

| Part # | Decibels | Rated Current<br>mAmps (mA) | Connection<br>Type | Mounting<br>Center | ECCO<br>Equivalent | PRECO<br>Equivalent |
|--------|----------|-----------------------------|--------------------|--------------------|--------------------|---------------------|
| 699087 | 87       | 200 - 300                   | Terminal           | 3.25               | 505                | 220/ELT 278         |
| 699097 | 97       | 200 - 300                   | Terminal           | 3.25               | 510/520            | 230/230LV/240       |
| 699107 | 107      | 200 - 300                   | Terminal           | 3.25               | —                  | 250                 |
| 699112 | 112      | 200 - 300                   | Terminal           | —                  | —                  | —                   |
| 697087 | 87       | 100 - 200                   | Wire               | 3.25               | —                  | —                   |
| 697097 | 97       | 100 - 200                   | Wire               | 3.25               | —                  | 240C5               |
| 697107 | 107      | 400 - 500                   | Wire               | 3.25               | 575                | 270                 |
| 697112 | 112      | 400 - 500                   | Wire               | 4.12               | —                  | —                   |
| 697066 | 87-112*  | 400 - 500                   | Wire               | 4.12               | SA901              | 1020                |

- High impact glass filled nylon housing meets high temperature demands of SAE J994 and provides durability needed for even tough work and vehicle environments
- Epoxy encapsulation protects electronics against moisture, allowing steam cleaning or pressure washing
- Ground strap included on 699 Series terminal alarms - two 9" x 16" gauge wires included
- Temperature range -40° to +85°C
- Slotted mounting centers with optional back or bottom mounting for easy installation - dimensions in table above
- Meets SAE J944 requirements
- 1 year warranty

# BACK-UP ALARMS

## BACK-UP ALARMS & WARNING DEVICES

### Flush Mount Alarms

- High impact glass filled nylon housing meets high temperature demands of SAE J994 and provides durability needed for even tough work and vehicle environments
- 12 - 24 VDC operation, temperature range -40° to +85°C
- 697124 and 697125 alarms are designed to mount flush into standard 4" hole on vehicle body. These alarms include rubber mounting boot and wire harness with mating connector
- 697187 and 697197 feature a compact design for mounting into 1/75" hole in vehicle body - overall unit depth is 1.28"



697187 & 697197

| Part # | Decibels | Rated Current mAmps (mA) | Connection Type           | Hole Diameter | ECCO Equivalent | PRECO Equivalent |
|--------|----------|--------------------------|---------------------------|---------------|-----------------|------------------|
| 697187 | 87       | 250                      | Wire                      | 1.75"         | —               | —                |
| 697197 | 97       | 250                      | Wire                      | 1.75"         | —               | —                |
| 697124 | 97       | 200 - 400                | Wire harness w/ connector | 4"            | 410/415         | 4030             |
| 697125 | 107      | 200 - 400                | Wire harness w/ connector | 4"            | 435             | 4050             |

### Warning Devices



696087, 696097 & 696107

| Part # | Decibels | Rated Current mAmps (mA) | Connection Type | Mounting Centers | ECCO Equivalent | PRECO Equivalent |
|--------|----------|--------------------------|-----------------|------------------|-----------------|------------------|
| 696087 | 87       | 90 - 400                 | Terminal        | 3.25"            | -               | -                |
| 696097 | 97       | 150 - 400                | Terminal        | 3.25"            | DT500           | D5232            |
| 696107 | 107      | 150 - 500                | Terminal        | 3.25"            | -               | -                |

- Yellow colored nylon housings clearly identify as warning devices
- 12 - 24 VDC operation - ground strap included
- Slotted mounting centers with optional back or bottom mounting for easy installation



Call the Velvac Sales Team: **800.783.8871** [sales@velvac.com](mailto:sales@velvac.com)



**OUR PARTS PUT YOU IN THE PASSING LANE**

# ACCESSORIES

**Yep, it's in here.**

From wiper blades to emergency triangles, if you couldn't find what you were looking for in the other sections of our catalog, it's probably right here.

- **Wiper blades & emergency triangles**
- **Tarp straps & king pin locks**
- **And a whole lot more!**



# ACCESSORIES

## WIPER BLADES



### Universal Winter Heavy Duty

- Heavy duty steel construction is surrounded by a rubber boot to minimize the accumulation of snow and ice on wiper blades

| Part # | Length | Anco # | Trico # |
|--------|--------|--------|---------|
| W15    | 15"    | 30-15  | 37-151  |
| W16    | 16"    | 30-16  | 37-160  |
| W18    | 18"    | 30-18  | 37-180  |
| W20    | 20"    | 30-20  | 37-205  |
| W22    | 22"    | 30-22  | 37-225  |
| W24    | 24"    | 30-24  | 37-245  |
| W28    | 28"    | -      | -       |



### Heavy Duty Flex Blades

- Designed for heavy duty arms that have less than 48 oz. of load. Can be used on flat or curved windshields with narrow saddle arms

| Part # | Length | Anco # | Trico #          |
|--------|--------|--------|------------------|
| 72-15  | 15"    | 52-15  | 63-151<br>64-150 |
| 72-16  | 16"    | 52-16  | 63-161<br>64-160 |
| 72-18  | 18"    | 52-18  | 63-18<br>64-180  |
| 72-20  | 20"    | 52-20  | 63-12<br>64-200  |



### Premium Universal Wiper Blade

- All makes premium heavy duty wiper blade replaces the Anco 91 Series heavy duty blade. Features a riveted all steel frame and compression molded rubber blade for increased life and durability

| Part # | Length | Anco # | Trico #                      |
|--------|--------|--------|------------------------------|
| 76-16  | 16"    | 91-16  | 16-1<br>16-2                 |
| 76-18  | 18"    | 91-18  | 18-1<br>18-2                 |
| 76-19  | 19"    | 91-19  | 19-1<br>19-2                 |
| 76-20  | 20"    | 91-20  | 20-1<br>20-2<br>20-4<br>20-9 |
| 76-21  | 21"    | 91-21  | 21-1                         |
| 76-22  | 22"    | 91-22  | 22-1<br>22-4<br>22-9         |
| 76-24  | 24"    | 91-24  | 24-1<br>24-4<br>24-9         |
| 76-28  | 28"    | 91-28  | 28-1                         |



### Winter Heavy Duty Narrow

- Heavy duty steel frame for narrow arms is surrounded by a rubber boot to minimize the accumulation of snow and ice

| Part # | Length | Anco # | Trico # |
|--------|--------|--------|---------|
| WN15   | 15"    | 59-15  | 66-150  |
| WN16   | 16"    | 59-16  | 66-160  |



Call the Velvac Sales Team: **800.783.8871** [sales@velvac.com](mailto:sales@velvac.com)

© VELVAC INC. • 2405 South Calhoun Road • New Berlin, WI 53151-2709 • Toll Free: 800.783.8871 • Fax: 262.786.4101

## WIPER BLADES



### Heavy Duty Flat Blade

- Used in flat windshield applications. Stainless steel rail. Typically used on heavy duty trucks, school buses, step vans and RVs

| Part # | Length | Anco # | Trico # |
|--------|--------|--------|---------|
| 71-13  | 13"    | 51-13  | 62-130  |
| 71-14  | 14"    | 51-14  | 61-140  |
| 71-15  | 15"    | 51-15  | 61-150  |
| 71-16  | 16"    | 51-16  | 61-160  |
| 71-18  | 18"    | 51-18  | 61-180  |



### Universal Wiper Blade

- All makes heavy duty wiper blade replaces the Anco 31 Series blade, featuring an all steel frame construction with compression molded-rubber for long life

| Part # | Length | Anco # | Trico # |
|--------|--------|--------|---------|
| 75-14  | 14"    | 31-14  | -       |
| 75-15  | 15"    | 31-15  | -       |
| 75-16  | 16"    | 31-16  | -       |
| 75-17  | 17"    | 31-17  | -       |
| 75-18  | 18"    | 31-18  | -       |
| 75-19  | 19"    | 31-19  | -       |
| 75-20  | 20"    | 31-20  | -       |
| 75-22  | 22"    | 31-22  | -       |
| 75-24  | 24"    | 31-24  | -       |

## TARP STRAPS

### Tarp Straps

- Made of molded rubber for ozone resistance and stretch resiliency
- Designed to hold tarp covers on trucks and trailers
- Hooks are crimped to prevent hook disconnection
- Straps will stretch up to twice their original length
- Premium and DPM straps add increased UV protection



| Rubber Tarp Part # | Premium EDPM | Description |
|--------------------|--------------|-------------|
| 580113             | 580118       | 9" Length   |
| 580114             | 580119       | 15" Length  |
| 580115             | 580120       | 21" Length  |
| 580116             | 580121       | 31" Length  |
| 580117             | 580122       | 41" Length  |

### WARNING!

Rubber tarp straps can have a strong spring tension and can cause bodily injury if they were to come unhooked or break. Safety glasses are recommended. Tarp straps are not to be used to restrain or secure cargo.

# ACCESSORIES

## EMERGENCY TRIANGLE

### Emergency Triangle Kit

- Kit contains three HD triangles packaged in a red plastic box
- Fluorescent orange plastic and red reflectors is visible day or night
- Snaps together for easy set up
- Heavy weighted sand filled base provides stability
- Meets all applicable FMVSS 125 and SAE/DOT specifications



| Part # | Description            |
|--------|------------------------|
| 090240 | Emergency triangle kit |

## KING PIN LOCK

### King Pin Lock

- Help deter unwanted trailer hookups
  - Made of durable cast iron, it enhances protection against theft, breakage or damage
  - Heavy duty zinc plated lock set helps deter rusting and extends service life
  - Lock set includes two (2) keys
- NOTE: Each King pin lock is randomly keyed  
NOTE: Keyed alike is not available



| Part # | Description   |
|--------|---------------|
| 019032 | King pin lock |

## MECHANICS WIRE

### Mechanics Wire

- Heavy-duty black annealed construction

| Part # | Wire Size | Roll Weight |
|--------|-----------|-------------|
| 090142 | 14 ga.    | 2 lb.       |
| 090145 | 14 ga.    | 5 lb.       |
| 090162 | 16 ga.    | 2 lb.       |
| 090165 | 16 ga.    | 5 lb.       |
| 090182 | 18 ga.    | 2 lb.       |
| 090185 | 18 ga.    | 5 lb.       |



Call the Velvac Sales Team: **800.783.8871** [sales@velvac.com](mailto:sales@velvac.com)

© VELVAC INC. • 2405 South Calhoun Road • New Berlin, WI 53151-2709 • Toll Free: 800.783.8871 • Fax: 262.786.4101

### Tite-Seal Document Storage Case

- Patented rubber caps create a watertight seal
- Aluminum mounting bracket features cushioned tube supports and pre-drilled mounting holes
- CapKeeper protective cable secures caps to mounting bracket

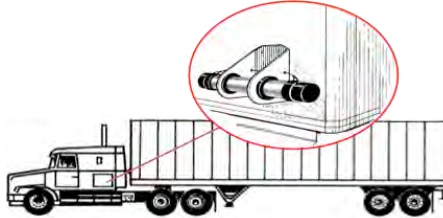

Case with bracket and CapKeeper™ cable



Light duty



Standard case with bracket

| Part #  | Description                                        |
|---------|----------------------------------------------------|
| 090113* | Light duty aluminum tube with painted steel cap    |
| 090114* | 9" Aluminum tube with bracket                      |
| 090115* | 9" Aluminum tube with bracket and CapKeeper cable  |
| 090116* | 12" Aluminum tube with bracket and CapKeeper cable |
| 090119  | Replacement rubber cap                             |

\* Bulk pack available. See price list

CapKeeper™ is a trademark of Velvac, Inc.

### License and Permit Holder

- UV-resistant Lexan®
- Inside dimensions are 3-1/8" to 3-3/4" wide x 5-1/2" high x 1-1/4" deep
- Three 1/4" mounting posts
- Documents secured by a metal spring clip and plate



| Part # | Description               |
|--------|---------------------------|
| 090060 | License and permit holder |
| 090061 | Replacement cover         |

Lexan® is a registered trademark of SABIC Innovation Plastics

# ACCESSORIES

## RADIATOR CAPS

### Heavy Duty Radiator Caps

- Velvac is now featuring all makes of heavy duty truck radiator caps



10208



10206



10238



10308



10205

| Part # | Deep Neck            | Pressure (lb.) |
|--------|----------------------|----------------|
| 10205  | 1"                   | 4              |
| 10206  | 1"                   | 7              |
| 10208  | 3/4"                 | 4              |
| 10238  | Threaded filler neck | 16             |
| 10308  | 3/4"                 | 4              |

- For radiator overflow reservoir systems



10227



10228, 10229



10230, 10231



10233



10237



10241, 10242

| Part # | I.D. Size | Deep Neck | Pressure (lb.) |
|--------|-----------|-----------|----------------|
| 10227  | 32 mm     | 16 mm     | 13             |
| 10228  | -         | 3/4"      | 7              |
| 10229  | -         | 3/4"      | 13             |
| 10230  | -         | 3/4"      | 16             |
| 10231  | -         | 3/4"      | 16 vented      |
| 10233  | 32 mm     | 16 mm     | 16             |
| 10237  | -         | 3/4"      | 10             |
| 10241  | 31 mm     | 10 mm     | 13             |
| 10242  | 31 mm     | 10 mm     | 16             |
| 10328  | -         | 3/4"      | 7              |
| 10329  | -         | 3/4"      | 13             |
| 10330  | -         | 3/4"      | 16             |
| 10331  | -         | 3/4"      | 16 vented      |
| 10333  | 32 mm     | 16 mm     | 16             |
| 10337  | -         | 3/4"      | 10             |



10330, 10331



10328, 10329



10333



10337

Manufactured by Stant®, an industry leader

Stant® is a registered trademark of Stant



Call the Velvac Sales Team: **800.783.8871** [sales@velvac.com](mailto:sales@velvac.com)

© VELVAC INC. • 2405 South Calhoun Road • New Berlin, WI 53151-2709 • Toll Free: 800.783.8871 • Fax: 262.786.4101

## RADIATOR CAPS

### Heavy Duty Radiator Caps (cont.)

| Part # | O.D. Size    | Deep Neck | Pressure (lb.) |
|--------|--------------|-----------|----------------|
| 10281  | "B" 2-11/16" | 3/4"      | 4              |
| 10282  | "B" 2-11/16" | 3/4"      | 7              |
| 10283  | "B" 2-11/16" | 3/4"      | 10             |
| 10292* | "B" 2-11/16" | 3/4"      | 7              |
| 10293* | "B" 2-11/16" | 3/4"      | 10             |
| 10294  | "B" 2-11/16" | 3/4"      | 15             |

Manufactured by Stant®, an industry leader



\*For radiator overflow reservoir systems

## CONSPICUITY TAPE

### Conspicuity Tape

- All the red and white conspicuity tape is DOT-C2 certified and guaranteed to meet or exceed all FMVSS 108 & NHTSA requirements
- The red and white tape comes with a 3, 5 or 10 year warranty
- School bus yellow tape has an enhanced daytime appearance and sight detection for safety. It meets or exceeds FMVSS 131 and FMVSS 217 requirements
- The white is a high performance polyester film that is thin and flexible
- The conspicuity strips are weather, solvent and UV resistant
- The red circles are SAE-A DOT approved
- The latest addition to the line is the diamond plate conspicuity tape. It is thin and flexible, weather resistant and has a distinctive design



058398



058370

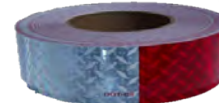

058402



058400



058373, 058374, 058377

| Part # | Description                                       | Warranty |
|--------|---------------------------------------------------|----------|
| 058395 | 2" x 150' Roll of 11" Red / 7" White              | 3 Year   |
| 058370 | 2" x 150' Roll of 11" Red / 7" White              | 5 Year   |
| 058396 | 2" x 150' Roll of 11" Red / 7" White              | 10 Year  |
| 058397 | 2" x 150' Roll of 6" Red / 6" White               | 5 Year   |
| 058402 | 2" x 150' Roll of 6" Red / 6" White diamond plate | 5 Year   |
| 058398 | 2" x 150' Roll of solid white                     | 5 Year   |
| 058400 | 1" x 150' Roll of solid yellow                    | 10 Year  |
| 058379 | 2" x 150' Roll of solid yellow                    | 10 Year  |

| Part # | Description                                    | Warranty |
|--------|------------------------------------------------|----------|
| 058373 | 2" x 18" 11" Red / 7" White conspicuity strips | 5 Year   |
| 058374 | 2" x 12" White conspicuity strips              | 5 Year   |
| 058377 | 2-3/4" Diameter red reflective circles         | N/A      |
| 058399 | 3-3/4" x 6-1/2" Reflective American flag       | 5 Year   |



058399

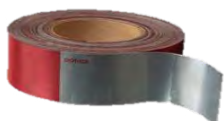

058395



058396

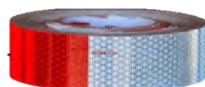

058397

**HDT TOP 20 AWARD WINNER**

**Hooking up  
your trailer just  
got really easy.**

**PATENT  
ISSUED**

U.S. PATENT NO.  
9,357,114 B1

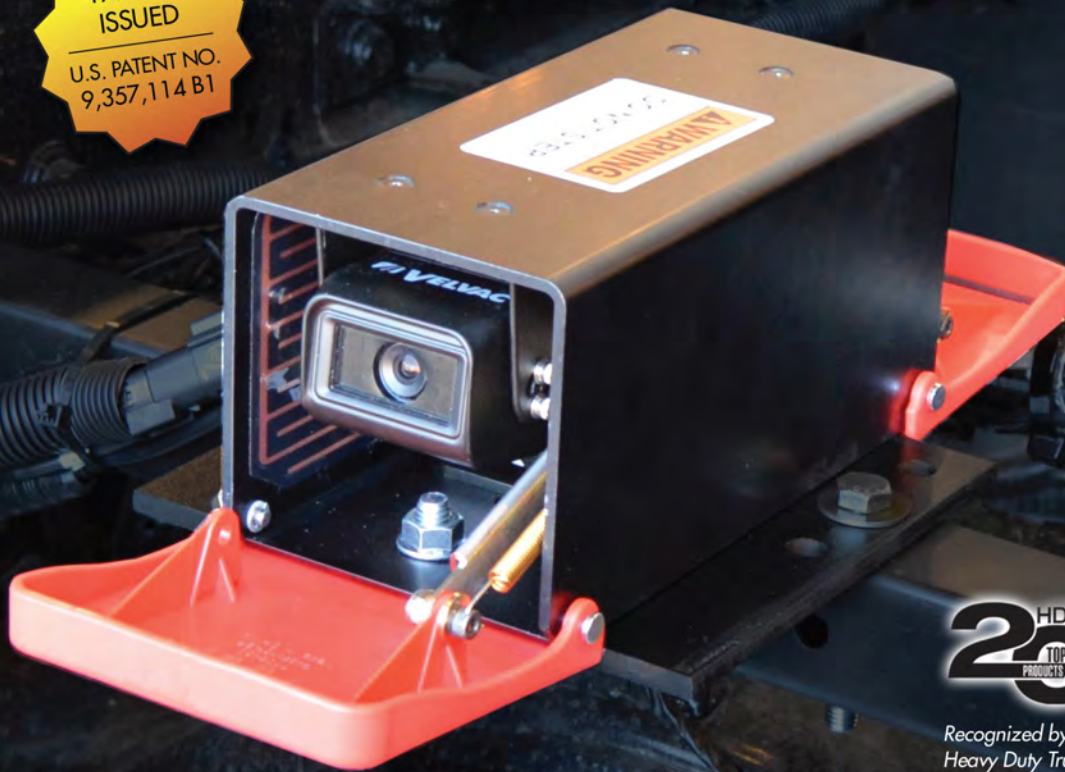

Recognized by  
Heavy Duty Trucking  
as a Top 20  
Product of the Year!

Our **5th Wheel Dual Camera System** makes it so much easier for commercial drivers to make sure that everything is lined up properly. Seeing the kingpin enter the throat of the 5th wheel helps ensure safety and takes the guesswork out of the coupling process. *Now patented!*

 **VELVAC**<sup>®</sup>  
*In the Passing Lane Since 1934*

velvac.com



See V11 for more info on the 5th Wheel Dual Camera System

Call the Velvac Sales Team: **800.783.8871** sales@velvac.com

© VELVAC INC. • 2405 South Calhoun Road • New Berlin, WI 53151-2709 • Toll Free: 800.783.8871 • Fax: 262.786.4101



**OUR PARTS PUT YOU IN THE PASSING LANE**

# RETAIL MERCHANDISING

## **Sell more with POP displays!**

Our attractive custom designed displays help your team organize and position the "high runners" that your customers are looking for.

- **Mirror, electrical & air displays**
- **Fittings & clamp displays**
- **Buckets, boxes & racks**



## DISPLAYS WITH PRODUCT ASSORTMENTS

### Mirror Assortment and Spinner Display



- Velvac now offers a 3-sided spinner display complete with an assortment of popular mirrors that reduce blind spots and improve driver safety.

- Part. No. 690110 includes:
  - » 17 popular mirrors
  - » 150 items total
  - » 3-sided spinner display
  - » Plan-o-gram
  - » 25 4" peg hooks

The assortment of mirrors includes:

- » West coast
- » 8½" convex
- » 5, 6, 7½" convex
- » Stick-on

**Assortment includes the following part numbers and quantities plus spinner display:**

| Part #      | Quantity |
|-------------|----------|
| 708501      | 12       |
| 708502      | 12       |
| 708556      | 6        |
| 708503      | 6        |
| 708520      | 10       |
| 708521      | 8        |
| 708515      | 10       |
| 708509      | 10       |
| 708508      | 10       |
| 705038      | 10       |
| 705333      | 8        |
| 705107      | 6        |
| 708331      | 6        |
| 705335      | 6        |
| 723050      | 10       |
| 723060      | 10       |
| 723065      | 10       |
| 723075      | 10       |
| 723100      | 3        |
| 690108      | 25       |
| 690104      | 1        |
| Plan-o-gram | 1        |

| Part # | Description                 |
|--------|-----------------------------|
| 690110 | Mirror assortment & display |



Call the Velvac Sales Team: **800.783.8871** [sales@velvac.com](mailto:sales@velvac.com)

## DISPLAYS WITH PRODUCT ASSORTMENTS

### Air and Electrical Display Rack



| Part # | Description                                                                                     |
|--------|-------------------------------------------------------------------------------------------------|
| 690201 | Includes rack and bins, air and electrical products, plan-o-gram, header, display and bin label |

- Ships with an attractive laminated Velvac header
- Designed for a flexible product set
- Bins are designed to accept dividers to increase storage possibilities
- Display is formed from 16-gauge steel for strength and stability
- Display is designed to hold up to 800 pounds
- Easy to assemble
- Ships with plan-o-gram

**Assortment includes the following part numbers and quantities plus air and electrical display pack:**

| Part # | Quantity |
|--------|----------|
| 035031 | 40       |
| 035032 | 40       |
| 035033 | 40       |
| 035037 | 5        |
| 035092 | 5        |
| 035093 | 5        |
| 035009 | 100      |
| 035010 | 100      |
| 035011 | 100      |
| 035094 | 5        |
| 035095 | 5        |
| 035007 | 50       |
| 035070 | 4        |
| 022002 | 5        |
| 022001 | 5        |
| 022025 | 5        |
| 032082 | 5        |
| 032058 | 5        |
| 590160 | 4        |
| 590161 | 4        |
| 590163 | 4        |
| 590155 | 4        |
| 590157 | 4        |
| 593057 | 5        |
| 593022 | 5        |
| 593083 | 5        |
| 593084 | 5        |
| 038001 | 5        |
| 038003 | 5        |
| 038005 | 5        |
| 580037 | 10       |
| 580039 | 5        |
| 580040 | 5        |

## DISPLAYS WITH PRODUCT ASSORTMENTS

### Electrical Component Assortment and Spinner Display



- Assortment of popular, high running electrical components
  - » Butt and ring tongue connectors
  - » Quick slide connectors
  - » Heatless connectors
  - » Fuse holders and fuses
  - » Heat shrink tubing
  - » Silicon self-sealing tape
  - » Electrical tape
  - » Crimping tools
  - » Cable ties
- Includes:
  - » 65 popular, high running part numbers
  - » 226 items total
  - » 3-sided spinner display
  - » Plan-o-gram
  - » 107 4" peg hooks

| Part # | Description                     |
|--------|---------------------------------|
| 690111 | Electrical assortment & display |

*Assortment includes the following part numbers and quantities plus spinner display:*

| Part #    | Quantity | Part #      | Quantity |
|-----------|----------|-------------|----------|
| 058313-10 | 10       | 090068-100  | 9        |
| 058313-40 | 10       | 091190      | 4        |
| 058314-10 | 6        | 091130      | 4        |
| 058314-40 | 4        | 091426      | 2        |
| 058312-10 | 4        | 091189      | 2        |
| 058312-50 | 6        | 091325      | 2        |
| 056052-10 | 4        | 091326      | 2        |
| 056052-50 | 6        | 091175-5    | 2        |
| 056053-10 | 4        | 091180-5    | 2        |
| 056053-50 | 6        | 091181-5    | 2        |
| 056051-50 | 6        | 091182-5    | 2        |
| 057086-50 | 4        | 091183-5    | 2        |
| 058026    | 2        | 091184-5    | 2        |
| 090070-25 | 9        | 091303-5    | 2        |
| 058303-50 | 4        | 091305-5    | 2        |
| 058304-50 | 4        | 091306-5    | 2        |
| 058306-50 | 2        | 091307-5    | 2        |
| 056005-10 | 4        | 091308-5    | 2        |
| 056005-50 | 4        | 091309-5    | 2        |
| 056006-50 | 4        | 091400-5    | 2        |
| 056008-50 | 4        | 091401-5    | 2        |
| 056011-50 | 2        | 091402-5    | 2        |
| 058316-40 | 2        | 091403-5    | 2        |
| 058319-50 | 2        | 091404-5    | 2        |
| 056070-50 | 2        | 091131-5    | 2        |
| 056067-50 | 2        | 091135-5    | 2        |
| 056111-5  | 3        | 091140-5    | 2        |
| 056112-5  | 3        | 091142-5    | 2        |
| 056113-5  | 3        | 091144-5    | 2        |
| 058382    | 8        | 091254      | 4        |
| 058380    | 2        | 090066-100  | 9        |
| 057131    | 2        | 690104      | 1        |
| 057132    | 2        | Plan-o-gram | 1        |
| 057133    | 2        |             |          |



Call the Velvac Sales Team: **800.783.8871** [sales@velvac.com](mailto:sales@velvac.com)

### Brass Fitting POP Display

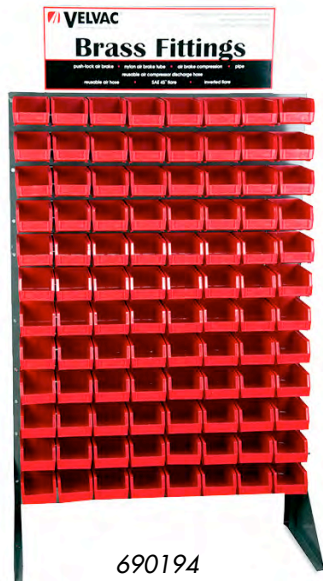

- Designed for more flexibility and storage space
- Attractive header card puts the Velvac name in front of customers
- Bins are designed to accept dividers that increase storage possibilities
- Frame is formed from 16-gauge steel for strength and stability
- Frame is designed to hold up to 800 pounds
- Choose from 3 different bin size layouts to best fit your needs
- Display assembly can be ordered in 3 different pre-designed configurations or by the individual pieces for a more custom display

### Fitting Labels

| Part # | Description                                 |
|--------|---------------------------------------------|
| 409904 | Complete set of bin labels for all fittings |

\* Packet of peelable sticker labels for use on all brass fittings POP display units

| Part # | Cabinet Configurations                                                                                                                                  |
|--------|---------------------------------------------------------------------------------------------------------------------------------------------------------|
| 690194 | Velvac header card, instruction sheet, 96 small bins and 48 small bin dividers                                                                          |
| 690195 | Velvac header card, instruction sheet, 56 small bins, 4 medium bins, 2 large bins, 28 small bin dividers, 2 medium bin dividers and 1 large bin divider |
| 690196 | Velvac header card, instruction sheet, 40 small bins, 8 medium bins, 2 large bins, 20 small bin dividers, 4 medium bin dividers and 1 large bin divider |



| Part # | Type               | Specs                                                                                                                                   |
|--------|--------------------|-----------------------------------------------------------------------------------------------------------------------------------------|
| 690187 | Cabinet frame only | 54"H x 36"W x 16"D<br>(Header adds 10")                                                                                                 |
| 690188 | Small storage bin  | 7 <sup>3</sup> / <sub>8</sub> "L x 4 <sup>1</sup> / <sub>8</sub> "W x 3"H<br>(Holds: 50 seals, 5-10 drain plugs or 4-5 gladhands)       |
| 690189 | Medium storage bin | 10 <sup>3</sup> / <sub>4</sub> "L x 8 <sup>1</sup> / <sub>4</sub> "W x 7"H<br>(Holds: 15 gladhands, 15 7-way plugs or 10 sockets)       |
| 690190 | Large storage bin  | 14 <sup>3</sup> / <sub>4</sub> "L x 16 <sup>1</sup> / <sub>2</sub> "W x 7"H<br>(Holds: 2-3 coiled electric sets or 1-2 coiled air sets) |
| 690191 | Small bin divider  | 2 <sup>1</sup> / <sub>2</sub> "H x 6 <sup>3</sup> / <sub>4</sub> "L                                                                     |
| 690192 | Medium bin divider | 6 <sup>1</sup> / <sub>2</sub> "H x 10"L                                                                                                 |
| 690193 | Large bin divider  | 6 <sup>1</sup> / <sub>2</sub> "H x 13 <sup>3</sup> / <sub>4</sub> "L                                                                    |



## FITTINGS DISPLAY RACKS

### Fitting Assortments



| Part # | Pipe Size                                      | Total Fittings |
|--------|------------------------------------------------|----------------|
| 690072 | Push-lock fitting assortment                   | 155            |
| 690059 | Large air brake compression fitting assortment | 583            |
| 690071 | Nylon air brake tube fitting assortment        | 304            |
| 690064 | Brass pipe fitting assortment                  | 340            |
| 690090 | Cabinet only                                   | -              |
| 690091 | Replacement drawer dividers (Pkg. qty 12)      | -              |

- Steel cabinet with rust-resistant baked enamel finish
- Cabinet includes 18 drawer dividers and 9 large steel drawers with a "positive stop" feature, preventing drawers from being accidentally pulled out
- Dimensions:  
17¼"W x 10⅞"H x 11⅝"D
- Assortments come complete with all specified fittings, cabinet and drawer dividers

## BUCKET AND COUNTER BOXES

### Counter Top Bucket Display



- A convenient way to display new products while increasing your inside store sales
- Round clear canister, 7" diameter x 7½" height
- Sold complete with cover for easy shipping or fleet sales
- Product label includes an area to display your part number, UPC code and price

| Part #   | Contents                                |
|----------|-----------------------------------------|
| 035160   | 200 Black polyurethane gladhand seals   |
| 035161   | 200 Red polyurethane gladhand seals     |
| 035162   | 200 Blue polyurethane gladhand seals    |
| 035163   | 200 Black rubber gladhand seals         |
| 058380-4 | 10 Rolls black silicon self fusing tape |
| 058381-4 | 10 Rolls red silicon self fusing tape   |
| 690202   | Display bucket only                     |



Call the Velvac Sales Team: **800.783.8871** [sales@velvac.com](mailto:sales@velvac.com)

## BUCKET AND COUNTER BOXES

### Polyurethane Gladhand Seals



- Color-coded seals will not crack or tear, reducing maintenance time and costs associated with rubber seal replacement
- Available in an attractive display box with 25 sets of seals (sets consist of 4 seals per bag, 2 red and 2 blue)

| Part # | Description              |
|--------|--------------------------|
| 035012 | Display box with seals   |
| 035009 | Red polyurethane seals   |
| 035010 | Blue polyurethane seals  |
| 035011 | Black polyurethane seals |

### Display Bin Box



- Manufactured with corrugated cardboard for extra durability
- Great for store merchandising or storage of loose parts
- Fits on standard shelving or display units
- Complete with Velvac logo for store merchandising and branding

| Part # | Description   |
|--------|---------------|
| 690007 | White 4" x 9" |
| 690008 | White 6" x 9" |

## HOSE CLAMP AND AIR HOSE RACKS

### Slotted Hose Clamp Rack and Assortment



- Assortment includes rack, header and 200 of the fastest moving miniature and general purpose slotted clamps

| Part # | Description                          |
|--------|--------------------------------------|
| 022632 | Slotted hose clamp rack & assortment |

**Assortment includes the following hose clamps:**

| Part # | SAE Size | Quantity | Description     | Range (in.)      |
|--------|----------|----------|-----------------|------------------|
| 022204 | 4 Mini   | 30       | Miniature clamp | 7/32" - 5/8"     |
| 022206 | 6 Mini   | 30       | Miniature clamp | 7/16" - 25/32"   |
| 022310 | 10       | 20       | Slotted clamp   | 9/16" - 1-1/16"  |
| 022312 | 12       | 20       | Slotted clamp   | 11/16" - 1-1/4"  |
| 022320 | 20       | 20       | Slotted clamp   | 13/16" - 1-3/4"  |
| 022324 | 24       | 20       | Slotted clamp   | 1-1/16" - 2"     |
| 022328 | 28       | 20       | Slotted clamp   | 1-5/16" - 2-1/4" |
| 022332 | 32       | 20       | Slotted clamp   | 1-9/16" - 2-1/2" |
| 022336 | 36       | 20       | Slotted clamp   | 1-13/16" - 2"    |
| 022565 | 1        | -        | Rack & header   | -                |

## HOSE CLAMP AND AIR HOSE RACKS

### Large Hose Clamp Rack



- Attractive freestanding or wall mountable display
- Includes 270 of the most popular clamp offerings
- Rack dimensions: 21 1/2"W x 23"H x 8"D
- Moveable hooks allow for several different configurations

| Part # | Description                                |
|--------|--------------------------------------------|
| 022628 | Rack and header only                       |
| 022630 | Hose clamp assortment with rack and header |

#### Assortment includes the following hose clamps:

| Part # | Description         | Size              | Quantity |
|--------|---------------------|-------------------|----------|
| 022204 | Mini clamp          | 7/32" x 5/8"      | 20       |
| 022206 | Mini clamp          | 7/16" x 25/32"    | 20       |
| 022310 | Slotted clamp       | 9/16" x 1 1/16"   | 20       |
| 022312 | Slotted clamp       | 1 1/16" - 1 1/4"  | 20       |
| 022320 | Slotted clamp       | 1 3/16" - 1 3/4"  | 20       |
| 022324 | Slotted clamp       | 1 1/16" - 2"      | 20       |
| 022328 | Slotted clamp       | 1 5/16" - 2 1/4"  | 20       |
| 022332 | Slotted clamp       | 1 9/16" - 2 1/2"  | 20       |
| 022336 | Slotted clamp       | 1 13/16" - 2 3/4" | 20       |
| 022626 | Spring T-bolt clamp | 4 1/16" - 4 3/8"  | 15       |
| 022581 | Spring T-bolt clamp | 2 3/4" - 3 1/16"  | 15       |
| 022430 | Constant torq clamp | 2 1/4" - 3 1/8"   | 15       |
| 022435 | Constant torq clamp | 2 3/4" - 3 5/8"   | 15       |
| 022425 | Constant torq clamp | 1 3/4" - 2 5/8"   | 15       |
| 022445 | Constant torq clamp | 3 3/4" - 4 5/8"   | 15       |

### Air Brake Hose Assembly Display Rack



- For display and organization of 3/8" and 1/2" air hose assemblies
- 12 separate slots hold up to 48 hose assemblies
- Rack measures 21"W x 6"H x 6"D
- Air brake hose assemblies sold separately

| Part # | Description  |
|--------|--------------|
| 691020 | Display rack |



Call the Velvac Sales Team: **800.783.8871** [sales@velvac.com](mailto:sales@velvac.com)



### Three-Sided Spinner Display



Product sold separately

- Increase your sales opportunities by displaying product and letting your customers know what you have available for sale
- Assembles in minutes - no tools required
- Stands 5' tall (5'6" with the 3 Velvac header signs)
- Three 16" pegboard panels
- Rotating display stand

| Part # | Description                  |
|--------|------------------------------|
| 690104 | 3-sided spinner display only |

#### Peghooks available separately:

| Part # | Description |
|--------|-------------|
| 690108 | 4" Peghooks |
| 690107 | 2" Peghooks |

### Wiper Blade Rack



Product sold separately

- Attractive 16-prong POP display

| Part # | Description              |
|--------|--------------------------|
| 690203 | Wiper blade display rack |

### Primary Wire Rack



- Holds (12) 100' spools, (8) 100' & (2) 1000' spools or (4) 1000' spools

| Part # | Description       |
|--------|-------------------|
| 691015 | Primary wire rack |

**NOTE: Part numbers listed in RED are NEW!**

## 100+ PAGES OF OE REPLACEMENT MIRROR PARTS



**Broken mirror?  
Today's your lucky day.**

With more than 100 pages of **OE Replacement Mirrors** in our catalog, finding your vehicle's mirror isn't the hard part, it's forgiving the "other guy" for breaking it in the first place. Whether it's just the glass, a part or the whole mirror assembly, we've got you covered — *and that's not luck, it's Velvac.*



[velvac.com](http://velvac.com)



OE Replacement Mirrors and Parts start on page M32

Call the Velvac Sales Team: **800.783.8871** [sales@velvac.com](mailto:sales@velvac.com)

© VELVAC INC. • 2405 South Calhoun Road • New Berlin, WI 53151-2709 • Toll Free: 800.783.8871 • Fax: 262.786.4101

**OUR PARTS PUT YOU IN THE PASSING LANE**

# INDEX

**Search every product.**

Find what you're looking for fast with our search index that doesn't require a magnifying glass to view.

- **Part Numbers**
- **Sectional Page Listings**
- **Visit [velvac.com](http://velvac.com) for more**



## PARTS INDEX

**MIRRORS M**

**VISION SYSTEMS V**

**HOSE SUPPORT H**

**AIR PRODUCTS A**

**ELECTRICAL PRODUCTS E**

**FITTINGS & HARDWARE FH**

**FUEL PRODUCTS F**

**BACK-UP CAMERAS B**

**ACCESSORIES AC**

**RETAIL MERCHANDISING R**

### THE VELVAC SECTIONAL CATALOG

To make finding the part you need easier, all products have been numbered sequentially and listed with their sectional page reference number. For the most up-to-date listing of products, please visit our online catalog at: [velvac.com](http://velvac.com)

| PART NO. | PAGE | PART NO. | PAGE | PART NO. | PAGE | PART NO. | PAGE |
|----------|------|----------|------|----------|------|----------|------|
| 71-13    | AC3  | 76-16    | AC2  | 011034   | FH11 | 014212   | FH14 |
| 71-14    | AC3  | 76-18    | AC2  | 011041   | FH8  | 014216   | FH14 |
| 71-15    | AC3  | 76-19    | AC2  | 011043   | FH8  | 014217   | FH14 |
| 71-16    | AC3  | 76-20    | AC2  | 011045   | FH8  | 014218   | FH14 |
| 71-18    | AC3  | 76-21    | AC2  | 011047   | FH8  | 014806   | FH14 |
| 72-15    | AC2  | 76-22    | AC2  | 011051   | FH8  | 014808   | FH14 |
| 72-16    | AC2  | 76-24    | AC2  | 011057   | FH8  | 014811   | FH14 |
| 72-18    | AC2  | 76-28    | AC2  | 011059   | FH8  | 014818   | FH14 |
| 72-20    | AC2  | 10205    | AC6  | 011073   | FH17 | 014822   | FH14 |
| 75-14    | AC3  | 10206    | AC6  | 011093   | FH8  | 014832   | FH14 |
| 75-15    | AC3  | 10208    | AC6  | 012012   | FH11 | 014842   | FH14 |
| 75-16    | AC3  | 10227    | AC6  | 012014   | FH11 | 014844   | FH14 |
| 75-17    | AC3  | 10228    | AC6  | 012015   | FH11 | 014852   | FH14 |
| 75-18    | AC3  | 10229    | AC6  | 012016   | FH11 | 014854   | FH14 |
| 75-19    | AC3  | 10230    | AC6  | 012017   | FH8  | 014862   | FH14 |
| 75-20    | AC3  | 10231    | AC6  | 012021   | FH8  | 014864   | FH14 |
| 75-22    | AC3  | 10233    | AC6  | 012022   | FH11 | 014866   | FH14 |
| 75-24    | AC3  | 10237    | AC6  | 012023   | FH8  | 014868   | FH14 |
|          |      | 10238    | AC6  | 012035   | FH8  | 014884   | FH14 |
|          |      |          |      | 012037   | FH8  | 014886   | FH14 |
|          |      |          |      | 012041   | FH8  | 014888   | FH14 |
|          |      |          |      | 012043   | FH8  | 014906   | FH14 |
|          |      |          |      | 012045   | FH8  | 014908   | FH14 |
|          |      |          |      | 012047   | FH8  | 014911   | FH14 |
|          |      |          |      | 012049   | FH8  | 014918   | FH14 |
|          |      |          |      | 012053   | FH8  | 014942   | FH14 |
|          |      |          |      | 012055   | FH8  | 014944   | FH14 |
|          |      |          |      | 012061   | FH8  | 014946   | FH14 |
|          |      |          |      | 012064   | FH11 | 014952   | FH14 |
|          |      |          |      | 012066   | FH11 | 014962   | FH14 |
|          |      |          |      | 012067   | FH7  | 014964   | FH14 |
|          |      |          |      | 012068   | FH11 | 014966   | FH14 |
|          |      |          |      | 012069   | FH11 | 014968   | FH14 |
|          |      |          |      | 012071   | FH7  | 014984   | FH14 |
|          |      |          |      | 012073   | FH7  | 014986   | FH14 |
|          |      |          |      | 012087   | FH7  | 014988   | FH14 |
|          |      |          |      | 012091   | FH7  | 015906   | FH14 |
|          |      |          |      | 012093   | FH7  | 015908   | FH14 |
|          |      |          |      | 012095   | FH7  | 015942   | FH14 |
|          |      |          |      | 012097   | FH7  | 015944   | FH14 |
|          |      |          |      | 013001   | FH7  | 015964   | FH14 |
|          |      |          |      | 013003   | FH7  | 015966   | FH14 |
|          |      |          |      | 013011   | FH7  | 015986   | FH14 |
|          |      |          |      | 013041   | FH8  | 015988   | FH14 |
|          |      |          |      | 013049   | FH8  | 016001   | FH12 |
|          |      |          |      | 013057   | FH8  | 016002   | FH12 |
|          |      |          |      | 013060   | FH8  | 016003   | FH12 |
|          |      |          |      | 013075   | FH7  | 016004   | FH12 |
|          |      |          |      | 013076   | FH7  | 016005   | FH12 |
|          |      |          |      | 013077   | FH7  | 016033   | FH12 |
|          |      |          |      | 014106   | FH14 | 016037   | FH12 |
|          |      |          |      | 014200   | FH14 | 016038   | FH12 |
|          |      |          |      | 014204   | FH14 | 016039   | FH12 |
|          |      |          |      | 014206   | FH14 | 016040   | FH12 |
|          |      |          |      | 014208   | FH14 | 016041   | FH12 |
|          |      |          |      | 014209   | FH14 | 016042   | FH12 |
|          |      |          |      | 014210   | FH14 | 016043   | FH12 |
|          |      |          |      | 014211   | FH14 | 016044   | FH12 |



Call the Velvac Sales Team: **800.783.8871** [sales@velvac.com](mailto:sales@velvac.com)

## PARTS INDEX

| PART NO. | PAGE | PART NO. | PAGE | PART NO. | PAGE | PART NO. | PAGE | PART NO. | PAGE |
|----------|------|----------|------|----------|------|----------|------|----------|------|
| 016045   | FH12 | 016206   | FH5  | 016406   | FH3  | 016818   | FH6  | 017051   | FH13 |
| 016046   | FH12 | 016208   | FH5  | 016407   | FH3  | 016840   | FH3  | 017053   | FH13 |
| 016047   | FH12 | 016212   | FH2  | 016408   | FH4  | 016842   | FH6  | 017055   | FH13 |
| 016051   | FH12 | 016214   | FH2  | 016409   | FH3  | 016844   | FH6  | 017056   | FH13 |
| 016052   | FH12 | 016222   | FH2  | 016412   | FH2  | 016846   | FH6  | 017057   | FH13 |
| 016053   | FH12 | 016240   | FH7  | 016415   | FH4  | 016860   | FH3  | 017058   | FH13 |
| 016054   | FH12 | 016242   | FH2  | 016416   | FH4  | 016862   | FH6  | 017059   | FH13 |
| 016065   | FH12 | 016244   | FH2  | 016417   | FH4  | 016864   | FH6  | 017061   | FH13 |
| 016067   | FH13 | 016246   | FH2  | 016440   | FH7  | 016866   | FH6  | 017063   | FH13 |
| 016068   | FH13 | 016247   | FH3  | 016442   | FH2  | 016868   | FH6  | 017064   | FH7  |
| 016069   | FH13 | 016248   | FH3  | 016444   | FH2  | 016880   | FH3  | 017065   | FH13 |
| 016070   | FH13 | 016249   | FH3  | 016446   | FH2  | 016884   | FH6  | 017066   | FH7  |
| 016077   | FH13 | 016250   | FH3  | 016450   | FH2  | 016886   | FH6  | 017067   | FH13 |
| 016079   | FH12 | 016254   | FH2  | 016451   | FH2  | 016888   | FH6  | 017069   | FH13 |
| 016080   | FH12 | 016260   | FH7  | 016452   | FH2  | 016890   | FH6  | 017072   | FH13 |
| 016081   | FH12 | 016262   | FH2  | 016453   | FH2  | 016908   | FH6  | 017075   | FH12 |
| 016082   | FH12 | 016264   | FH2  | 016454   | FH2  | 016910   | FH2  | 017077   | FH12 |
| 016083   | FH12 | 016266   | FH2  | 016455   | FH2  | 016912   | FH6  | 017078   | FH12 |
| 016084   | FH12 | 016268   | FH2  | 016456   | FH2  | 016916   | FH6  | 017081   | FH13 |
| 016085   | FH12 | 016270   | FH2  | 016457   | FH2  | 016918   | FH6  | 017083   | FH13 |
| 016086   | FH12 | 016271   | FH2  | 016460   | FH7  | 016920   | FH2  | 017085   | FH13 |
| 016087   | FH12 | 016276   | FH2  | 016464   | FH2  | 016922   | FH6  | 017086   | FH7  |
| 016088   | FH12 | 016277   | FH2  | 016466   | FH2  | 016930   | FH2  | 017089   | FH13 |
| 016089   | FH12 | 016278   | FH2  | 016480   | FH7  | 016940   | FH2  | 017090   | FH13 |
| 016100   | FH7  | 016279   | FH2  | 016481   | FH7  | 016942   | FH6  | 017091   | FH13 |
| 016101   | FH7  | 016280   | FH7  | 016482   | FH7  | 016944   | FH6  | 017093   | FH13 |
| 016102   | FH3  | 016281   | FH2  | 016486   | FH2  | 016945   | FH14 | 017094   | FH13 |
| 016103   | FH3  | 016282   | FH4  | 016510   | FH6  | 016946   | FH6  | 017095   | FH13 |
| 016104   | FH3  | 016283   | FH4  | 016540   | FH6  | 016947   | FH2  | 017096   | FH13 |
| 016105   | FH3  | 016284   | FH2  | 016560   | FH6  | 016948   | FH14 | 017098   | FH10 |
| 016110   | FH3  | 016286   | FH2  | 016580   | FH6  | 016950   | FH2  | 017099   | FH10 |
| 016112   | FH3  | 016288   | FH2  | 016610   | FH3  | 016951   | FH3  | 017101   | FH13 |
| 016114   | FH3  | 016289   | FH2  | 016618   | FH6  | 016960   | FH2  | 017102   | FH13 |
| 016115   | FH4  | 016290   | FH2  | 016620   | FH3  | 016962   | FH6  | 017103   | FH13 |
| 016116   | FH4  | 016291   | FH2  | 016621   | FH3  | 016964   | FH6  | 017106   | FH13 |
| 016117   | FH4  | 016294   | FH3  | 016622   | FH3  | 016966   | FH6  | 017107   | FH13 |
| 016120   | FH3  | 016295   | FH3  | 016623   | FH3  | 016968   | FH6  | 017108   | FH13 |
| 016121   | FH3  | 016300   | FH7  | 016624   | FH3  | 016980   | FH2  | 017109   | FH13 |
| 016122   | FH3  | 016301   | FH7  | 016630   | FH3  | 016982   | FH2  | 017110   | FH13 |
| 016124   | FH3  | 016305   | FH4  | 016640   | FH3  | 016984   | FH6  | 017142   | FH7  |
| 016140   | FH7  | 016312   | FH4  | 016642   | FH6  | 016985   | FH2  | 017144   | FH7  |
| 016142   | FH3  | 016314   | FH4  | 016644   | FH6  | 016986   | FH6  | 017164   | FH7  |
| 016144   | FH3  | 016340   | FH7  | 016660   | FH3  | 016988   | FH6  | 017166   | FH7  |
| 016146   | FH3  | 016342   | FH4  | 016662   | FH6  | 017000   | FH12 | 017186   | FH7  |
| 016160   | FH7  | 016343   | FH4  | 016664   | FH6  | 017003   | FH12 | 017188   | FH7  |
| 016161   | FH3  | 016344   | FH4  | 016666   | FH6  | 017004   | FH12 | 017218   | FH6  |
| 016162   | FH3  | 016348   | FH3  | 016670   | FH3  | 017005   | FH12 | 017223   | FH12 |
| 016163   | FH3  | 016360   | FH7  | 016680   | FH3  | 017006   | FH12 | 017224   | FH12 |
| 016164   | FH3  | 016364   | FH4  | 016686   | FH6  | 017015   | FH13 | 017225   | FH12 |
| 016166   | FH3  | 016366   | FH4  | 016688   | FH6  | 017017   | FH13 | 017226   | FH12 |
| 016168   | FH3  | 016368   | FH4  | 016806   | FH6  | 017019   | FH13 | 017227   | FH12 |
| 016180   | FH7  | 016380   | FH7  | 016808   | FH6  | 017021   | FH13 | 017242   | FH6  |
| 016184   | FH3  | 016386   | FH4  | 016809   | FH6  | 017023   | FH12 | 017244   | FH6  |
| 016186   | FH3  | 016388   | FH4  | 016810   | FH3  | 017025   | FH12 | 017262   | FH6  |
| 016187   | FH3  | 016400   | FH3  | 016811   | FH6  | 017027   | FH12 | 017264   | FH6  |
| 016188   | FH3  | 016401   | FH3  | 016812   | FH3  | 017029   | FH12 | 017266   | FH6  |
| 016189   | FH3  | 016402   | FH3  | 016813   | FH3  | 017031   | FH13 | 017286   | FH6  |
| 016200   | FH7  | 016403   | FH3  | 016814   | FH3  | 017039   | FH13 | 017288   | FH6  |
| 016201   | FH7  | 016404   | FH3  | 016815   | FH3  | 017043   | FH7  | 017808   | FH6  |
| 016204   | FH5  | 016405   | FH3  | 016816   | FH3  | 017046   | FH7  | 017816   | FH6  |

## PARTS INDEX

| PART NO. | PAGE | PART NO. | PAGE | PART NO. | PAGE | PART NO. | PAGE | PART NO. | PAGE |
|----------|------|----------|------|----------|------|----------|------|----------|------|
| 017842   | FH6  | 017984   | FH4  | 020055-7 | A7   | 021017   | E36  | 022106   | FH19 |
| 017844   | FH6  | 017985   | FH4  | 020057   | A7   | 021019   | E36  | 022108   | FH19 |
| 017862   | FH6  | 017991   | FH4  | 020057-7 | A7   | 021021   | E36  | 022110   | FH19 |
| 017864   | FH6  | 017992   | FH4  | 020059   | A7   | 021023   | E36  | 022112   | FH19 |
| 017866   | FH6  | 017993   | FH4  | 020059-7 | A7   | 021059   | E36  | 022116   | FH19 |
| 017868   | FH6  | 017994   | FH4  | 020062   | A7   | 021061   | E36  | 022120   | FH19 |
| 017884   | FH6  | 017995   | FH4  | 020062-7 | A7   | 021063   | E36  | 022124   | FH19 |
| 017886   | FH6  | 017996   | FH4  | 020064   | A7   | 021065   | E36  | 022128   | FH19 |
| 017888   | FH6  | 018006   | FH13 | 020064-6 | A7   | 021070   | E36  | 022132   | FH19 |
| 017900   | FH4  | 018007   | FH13 | 020065   | A7   | 021100   | E36  | 022136   | FH19 |
| 017901   | FH4  | 018008   | FH13 | 020066   | A7   | 021102   | E36  | 022140   | FH19 |
| 017902   | FH4  | 018009   | FH12 | 020104   | E32  | 021103   | E36  | 022144   | FH19 |
| 017910   | FH5  | 018010   | FH12 | 020104-7 | E32  | 021104   | E36  | 022148   | FH19 |
| 017911   | FH5  | 018011   | FH12 | 020106   | E32  | 021105   | E36  | 022204   | FH19 |
| 017912   | FH5  | 018012   | FH12 | 020106-7 | E32  | 021106   | E36  | 022206   | FH19 |
| 017913   | FH5  | 018013   | FH13 | 020108   | E32  | 021107   | E36  | 022306   | FH19 |
| 017914   | FH5  | 018023   | FH12 | 020108-7 | E32  | 021108   | E36  | 022308   | FH19 |
| 017920   | FH5  | 018025   | FH13 | 020110   | E32  | 021109   | E36  | 022310   | FH19 |
| 017921   | FH5  | 018026   | FH13 | 020110-7 | E32  | 021110   | E36  | 022312   | FH19 |
| 017922   | FH5  | 018027   | FH13 | 020112   | E32  | 021111   | E36  | 022316   | FH19 |
| 017931   | FH5  | 018029   | FH13 | 020112-7 | E32  | 021112   | E36  | 022320   | FH19 |
| 017932   | FH5  | 018030   | FH13 | 020116-7 | E32  | 021113   | E36  | 022324   | FH19 |
| 017940   | FH5  | 018034   | FH13 | 020117-7 | E32  | 021114   | E36  | 022328   | FH19 |
| 017941   | FH5  | 018035   | FH13 | 020118-7 | E32  | 021115   | E36  | 022332   | FH19 |
| 017942   | FH5  | 018036   | FH13 | 020119-7 | E32  | 021116   | E36  | 022336   | FH19 |
| 017943   | FH5  | 018037   | FH13 | 020132   | A7   | 021117   | E36  | 022340   | FH19 |
| 017944   | FH5  | 018038   | FH13 | 020134   | A7   | 021118   | E36  | 022344   | FH19 |
| 017945   | FH5  | 019003   | FH24 | 020134-6 | A7   | 021119   | E36  | 022348   | FH19 |
| 017946   | FH5  | 019004   | FH24 | 020136   | A7   | 022001   | A9   | 022352   | FH19 |
| 017947   | FH5  | 019006   | FH24 | 020136-7 | A7   | 022002   | A9   | 022356   | FH19 |
| 017950   | FH5  | 019009   | FH24 | 020138   | A7   | 022004   | A9   | 022360   | FH19 |
| 017951   | FH5  | 019011   | FH24 | 020138-7 | A7   | 022005   | A9   | 022364   | FH19 |
| 017952   | FH5  | 019013   | FH24 | 020142   | A7   | 022008   | A9   | 022372   | FH19 |
| 017953   | FH5  | 019015   | FH24 | 020144   | A7   | 022009   | A9   | 022380   | FH19 |
| 017954   | FH5  | 019017   | FH24 | 020144-6 | A7   | 022011   | A5   | 022388   | FH19 |
| 017955   | FH5  | 019032   | AC4  | 020146   | A7   | 022011-7 | A5   | 022396   | FH19 |
| 017956   | FH5  | 019049   | FH24 | 020146-7 | A7   | 022025   | A9   | 022400   | FH21 |
| 017957   | FH5  | 019050   | FH24 | 020154   | A7   | 022026   | A9   | 022404   | FH19 |
| 017958   | FH5  | 019051   | FH24 | 020154-6 | A7   | 022027   | A9   | 022410   | FH21 |
| 017959   | FH5  | 019057   | FH25 | 020156   | A7   | 022028   | A8   | 022412   | FH21 |
| 017960   | FH5  | 019058   | FH25 | 020156-7 | A7   | 022030   | A9   | 022416   | FH21 |
| 017961   | FH5  | 019059   | FH25 | 020157   | A7   | 022031   | A9   | 022420   | FH21 |
| 017962   | FH5  | 019060   | FH25 | 020158   | A7   | 022032   | A9   | 022424   | FH21 |
| 017963   | FH5  | 019061   | FH25 | 020158-7 | A7   | 022047   | A5   | 022425   | FH21 |
| 017964   | FH5  | 019062   | FH25 | 020164   | A7   | 022047-7 | A5   | 022430   | FH21 |
| 017965   | FH5  | 019064   | FH25 | 020164-6 | A7   | 022048   | FH22 | 022435   | FH21 |
| 017966   | FH5  | 019065   | FH25 | 020166   | A7   | 022049   | FH22 | 022440   | FH21 |
| 017967   | FH5  | 019067   | FH25 | 020166-7 | A7   | 022050   | FH22 | 022445   | FH21 |
| 017967   | FH5  | 019069   | FH25 | 020168   | A7   | 022051   | FH22 | 022450   | FH21 |
| 017970   | FH4  | 019070   | FH25 | 020168-7 | A7   | 022052   | FH22 | 022462   | FH21 |
| 017972   | FH4  | 019071   | FH25 | 021001   | E36  | 022053   | FH22 | 022463   | FH21 |
| 017973   | FH4  | 019072   | FH25 | 021003   | E36  | 022054   | FH22 | 022464   | FH21 |
| 017974   | FH4  | 019073   | FH25 | 021005   | E36  | 022055   | FH22 | 022465   | FH21 |
| 017980   | FH4  | 019088   | FH24 | 021007   | E36  | 022056   | FH22 | 022470   | FH23 |
| 017981   | FH4  | 020052   | A7   | 021009   | E36  | 022057   | FH22 | 022471   | FH23 |
| 017982   | FH4  | 020053   | A7   | 021011   | E36  | 022058   | FH22 | 022472   | FH23 |
| 017983   | FH4  | 020053-7 | A7   | 021013   | E36  | 022059   | FH22 | 022473   | FH23 |
|          |      | 020055   | A7   | 021015   | E36  | 022060   | FH22 | 022474   | FH23 |



Call the Velvac Sales Team: **800.783.8871** [sales@velvac.com](mailto:sales@velvac.com)

| PART NO. | PAGE | PART NO. | PAGE | PART NO. | PAGE | PART NO. | PAGE | PART NO. | PAGE |
|----------|------|----------|------|----------|------|----------|------|----------|------|
| 022475   | FH23 | 023066   | FH23 | 032195   | A22  | 034033   | A15  | 034113   | A20  |
| 022476   | FH23 | 023106   | FH23 | 032201   | A23  | 034034   | A15  | 034114   | A20  |
| 022477   | FH23 | 023108   | FH23 | 032205   | A23  | 034035   | A15  | 034122   | A20  |
| 022478   | FH23 | 023126   | FH23 | 032206   | A23  | 034036   | A16  | 034123   | A20  |
| 022506   | FH19 | 023128   | FH23 | 032216   | A23  | 034037   | A23  | 034124   | A20  |
| 022508   | FH19 | 030013   | A27  | 032217   | A23  | 034038   | A15  | 034126   | A20  |
| 022510   | FH19 | 030015   | A27  | 032218   | A23  | 034039   | A15  | 034130   | A21  |
| 022512   | FH19 | 030017   | A27  | 032219   | A23  | 034040   | A15  | 034131   | A21  |
| 022516   | FH19 | 030019   | A27  | 032220   | A23  | 034041   | A24  | 034132   | A21  |
| 022520   | FH19 | 030021   | A27  | 032221   | A23  | 034042   | A24  | 034133   | A21  |
| 022524   | FH19 | 030074   | A25  | 032222   | A23  | 034043   | A26  | 034134   | A21  |
| 022528   | FH19 | 030075   | A25  | 032225   | A19  | 034044   | A26  | 034135   | A21  |
| 022532   | FH19 | 030084   | A28  | 032227   | A19  | 034045   | A26  | 034136   | A21  |
| 022536   | FH19 | 030084   | A29  | 032228   | A19  | 034046   | A25  | 034137   | A20  |
| 022540   | FH19 | 030092   | A28  | 032229   | A19  | 034047   | A25  | 034139   | A33  |
| 022544   | FH19 | 030092   | A28  | 032231   | A19  | 034048   | A25  | 035005   | A3   |
| 022548   | FH19 | 030092   | A29  | 032232   | A19  | 034049   | A12  | 035007   | A3   |
| 022550   | FH20 | 030093   | A28  | 032233   | A19  | 034050   | A12  | 035009   | A3   |
| 022551   | FH20 | 030093   | A29  | 032234   | A19  | 034051   | A11  | 035010   | A3   |
| 022556   | FH19 | 030094   | A29  | 032235   | A19  | 034052   | A12  | 035011   | A3   |
| 022557   | FH20 | 031021   | A27  | 032236   | A19  | 034053   | A12  | 035012   | R7   |
| 022564   | FH19 | 031023   | A27  | 032240   | A22  | 034054   | A12  | 035021   | FH10 |
| 022565   | R7   | 031025   | A27  | 032241   | A22  | 034055   | A11  | 035025   | A4   |
| 022572   | FH19 | 031027   | A27  | 032242   | A22  | 034056   | A13  | 035026   | A4   |
| 022574   | FH19 | 031031   | A27  | 032243   | A22  | 034057   | A13  | 035029   | FH10 |
| 022580   | FH20 | 031033   | A27  | 032244   | A22  | 034058   | A13  | 035031   | A2   |
| 022581   | FH20 | 031035   | A27  | 032245   | A22  | 034059   | A13  | 035032   | A2   |
| 022582   | FH20 | 032015   | A16  | 032246   | A22  | 034062   | A13  | 035033   | A2   |
| 022583   | FH20 | 032018   | A16  | 032247   | A20  | 034063   | A14  | 035036   | A4   |
| 022584   | FH20 | 032019   | A16  | 032248   | A20  | 034064   | A22  | 035037   | A4   |
| 022585   | FH20 | 032020   | A16  | 032249   | A20  | 034065   | A22  | 035038   | A2   |
| 022586   | FH20 | 032022   | A20  | 032250   | A20  | 034066   | A14  | 035042   | A2   |
| 022587   | FH20 | 032023   | A20  | 032253   | A20  | 034067   | A14  | 035045   | A2   |
| 022588   | FH20 | 032037   | A19  | 032400   | A19  | 034068   | A12  | 035065   | A24  |
| 022589   | FH20 | 032039   | A19  | 032401   | A19  | 034069   | A14  | 035070   | A4   |
| 022591   | FH20 | 032051   | A17  | 032402   | A19  | 034070   | A18  | 035079   | FH10 |
| 022592   | FH20 | 032058   | A26  | 032403   | A19  | 034071   | A18  | 035081   | FH9  |
| 022593   | FH20 | 032060   | A24  | 032404   | A19  | 034072   | A18  | 035087   | FH9  |
| 022594   | FH20 | 032081   | A26  | 032405   | A19  | 034073   | A18  | 035092   | A2   |
| 022596   | FH20 | 032082   | A26  | 032406   | A19  | 034074   | A23  | 035093   | A2   |
| 022597   | FH20 | 032083   | A26  | 034012   | A16  | 034075   | A17  | 035094   | A2   |
| 022598   | FH20 | 032086   | A23  | 034013   | A11  | 034077   | A15  | 035095   | A2   |
| 022626   | FH20 | 032110   | A23  | 034014   | A11  | 034078   | A16  | 035100   | A4   |
| 022627   | FH20 | 032131   | A14  | 034015   | A11  | 034079   | A11  | 035101   | A27  |
| 022628   | R8   | 032135   | A26  | 034016   | A11  | 034080   | A11  | 035102   | A27  |
| 022630   | R8   | 032139   | A22  | 034017   | A11  | 034081   | A12  | 035103   | A27  |
| 022633   | A10  | 032140   | A22  | 034018   | A11  | 034082   | A12  | 035104   | A27  |
| 022634   | A10  | 032141   | A22  | 034019   | A11  | 034083   | A14  | 035105   | A27  |
| 022635   | A10  | 032142   | A18  | 034020   | A13  | 034084   | A16  | 035106   | A27  |
| 022636   | A10  | 032143   | A18  | 034021   | A13  | 034085   | A12  | 035107   | A27  |
| 022637   | A10  | 032144   | A18  | 034023   | A13  | 034087   | A25  | 035108   | A27  |
| 022638   | A10  | 032145   | A18  | 034024   | A13  | 034088   | A25  | 035109   | A27  |
| 022639   | A10  | 032146   | A18  | 034025   | A13  | 034089   | A25  | 035140   | A3   |
| 022640   | A10  | 032160   | A26  | 034026   | A13  | 034090   | A25  | 035141   | A3   |
| 022641   | A10  | 032170   | A26  | 034027   | A13  | 034091   | A25  | 035142   | A3   |
| 022642   | A10  | 032185   | A26  | 034028   | A13  | 034092   | A25  | 035143   | A3   |
| 022643   | A10  | 032190   | A17  | 034029   | A14  | 034095   | F7   | 035144   | A3   |
| 022644   | A10  | 032191   | A17  | 034030   | A15  | 034101   | A20  | 035145   | A3   |
| 022680   | FH19 | 032192   | A17  | 034031   | A15  | 034111   | A20  | 035146   | A3   |
| 022688   | FH19 | 032194   | A17  | 034032   | A15  | 034112   | A20  | 035147   | A3   |

## PARTS INDEX

| PART NO. | PAGE | PART NO. | PAGE | PART NO.  | PAGE | PART NO.  | PAGE | PART NO.   | PAGE |
|----------|------|----------|------|-----------|------|-----------|------|------------|------|
| 035150   | A4   | 051066   | E33  | 055043    | E7   | 055109-10 | E27  | 056053-50  | E25  |
| 035150-6 | A4   | 051101   | E31  | 055045    | E6   | 055110-10 | E27  | 056054-10  | E25  |
| 035151   | A2   | 051103   | E31  | 055049    | E4   | 055111-10 | E27  | 056055-10  | E25  |
| 035152   | A2   | 051105   | E31  | 055050    | E4   | 055112-10 | E27  | 056056-10  | E25  |
| 035160   | R6   | 051117   | E31  | 055051    | E4   | 055113-10 | E27  | 056060-50  | E29  |
| 035161   | R6   | 051117-6 | E31  | 055052    | E7   | 055114-10 | E26  | 056061-50  | E29  |
| 035162   | R6   | 051119   | E31  | 055053    | E7   | 055115-10 | E26  | 056062-50  | E29  |
| 035163   | R6   | 051119-6 | E31  | 055054    | E4   | 055116-10 | E26  | 056063-50  | E29  |
| 035164   | A3   | 051121   | E31  | 055056    | E7   | 055117-10 | E26  | 056064-50  | E29  |
| 035165   | A3   | 051121-6 | E31  | 055059    | E4   | 055118-10 | E29  | 056065-50  | E29  |
| 035166   | A3   | 051123   | E31  | 055060    | E21  | 055119-10 | E29  | 056066-50  | E29  |
| 035167   | A3   | 051123-6 | E31  | 055062    | E7   | 055120-10 | E27  | 056067-50  | E29  |
| 035168   | A3   | 051125   | E31  | 055063    | E7   | 055121-10 | E27  | 056068-50  | E29  |
| 035169   | A2   | 051127   | E31  | 055064-10 | E28  | 055122-10 | E27  | 056069-50  | E29  |
| 035170   | A2   | 051129   | E31  | 055065-10 | E28  | 055123-10 | E27  | 056070-50  | E29  |
| 035173   | A2   | 051135   | E31  | 055066-10 | E28  | 055124-10 | E27  | 056071-50  | E29  |
| 035174   | A2   | 051135-6 | E31  | 055067-10 | E25  | 055125-10 | E26  | 056076-50  | E26  |
| 035175   | A4   | 051137   | E31  | 055068-10 | E25  | 055126-10 | E26  | 056078-50  | E26  |
| 035176   | A4   | 051137-6 | E31  | 055069-10 | E25  | 055127-10 | E26  | 056080-50  | E26  |
| 035177   | A4   | 051139   | E31  | 055070-10 | E25  | 055128-10 | E29  | 056082-10  | E28  |
| 035178   | A4   | 051139-6 | E31  | 055071-10 | E25  | 055129-10 | E29  | 056083-10  | E28  |
| 035179   | A2   | 051141   | E31  | 055075-10 | E25  | 055130-10 | E27  | 056084-10  | E28  |
| 035180   | A2   | 051141-6 | E31  | 055075-50 | E25  | 055131-10 | E27  | 056086-50  | E29  |
| 035181   | A2   | 051143   | E31  | 055076-10 | E25  | 055132-10 | E27  | 056088-50  | E29  |
| 035182   | A2   | 051143-6 | E31  | 055076-50 | E25  | 055133-10 | E27  | 056093-50  | E28  |
| 036003   | A26  | 051145   | E31  | 055077-10 | E25  | 055134-10 | E27  | 056094-10  | E28  |
| 036019   | A26  | 051145-6 | E31  | 055077-50 | E25  | 055135-10 | E26  | 056096     | E30  |
| 036020   | A26  | 051147   | E31  | 055078-10 | E26  | 055136-10 | E29  | 056097     | E30  |
| 036021   | A26  | 051147-6 | E31  | 055079-10 | E26  | 055137-10 | E29  | 056107     | E30  |
| 036036   | A24  | 051153   | E31  | 055080-10 | E26  | 056001-50 | E27  | 056108     | E30  |
| 036043   | A24  | 051155   | E31  | 055081-10 | E26  | 056002-50 | E27  | 056109     | E30  |
| 036045   | A24  | 051155-7 | E31  | 055082-10 | E26  | 056003-50 | E27  | 056111-100 | E25  |
| 036049   | A24  | 051157   | E31  | 055083-10 | E26  | 056004-50 | E27  | 056111-5   | E25  |
| 038001   | H3   | 051157-7 | E31  | 055084-10 | E28  | 056006-50 | E27  | 056112-100 | E25  |
| 038003   | H3   | 051159   | E31  | 055085-10 | E28  | 056007-50 | E27  | 056112-5   | E25  |
| 038005   | H3   | 051159-7 | E31  | 055086-10 | E28  | 056008-50 | E27  | 056113-100 | E25  |
| 038008   | H3   | 051161   | E31  | 055087-10 | E28  | 056009-50 | E27  | 056113-5   | E25  |
| 050001   | E8   | 051161-7 | E31  | 055088-10 | E28  | 056010-50 | E27  | 056144-25  | E25  |
| 050001-7 | E8   | 051163   | E31  | 055089-10 | E28  | 056011-50 | E27  | 056145-25  | E25  |
| 050007   | E8   | 051163-7 | E31  | 055090-10 | E28  | 056012-50 | E27  | 056146-25  | E25  |
| 050007-7 | E8   | 051165   | E31  | 055091-10 | E28  | 056033    | E10  | 056147-25  | E28  |
| 050019   | E8   | 051171   | E31  | 055092-10 | E28  | 056034    | E10  | 056149-25  | E28  |
| 050019-7 | E8   | 051171-7 | E31  | 055093-10 | E28  | 056035    | E10  | 056150-25  | E28  |
| 050029   | E2   | 051173   | E31  | 055094-10 | E28  | 056036    | E10  | 056151-25  | E28  |
| 050037   | E8   | 051175   | E31  | 055095-10 | E28  | 056037    | E10  | 056152-25  | E28  |
| 050042   | E8   | 051175-7 | E31  | 055096-10 | E28  | 056038    | E10  | 056153-25  | E28  |
| 050042-7 | E8   | 051177   | E31  | 055097-10 | E28  | 056039    | E10  | 056154-25  | E28  |
| 050051   | E8   | 051177-7 | E31  | 055098-10 | E29  | 056040    | E10  | 056155-25  | E26  |
| 050052   | E8   | 054001   | E4   | 055099-10 | E29  | 056041    | E10  | 056156-25  | E26  |
| 051050   | E33  | 054002   | E6   | 055100-10 | E29  | 056042    | E10  | 056157-25  | E26  |
| 051050-7 | E33  | 054003   | E5   | 055101-10 | E29  | 056043-50 | E26  | 056158-25  | E29  |
| 051052   | E33  | 054017   | E7   | 055102-10 | E29  | 056044-50 | E26  | 056159-25  | E29  |
| 051054   | E33  | 055034   | E5   | 055103-10 | E29  | 056045-50 | E26  | 056160-25  | E29  |
| 051058   | E33  | 055037   | E6   | 055104-10 | E26  | 056046-50 | E26  | 056164-25  | E29  |
| 051058-7 | E33  | 055038   | E6   | 055105-10 | E26  | 056047-50 | E26  | 056165-25  | E29  |
| 051060   | E33  | 055039   | E6   | 055106-10 | E25  | 056049-50 | E27  | 056166-25  | E29  |
| 051062   | E33  | 055040   | E6   | 055107-10 | E25  | 056051-50 | E25  | 056167-25  | E29  |
|          |      | 055041   | E6   | 055108-10 | E25  | 056052-50 | E25  | 056168-25  | E29  |



Call the Velvac Sales Team: **800.783.8871** [sales@velvac.com](mailto:sales@velvac.com)



## PARTS INDEX

| PART NO.  | PAGE | PART NO.  | PAGE | PART NO. | PAGE | PART NO.  | PAGE | PART NO.  | PAGE |
|-----------|------|-----------|------|----------|------|-----------|------|-----------|------|
| 056169-25 | E29  | 057116-10 | E34  | 058039   | E8   | 058241    | E8   | 058363-10 | E28  |
| 056184-50 | E28  | 057117    | E35  | 058039-7 | E8   | 058241-7  | E8   | 058364-50 | E28  |
| 056185-50 | E28  | 057117-10 | E34  | 058041   | E8   | 058243    | E8   | 058365-50 | E28  |
| 056186-50 | E28  | 057118    | E5   | 058041-7 | E8   | 058243-7  | E8   | 058366-40 | E28  |
| 057002    | E10  | 057119    | E5   | 058043   | E8   | 058245    | E8   | 058367-10 | E28  |
| 057003    | E22  | 057120    | E5   | 058043-7 | E8   | 058247    | E8   | 058370    | AC7  |
| 057050    | E11  | 057121    | E5   | 058045   | E8   | 058251    | E13  | 058373    | AC7  |
| 057051    | E11  | 057123    | E37  | 058046   | E13  | 058252    | E13  | 058374    | AC7  |
| 057052    | E11  | 057124    | E37  | 058047   | E8   | 058253    | E13  | 058377    | AC7  |
| 057053    | E11  | 057125    | E37  | 058050   | E11  | 058254    | E13  | 058379    | AC7  |
| 057054    | E11  | 057126    | E38  | 058051   | E11  | 058296    | E13  | 058380    | E38  |
| 057055    | E11  | 057127    | E38  | 058052   | E11  | 058301-50 | E28  | 058380-4  | R6   |
| 057056    | E11  | 057128    | E38  | 058053   | E11  | 058302-50 | E28  | 058381    | E38  |
| 057057    | E11  | 057131    | E34  | 058054   | E11  | 058303-50 | E28  | 058381-4  | R6   |
| 057058    | E35  | 057132    | E34  | 058055   | E11  | 058304-50 | E28  | 058382    | E38  |
| 057058-10 | E33  | 057133    | E34  | 058056   | E11  | 058305-50 | E28  | 058395    | AC7  |
| 057059    | E35  | 057146-10 | E33  | 058057   | E11  | 058306-50 | E28  | 058396    | AC7  |
| 057059-10 | E33  | 057147-10 | E34  | 058058   | E11  | 058307-50 | E28  | 058397    | AC7  |
| 057060    | E35  | 057148-5  | E33  | 058068   | E13  | 058308-50 | E28  | 058398    | AC7  |
| 057060-10 | E33  | 057149-25 | E34  | 058071   | E13  | 058309-50 | E26  | 058399    | AC7  |
| 057061-25 | E34  | 057150-25 | E33  | 058073   | E10  | 058310-50 | E26  | 058400    | AC7  |
| 057062-25 | E34  | 057151-25 | E34  | 058074   | E10  | 058311-50 | E26  | 058402    | AC7  |
| 057071    | E37  | 057152-2  | E33  | 058076   | E10  | 058312-50 | E25  | 058416    | E12  |
| 057072    | E37  | 057153-2  | E34  | 058077   | E10  | 058313-40 | E25  | 058417    | E12  |
| 057073    | E35  | 057158    | E35  | 058078   | E10  | 058314-40 | E25  | 058418    | E12  |
| 057073-10 | E34  | 057158-10 | E34  | 058079   | E10  | 058315-40 | E29  | 058419    | E12  |
| 057074    | E35  | 057159-5  | E33  | 058081   | E10  | 058316-40 | E29  | 058420    | E12  |
| 057074-10 | E34  | 057160-2  | E33  | 058082   | E10  | 058317-10 | E29  | 058421    | E12  |
| 057075-50 | E27  | 057174-2  | E34  | 058083   | E10  | 058318-50 | E29  | 058422    | E12  |
| 057076-50 | E27  | 058001    | E11  | 058084   | E10  | 058319-50 | E29  | 058423    | E12  |
| 057077-50 | E27  | 058002    | E11  | 058086   | E10  | 058320-10 | E29  | 058424    | E12  |
| 057078-50 | E27  | 058003    | E11  | 058088   | E10  | 058325    | E10  | 058425    | E12  |
| 057079-50 | E27  | 058004    | E11  | 058090   | E13  | 058326    | E10  | 058426    | E12  |
| 057080-50 | E27  | 058005    | E11  | 058091   | E13  | 058327    | E10  | 058427    | E12  |
| 057081-50 | E27  | 058006    | E11  | 058092   | E13  | 058328    | E10  | 058428    | E12  |
| 057082-50 | E26  | 058007    | E11  | 058093   | E13  | 058329    | E10  | 058429    | E12  |
| 057083-50 | E26  | 058008    | E11  | 058094   | E13  | 058330    | E10  | 058430    | E12  |
| 057084-50 | E26  | 058009    | E11  | 058095   | E13  | 058331    | E10  | 058431    | E12  |
| 057085-50 | E25  | 058010    | E11  | 058115   | E9   | 058332    | E10  | 058432    | E12  |
| 057086-50 | E25  | 058011    | E11  | 058116   | E9   | 058334-50 | E28  | 058433    | E12  |
| 057087-50 | E25  | 058012    | E13  | 058117   | E9   | 058335-50 | E26  | 058434    | E12  |
| 057088-50 | E29  | 058013    | E13  | 058118   | E9   | 058336-50 | E26  | 058435    | E12  |
| 057089-50 | E29  | 058016    | E13  | 058119   | E9   | 058337-50 | E26  | 058436    | E12  |
| 057090-50 | E29  | 058017    | E13  | 058128   | E9   | 058338-50 | E26  | 058437    | E12  |
| 057091-50 | E29  | 058019    | E11  | 058129   | E9   | 058340-50 | E26  | 058438    | E12  |
| 057092-50 | E26  | 058020    | E10  | 058151   | E9   | 058345-50 | E26  | 058439    | E12  |
| 057096-40 | E29  | 058021    | E10  | 058152   | E9   | 058346-10 | E28  | 058440    | E12  |
| 057097-25 | E33  | 058022    | E10  | 058160   | E38  | 058347-40 | E29  | 058441    | E12  |
| 057098-25 | E34  | 058023    | E10  | 058171   | E37  | 058348-40 | E29  | 058442    | E12  |
| 057110    | E35  | 058024    | E10  | 058172   | E37  | 058349-50 | E27  | 058443    | E12  |
| 057111    | E35  | 058026    | E37  | 058173   | E37  | 058350-50 | E27  | 058444    | E12  |
| 057112    | E35  | 058028-50 | E25  | 058212   | E9   | 058351-50 | E27  | 058445    | E12  |
| 057112-10 | E34  | 058029-50 | E25  | 058233   | E8   | 058352-50 | E27  | 058446    | E12  |
| 057113    | E35  | 058030    | E37  | 058233-7 | E8   | 058353-50 | E27  | 058447    | E12  |
| 057113-10 | E34  | 058033    | E8   | 058235   | E8   | 058354-50 | E27  | 058448    | E12  |
| 057114    | E35  | 058033-7  | E8   | 058235-7 | E8   | 058355-50 | E27  | 058449    | E12  |
| 057114-10 | E34  | 058035    | E8   | 058237   | E8   | 058356-50 | E27  | 058450    | E12  |
| 057115    | E35  | 058035-7  | E8   | 058237-7 | E8   | 058357-50 | E27  | 058451    | E12  |
| 057115-10 | E34  | 058037    | E8   | 058239   | E8   | 058358-50 | E27  | 058452    | E12  |
| 057116    | E35  | 058037-7  | E8   | 058239-7 | E8   | 058362-50 | E25  | 060001    | F6   |

## PARTS INDEX

| PART NO.   | PAGE | PART NO. | PAGE | PART NO. | PAGE | PART NO. | PAGE | PART NO.  | PAGE |
|------------|------|----------|------|----------|------|----------|------|-----------|------|
| 060004     | F6   | 090114   | AC5  | 090212   | E14  | 091143-5 | E21  | 091426    | E22  |
| 060007     | F6   | 090115   | AC5  | 090213   | E14  | 091144-5 | E21  | 091427    | E21  |
| 060012     | F6   | 090116   | AC5  | 090214   | E14  | 091173-5 | E21  | 091500-3  | E20  |
| 060026     | F6   | 090119   | AC5  | 090215   | E14  | 091174-5 | E21  | 091501    | E20  |
| 060027     | F6   | 090120   | E14  | 090216   | E6   | 091175-5 | E21  | 091502    | E20  |
| 060033     | F8   | 090123   | E17  | 090217   | E7   | 091177-5 | E21  | 091503    | E20  |
| 060040     | F7   | 090124   | E17  | 090218   | E7   | 091180-5 | E21  | 091504    | E20  |
| 060047     | F7   | 090125   | E17  | 090219   | E17  | 091181-5 | E21  | 091505    | E20  |
| 060049     | F7   | 090128   | E17  | 090220   | E17  | 091182-5 | E21  | 091510-10 | E20  |
| 060050     | F6   | 090136   | E17  | 090221   | E17  | 091183-5 | E21  | 091511-10 | E20  |
| 060051     | F6   | 090142   | AC4  | 090222   | E17  | 091184-5 | E21  | 091512-10 | E20  |
| 060053     | F6   | 090145   | AC4  | 090225   | E16  | 091188   | E22  | 091513-10 | E20  |
| 060056     | F8   | 090147   | E17  | 090226   | E5   | 091189   | E22  | 091514-10 | E20  |
| 060060     | F7   | 090149   | E17  | 090227   | E5   | 091190   | E22  | 100022    | A32  |
| 060061     | F7   | 090150   | E17  | 090233   | E14  | 091201   | E19  | 100028    | A32  |
| 060062     | F7   | 090153   | E17  | 090234   | E14  | 091202   | E19  | 100036    | A32  |
| 060063     | F7   | 090158   | E17  | 090240   | AC4  | 091203   | E19  | 100037    | A32  |
| 060064     | F7   | 090162   | AC4  | 091001   | E23  | 091204   | E19  | 100101    | A32  |
| 060070     | F6   | 090165   | AC4  | 091002   | E23  | 091208   | E19  | 100102    | A32  |
| 060071     | F6   | 090166   | E17  | 091003   | E20  | 091209   | E19  | 100122    | A30  |
| 090002-100 | E35  | 090167   | E17  | 091004   | E20  | 091210   | E19  | 100123    | A30  |
| 090004-100 | E35  | 090168   | E17  | 091005   | E20  | 091211   | E19  | 100124    | A30  |
| 090006-25  | E35  | 090169   | E17  | 091006   | E20  | 091212   | E19  | 100125    | A30  |
| 090010-25  | E35  | 090173   | E14  | 091007   | E20  | 091213   | E19  | 100126    | A30  |
| 090014     | FH16 | 090174   | E14  | 091008   | E20  | 091214   | E19  | 100131    | A30  |
| 090014-100 | E35  | 090176   | E15  | 091011   | E20  | 091215   | E19  | 100132    | A30  |
| 090016-100 | E35  | 090177   | E15  | 091015   | E20  | 091216   | E19  | 100136    | A30  |
| 090028     | A8   | 090179   | E15  | 091020   | E20  | 091225   | E19  | 100137    | A30  |
| 090029-50  | E35  | 090180   | E18  | 091025   | E20  | 091230   | E18  | 100144-7  | A32  |
| 090030-50  | E35  | 090181   | E18  | 091030   | E20  | 091231   | E18  | 100204    | A29  |
| 090040     | E15  | 090182   | AC4  | 091040   | E20  | 091232   | E18  | 100206    | A29  |
| 090043     | E15  | 090184   | E15  | 091050   | E20  | 091233   | E18  | 100208    | A29  |
| 090048     | E15  | 090185   | AC4  | 091051   | E20  | 091235   | E18  | 100226    | A29  |
| 090054     | E16  | 090186   | E15  | 091052   | E20  | 091236   | E18  | 100308    | A29  |
| 090056     | E16  | 090187   | E15  | 091053   | E20  | 091237   | E18  | 100310    | A29  |
| 090060     | AC5  | 090188   | E15  | 091054   | E20  | 091251   | E21  | 100424    | A31  |
| 090061     | AC5  | 090189   | E15  | 091055   | E20  | 091254   | E21  | 100603    | A31  |
| 090064-100 | E35  | 090190   | E14  | 091056   | E20  | 091300-5 | E21  | 100613    | A31  |
| 090066-100 | E35  | 090191   | E15  | 091057   | E20  | 091301-5 | E21  | 100614    | A31  |
| 090067-100 | E35  | 090192   | E15  | 091071   | E20  | 091302-5 | E21  | 100615    | A31  |
| 090068-100 | E35  | 090193   | E15  | 091072   | E20  | 091303-5 | E21  | 101002    | A32  |
| 090070-25  | E35  | 090194   | E15  | 091073   | E20  | 091304-5 | E21  | 101003    | A32  |
| 090071-25  | E35  | 090196   | E15  | 091074   | E20  | 091305-5 | E21  | 101004    | A32  |
| 090073     | E16  | 090197   | E15  | 091075   | E20  | 091306-5 | E21  | 101054    | A32  |
| 090076     | E18  | 090198   | E15  | 091076   | E20  | 091307-5 | E21  | 101055    | A32  |
| 090078     | E16  | 090199   | E15  | 091080   | E20  | 091308-5 | E21  | 101058    | A32  |
| 090079     | E16  | 090200   | E15  | 091081   | E20  | 091309-5 | E21  | 101059    | A32  |
| 090080     | E16  | 090201   | E15  | 091082   | E20  | 091325   | E22  | 101078    | A32  |
| 090081     | E16  | 090202   | E15  | 091083   | E20  | 091326   | E22  | 131012    | A17  |
| 090082     | E16  | 090203   | E15  | 091130   | E22  | 091350   | E20  | 131014    | A17  |
| 090083     | E16  | 090204   | E15  | 091131-5 | E21  | 091351   | E20  | 131016    | A17  |
| 090085     | E16  | 090205   | E15  | 091132-5 | E21  | 091400-5 | E21  | 131045    | A27  |
| 090104     | E14  | 090206   | E15  | 091133-5 | E21  | 091401-5 | E21  | 140000    | FH9  |
| 090109     | E17  | 090207   | E15  | 091135-5 | E21  | 091402-5 | E21  | 140079    | A7   |
| 090110     | E17  | 090208   | E15  | 091137-5 | E21  | 091403-5 | E21  | 140133    | A6   |
| 090111     | E17  | 090209   | E15  | 091140-5 | E21  | 091404-5 | E21  | 140134    | A6   |
| 090113     | AC5  | 090210   | E14  | 091141-5 | E21  | 091406-3 | E21  | 140135    | A6   |
|            |      | 090211   | E14  | 091142-5 | E21  | 091425   | E22  | 140136    | A6   |



Call the Velvac Sales Team: **800.783.8871** [sales@velvac.com](mailto:sales@velvac.com)

| PART NO. | PAGE | PART NO. | PAGE | PART NO. | PAGE | PART NO. | PAGE | PART NO. | PAGE |
|----------|------|----------|------|----------|------|----------|------|----------|------|
| 140139   | A6   | 146072   | A5   | 148044   | A5   | 320125   | A28  | 500052   | FH9  |
| 140140   | A6   | 146084   | A5   | 148046   | A5   | 320132   | A28  | 500053   | FH9  |
| 140141   | A6   | 146518   | A5   | 148048   | A5   | 320133   | A28  | 500054   | FH9  |
| 140142   | A6   | 146520   | A5   | 148054   | A5   | 320146   | A33  | 500055   | FH9  |
| 142001   | FH9  | 146522   | A5   | 148060   | A5   | 320148   | A33  | 500059   | FH9  |
| 142101   | FH10 | 146524   | A5   | 148066   | A5   | 320149   | A24  | 500060   | FH9  |
| 142102   | FH10 | 146526   | A5   | 148072   | A5   | 320170   | A33  | 500061   | FH9  |
| 142103   | FH10 | 146528   | A5   | 148084   | A5   | 320171   | A33  | 500063   | FH9  |
| 142104   | FH10 | 146530   | A5   | 148096   | A5   | 320172   | A33  | 500064   | FH9  |
| 142106   | FH10 | 146532   | A5   | 148518   | A5   | 320173   | A33  | 500065   | FH9  |
| 142107   | FH10 | 146534   | A5   | 148520   | A5   | 320175   | A28  | 500066   | FH9  |
| 142108   | FH10 | 146536   | A5   | 148522   | A5   | 320176   | A28  | 500070   | FH9  |
| 142109   | FH10 | 146538   | A5   | 148524   | A5   | 320177   | A28  | 500071   | FH9  |
| 142110   | FH10 | 146540   | A5   | 148526   | A5   | 320178   | A28  | 500078   | FH9  |
| 142111   | FH10 | 146542   | A5   | 148528   | A5   | 320179   | A28  | 500079   | FH9  |
| 142113   | A6   | 146544   | A5   | 148530   | A5   | 320180   | A28  | 500080   | FH9  |
| 142113-7 | A6   | 146546   | A5   | 148532   | A5   | 320181   | A34  | 500081   | FH9  |
| 142114   | A6   | 146548   | A5   | 148534   | A5   | 320182   | A34  | 500082   | FH9  |
| 142118   | A6   | 146554   | A5   | 148536   | A5   | 320183   | A34  | 500083   | FH9  |
| 142124   | A6   | 146560   | A5   | 148538   | A5   | 320184   | A33  | 500084   | FH9  |
| 142130   | A6   | 146572   | A5   | 148540   | A5   | 320185   | A34  | 500085   | FH9  |
| 142136   | A6   | 146584   | A5   | 148542   | A5   | 320186   | A34  | 500088   | FH9  |
| 142148   | A6   | 146596   | A5   | 148544   | A5   | 320187   | A28  | 500094   | FH8  |
| 142324   | A6   | 147009   | A5   | 148546   | A5   | 320188   | A33  | 500096   | FH10 |
| 142336   | A6   | 147012   | A5   | 148548   | A5   | 320189   | A34  | 501051   | A27  |
| 142436   | A6   | 147016   | A5   | 148554   | A5   | 320190   | A34  | 501071   | FH9  |
| 142518   | A6   | 147018   | A5   | 148560   | A5   | 320191   | A34  | 580009   | A4   |
| 142524   | A6   | 147020   | A5   | 148572   | A5   | 320192   | A33  | 580037   | H2   |
| 142536   | A6   | 147022   | A5   | 148584   | A5   | 321034   | A28  | 580038   | H2   |
| 142552   | A6   | 147024   | A5   | 148596   | A5   | 351108   | V11  | 580039   | H2   |
| 142554   | A6   | 147026   | A5   | 149001   | A8   | 351109   | V11  | 580040   | H2   |
| 142572   | A6   | 147028   | A5   | 149002   | A8   | 409904   | R5   | 580041   | H2   |
| 142584   | A6   | 147030   | A5   | 149005   | FH10 | 500001   | FH8  | 580042   | A4   |
| 142618   | A6   | 147032   | A5   | 149006   | FH10 | 500003   | FH9  | 580043   | H2   |
| 142624   | A6   | 147034   | A5   | 149018   | A5   | 500004   | FH9  | 580044   | H3   |
| 145110   | A8   | 147036   | A5   | 149020   | A5   | 500005   | FH9  | 580066   | H2   |
| 145112   | A8   | 147038   | A5   | 149024   | A5   | 500007   | A7   | 580067   | H2   |
| 145115   | A8   | 147040   | A5   | 149026   | A5   | 500008   | A7   | 580076   | H2   |
| 145120   | A8   | 147042   | A5   | 149028   | A5   | 500009   | FH8  | 580078   | H2   |
| 145212   | A8   | 147044   | A5   | 149030   | A5   | 500011   | FH9  | 580081   | H2   |
| 145215   | A8   | 147046   | A5   | 149032   | A5   | 500015   | FH8  | 580082   | H2   |
| 146018   | A5   | 147048   | A5   | 149034   | A5   | 500017   | FH9  | 580086   | H2   |
| 146020   | A5   | 147054   | A5   | 149036   | A5   | 500019   | FH9  | 580094   | H2   |
| 146022   | A5   | 147060   | A5   | 149042   | A5   | 500021   | FH9  | 580107   | H2   |
| 146024   | A5   | 147072   | A5   | 149046   | A5   | 500022   | FH9  | 580111   | H2   |
| 146026   | A5   | 148012   | A5   | 149048   | A5   | 500024   | FH9  | 580112   | H2   |
| 146028   | A5   | 148016   | A5   | 149060   | A5   | 500025   | FH9  | 580113   | AC3  |
| 146030   | A5   | 148018   | A5   | 149072   | A5   | 500027   | FH9  | 580114   | AC3  |
| 146032   | A5   | 148020   | A5   | 149119   | A5   | 500030   | FH9  | 580115   | AC3  |
| 146034   | A5   | 148022   | A5   | 149120   | A5   | 500031   | FH9  | 580116   | AC3  |
| 146036   | A5   | 148024   | A5   | 149121   | A5   | 500033   | FH9  | 580117   | AC3  |
| 146038   | A5   | 148026   | A5   | 149122   | A5   | 500035   | FH9  | 580118   | AC3  |
| 146040   | A5   | 148028   | A5   | 149123   | A5   | 500037   | FH9  | 580119   | AC3  |
| 146042   | A5   | 148030   | A5   | 149124   | A5   | 500039   | FH8  | 580120   | AC3  |
| 146044   | A5   | 148032   | A5   | 149125   | A5   | 500041   | FH9  | 580121   | AC3  |
| 146046   | A5   | 148034   | A5   | 149126   | A8   | 500042   | FH9  | 580122   | AC3  |
| 146048   | A5   | 148036   | A5   | 320001   | A26  | 500044   | FH8  | 580123   | A4   |
| 146052   | A5   | 148038   | A5   | 320003   | A26  | 500046   | FH8  | 581001   | H4   |
| 146054   | A5   | 148040   | A5   | 320014   | A26  | 500050   | FH8  | 581005   | H4   |
| 146060   | A5   | 148042   | A5   | 320051   | A17  | 500051   | FH8  | 581006   | H4   |

## PARTS INDEX

| PART NO. | PAGE | PART NO. | PAGE | PART NO. | PAGE | PART NO. | PAGE | PART NO. | PAGE |
|----------|------|----------|------|----------|------|----------|------|----------|------|
| 581006   | A4   | 591022   | E7   | 600242   | F5   | 697002   | B2   | 704070   | M129 |
| 581011   | H4   | 591090   | E6   | 600243   | F5   | 697011   | B2   | 704077   | M21  |
| 581015   | H4   | 591105   | E4   | 600244   | F5   | 697012   | B2   | 704078   | M21  |
| 581038   | H4   | 591113   | E6   | 600245   | F5   | 697066   | B3   | 704091   | M21  |
| 581040   | H4   | 591116   | E5   | 600246   | F5   | 697087   | B3   | 704093   | M21  |
| 581100   | H3   | 591161   | E4   | 600258   | F5   | 697097   | B3   | 704095   | M21  |
| 581100-5 | H3   | 593019   | E4   | 600259   | F3   | 697107   | B3   | 704120   | M122 |
| 581101   | H3   | 593022   | E4   | 600260   | F2   | 697112   | B3   | 704120   | M21  |
| 581101-5 | H3   | 593024   | E4   | 600263   | F3   | 697124   | B4   | 704121   | M21  |
| 581102   | H3   | 593029   | E4   | 600264   | F2   | 697125   | B4   | 704122   | M122 |
| 581102-5 | H3   | 593052   | E6   | 600265   | F5   | 697187   | B4   | 704122   | M21  |
| 581103   | H3   | 593054   | E6   | 600270   | F4   | 697197   | B4   | 704132-5 | M21  |
| 581103-5 | H3   | 593057   | E4   | 600631   | F5   | 697287   | B3   | 704152-5 | M21  |
| 581104   | H3   | 593060   | E4   | 600632   | F5   | 697297   | B3   | 704153-5 | M21  |
| 581104-5 | H3   | 593083   | E7   | 600633   | F5   | 699087   | B3   | 704154   | M21  |
| 581105   | H3   | 593084   | E7   | 601063   | F5   | 699097   | B3   | 704155   | M21  |
| 581105-5 | H3   | 593101   | E4   | 601065   | F2   | 699107   | B3   | 704158   | M21  |
| 581106   | H3   | 593106   | E7   | 601069   | F5   | 699112   | B3   | 704159   | M21  |
| 581106-5 | H3   | 593111   | E4   | 602002   | F8   | 699287   | B3   | 704177-5 | M21  |
| 581107   | H3   | 593116   | E4   | 690007   | R7   | 699297   | B3   | 704178-5 | M21  |
| 581107-5 | H3   | 593121   | E6   | 690008   | R7   | 700064   | M31  | 704268   | M20  |
| 590036   | E3   | 593123   | E4   | 690021   | H3   | 701001   | M31  | 704280   | M20  |
| 590046   | E3   | 593124   | E6   | 690022   | H3   | 701006   | M31  | 704315   | M21  |
| 590061   | E2   | 600007   | F4   | 690023   | H3   | 701050   | M31  | 704325   | M21  |
| 590080   | E3   | 600009   | F4   | 690031   | FH16 | 701054   | M31  | 704335   | M21  |
| 590081   | E3   | 600011   | F5   | 690033   | FH16 | 701071   | M31  | 705038   | M5   |
| 590135   | E2   | 600017   | F4   | 690035   | FH16 | 701072   | M31  | 705101   | M4   |
| 590136   | E2   | 600021   | F5   | 690037   | FH16 | 702023   | M20  | 705102   | M4   |
| 590154   | E3   | 600040   | F5   | 690050   | FH16 | 702023   | M21  | 705103   | M4   |
| 590155   | E3   | 600041   | F5   | 690059   | FH17 | 702042   | M3   | 705104   | M5   |
| 590156   | E3   | 600053   | F5   | 690064   | FH18 | 702044   | M3   | 705105   | M5   |
| 590157   | E3   | 600081   | F5   | 690071   | FH18 | 702045   | M3   | 705107   | M5   |
| 590159   | E3   | 600112   | F8   | 690072   | FH17 | 702047   | M3   | 705108   | M4   |
| 590160   | E3   | 600133   | F4   | 690090   | R6   | 702051   | M21  | 705111   | M5   |
| 590161   | E3   | 600135   | F2   | 690091   | R6   | 702057   | M21  | 705112   | M3   |
| 590163   | E3   | 600136   | F2   | 690104   | R9   | 702076   | M20  | 705113   | M3   |
| 590165   | E3   | 600148   | F2   | 690107   | R9   | 702076   | M21  | 705114   | M3   |
| 590166   | E3   | 600149   | F3   | 690108   | R9   | 702086   | M68  | 705115   | M3   |
| 590171   | E2   | 600150   | F3   | 690110   | R2   | 702098-5 | M20  | 705116   | M3   |
| 590172   | E2   | 600168   | F2   | 690111   | R4   | 702148   | M13  | 705117   | M5   |
| 590177   | E3   | 600169-6 | F3   | 690187   | R5   | 702149   | M13  | 705148   | M50  |
| 590178   | E3   | 600175   | F5   | 690188   | R5   | 702158   | M13  | 705150   | M50  |
| 590179   | E3   | 600176   | F5   | 690189   | R5   | 702159   | M13  | 705332   | M4   |
| 590180   | E3   | 600180   | F2   | 690190   | R5   | 703005   | M20  | 705333   | M4   |
| 590181   | E3   | 600181-6 | F3   | 690191   | R5   | 703005   | M21  | 705334   | M4   |
| 590182   | E3   | 600183-6 | F3   | 690192   | R5   | 703006   | M20  | 705335   | M4   |
| 590251   | E3   | 600184   | F2   | 690193   | R5   | 703007   | M20  | 708001   | M3   |
| 590252   | E3   | 600185-6 | F3   | 690194   | R5   | 703007   | M21  | 708005   | M3   |
| 590253   | E3   | 600186   | F2   | 690195   | R5   | 703008   | M20  | 708008   | M3   |
| 590254   | E3   | 600191   | F8   | 690196   | R5   | 703101   | M21  | 708020   | M3   |
| 590255   | E3   | 600196-6 | F4   | 690201   | R3   | 703102   | M21  | 708022   | M3   |
| 590256   | E3   | 600198   | F2   | 690202   | R6   | 703103   | M21  | 708046   | M3   |
| 590263   | E2   | 600211   | F2   | 691015   | E31  | 703104   | M21  | 708156   | M20  |
| 590264   | E2   | 600212   | F3   | 691015   | R9   | 704032   | M21  | 708176-5 | M20  |
| 591009   | E5   | 600219   | F5   | 691020   | R8   | 704065   | M129 | 708181   | M20  |
| 591010   | E5   | 600220   | F5   | 696087   | B4   | 704066   | M129 | 708197-5 | M20  |
| 591019   | E7   | 600221   | F5   | 696097   | B4   | 704068   | M129 | 708198-5 | M20  |
|          |      | 600241   | F5   | 696107   | B4   | 704069   | M129 | 708209   | M2   |



Call the Velvac Sales Team: **800.783.8871** [sales@velvac.com](mailto:sales@velvac.com)

| PART NO. | PAGE | PART NO. | PAGE | PART NO. | PAGE | PART NO. | PAGE | PART NO. | PAGE |
|----------|------|----------|------|----------|------|----------|------|----------|------|
| 708209-4 | M2   | 708609   | M13  | 710615   | V3   | 714526   | M46  | 714589   | M23  |
| 708210   | M2   | 708610   | M13  | 710640   | V11  | 714527   | M46  | 714590   | M126 |
| 708211   | M2   | 708611   | M19  | 710640-1 | V11  | 714528   | M46  | 714590   | M23  |
| 708211-4 | M2   | 708615   | M13  | 710640-3 | V11  | 714529   | M46  | 714591   | M61  |
| 708212   | M2   | 708685   | M50  | 710641   | V11  | 714530   | M46  | 714592   | M61  |
| 708212-4 | M2   | 709002   | M18  | 710649   | V11  | 714531   | M46  | 714593   | M61  |
| 708331   | M4   | 709006   | M18  | 710651   | V11  | 714532   | M46  | 714601   | M61  |
| 708335   | M93  | 709216   | M12  | 710651-1 | V11  | 714533   | M46  | 714602   | M61  |
| 708336   | M93  | 709217   | M12  | 710651-3 | V11  | 714534   | M46  | 714603   | M61  |
| 708337   | M93  | 709218   | M12  | 710723   | V6   | 714535   | M46  | 714604   | M61  |
| 708368   | M2   | 709226   | M12  | 712245   | M30  | 714536   | M46  | 714605   | M61  |
| 708369   | M2   | 709226   | M122 | 712323   | M30  | 714537   | M46  | 714606   | M61  |
| 708441   | M12  | 709275   | M18  | 712479   | M30  | 714538   | M46  | 714607   | M126 |
| 708442   | M12  | 709276   | M18  | 712638   | M29  | 714539   | M46  | 714607   | M23  |
| 708444   | M12  | 709309   | M2   | 712640   | M29  | 714540   | M46  | 714608   | M126 |
| 708446   | M12  | 709329   | M2   | 712641   | M29  | 714541   | M46  | 714608   | M23  |
| 708448   | M12  | 709407   | M126 | 712642   | M29  | 714542   | M46  | 714620   | M24  |
| 708449   | M12  | 709422   | M126 | 712643   | M29  | 714543   | M46  | 714621   | M24  |
| 708450   | M12  | 709448   | M126 | 712644   | M29  | 714544   | M46  | 714622   | M24  |
| 708453   | M12  | 709448   | M23  | 712647   | M29  | 714545   | M61  | 714623   | M24  |
| 708457   | M12  | 709449   | M126 | 712648   | M128 | 714546   | M61  | 714624   | M24  |
| 708463   | M12  | 709449   | M23  | 712896   | M122 | 714547   | M61  | 714625   | M24  |
| 708463   | M122 | 709450   | M23  | 712897   | M122 | 714548   | M61  | 714626   | M24  |
| 708473   | M12  | 709589   | M126 | 712898   | M122 | 714549   | M61  | 714627   | M24  |
| 708476   | M12  | 709589   | M23  | 712900   | M122 | 714550   | M61  | 714628   | M24  |
| 708478   | M12  | 709623   | M23  | 712979   | M130 | 714551   | M61  | 714629   | M24  |
| 708479   | M12  | 709624   | M23  | 713118   | M49  | 714552   | M61  | 714630   | M24  |
| 708501   | M12  | 709650   | M23  | 713119   | M49  | 714553   | M61  | 714631   | M24  |
| 708502   | M12  | 709651   | M23  | 713120   | M49  | 714554   | M61  | 714646   | M24  |
| 708503   | M12  | 709673   | M126 | 713121   | M49  | 714555   | M61  | 714647   | M24  |
| 708504   | M12  | 709673   | M23  | 713154   | M49  | 714556   | M61  | 714648   | M24  |
| 708508   | M12  | 709674   | M126 | 713198   | M93  | 714557   | M61  | 714649   | M24  |
| 708509   | M12  | 709674   | M23  | 713204   | M49  | 714558   | M61  | 714720   | M25  |
| 708510   | M12  | 709701   | M23  | 713404   | M30  | 714559   | M61  | 714721   | M25  |
| 708511   | M12  | 709702   | M23  | 713444   | M25  | 714560   | M61  | 714782   | M122 |
| 708513   | M12  | 709732   | M23  | 713445   | M25  | 714561   | M61  | 714783   | M122 |
| 708514   | M12  | 709733   | M23  | 713752   | M29  | 714562   | M61  | 714784   | M122 |
| 708515   | M12  | 709748   | M126 | 713759   | M31  | 714563   | M61  | 714785   | M122 |
| 708516   | M12  | 709785   | M127 | 713760   | M31  | 714564   | M61  | 714904   | M61  |
| 708520   | M12  | 709855   | M126 | 713769   | M31  | 714565   | M61  | 714905   | M61  |
| 708521   | M12  | 709915   | V6   | 713796   | M67  | 714566   | M61  | 714906   | M61  |
| 708525   | M4   | 709921   | V10  | 713798   | M67  | 714567   | M61  | 714907   | M61  |
| 708526   | M4   | 709931   | M126 | 713883   | M67  | 714568   | M61  | 714908   | M61  |
| 708551   | M12  | 709932   | M126 | 713993   | M67  | 714569   | M61  | 714909   | M61  |
| 708552   | M12  | 709941   | V5   | 714146   | M122 | 714570   | M61  | 714910   | M61  |
| 708553   | M12  | 709942   | V5   | 714147   | M122 | 714571   | M61  | 714911   | M61  |
| 708554   | M12  | 709948   | V5   | 714256   | M126 | 714572   | M61  | 714912   | M61  |
| 708555   | M12  | 709949   | V5   | 714258   | M126 | 714573   | M61  | 714913   | M61  |
| 708556   | M12  | 709954   | V10  | 714403   | M28  | 714574   | M61  | 714914   | M61  |
| 708557   | M12  | 709993   | M127 | 714515   | M46  | 714575   | M126 | 714915   | M61  |
| 708558   | M12  | 709994   | M126 | 714516   | M46  | 714576   | M126 | 714916   | M61  |
| 708559   | M12  | 709995   | M126 | 714517   | M46  | 714577   | M126 | 714917   | M61  |
| 708560   | M12  | 710323   | V6   | 714518   | M46  | 714578   | M126 | 714918   | M61  |
| 708601   | M13  | 710324   | V6   | 714519   | M46  | 714579   | M126 | 714919   | M61  |
| 708602   | M13  | 710325   | V5   | 714520   | M46  | 714580   | M126 | 714920   | M61  |
| 708603   | M13  | 710326   | V3   | 714521   | M46  | 714581   | M126 | 714921   | M61  |
| 708604   | M13  | 710521   | V3   | 714522   | M46  | 714581   | M23  | 714942   | M23  |
| 708605   | M13  | 710522   | V3   | 714523   | M46  | 714582   | M126 | 714943   | M23  |
| 708606   | M13  | 710523   | V3   | 714524   | M46  | 714582   | M23  | 714944   | M23  |
| 708608   | M13  | 710589   | V5   | 714525   | M46  | 714589   | M126 | 714945   | M23  |

## PARTS INDEX

| PART NO. | PAGE | PART NO. | PAGE | PART NO. | PAGE | PART NO. | PAGE | PART NO. | PAGE |
|----------|------|----------|------|----------|------|----------|------|----------|------|
| 714946   | M23  | 715438   | M39  | 715920   | M63  | 716107   | M127 | 716358   | M42  |
| 714947   | M23  | 715439   | M39  | 715921   | M63  | 716109   | M127 | 716359   | M42  |
| 715101   | M29  | 715440   | M39  | 715922   | M63  | 716113   | M127 | 716360   | M42  |
| 715131   | M46  | 715441   | M39  | 715923   | M41  | 716115   | M127 | 716361   | M42  |
| 715132   | M46  | 715442   | M39  | 715924   | M41  | 716138-5 | M67  | 716362   | M42  |
| 715133   | M46  | 715443   | M39  | 715925   | M41  | 716152   | M23  | 716363   | M42  |
| 715141   | M46  | 715444   | M39  | 715926   | M41  | 716153   | M23  | 716364   | M42  |
| 715148   | M25  | 715445   | M39  | 715927   | M41  | 716154   | M23  | 716365   | M42  |
| 715150   | M25  | 715446   | M39  | 715928   | M41  | 716155   | M23  | 716366   | M42  |
| 715153   | M46  | 715447   | M39  | 715929   | M41  | 716187   | M23  | 716367   | M41  |
| 715154   | M46  | 715448   | M39  | 715930   | M41  | 716188   | M23  | 716368   | M41  |
| 715166   | M51  | 715449   | M39  | 715931   | M41  | 716189   | M23  | 716369   | M41  |
| 715168   | M51  | 715450   | M39  | 715932   | M41  | 716190   | M23  | 716370   | M41  |
| 715198   | M18  | 715451   | M39  | 715933   | M41  | 716205   | M23  | 716371   | M41  |
| 715203   | M18  | 715452   | M39  | 715934   | M41  | 716206   | M23  | 716372   | M41  |
| 715212   | M28  | 715453   | M39  | 715935   | M63  | 716207   | M23  | 716373   | M63  |
| 715213   | M28  | 715454   | M39  | 715936   | M63  | 716208   | M23  | 716374   | M63  |
| 715372   | M22  | 715455   | M39  | 715937   | M63  | 716314   | V6   | 716375   | M63  |
| 715373   | M22  | 715456   | M39  | 715938   | M63  | 716318   | V6   | 716376   | M63  |
| 715374   | M22  | 715457   | M39  | 715939   | M63  | 716319   | M41  | 716377   | M63  |
| 715401   | M39  | 715458   | M39  | 715940   | M63  | 716320   | M41  | 716378   | M63  |
| 715402   | M39  | 715459   | M39  | 715941   | M63  | 716321   | M41  | 716379   | M41  |
| 715403   | M39  | 715460   | M39  | 715942   | M63  | 716322   | M41  | 716380   | M41  |
| 715404   | M39  | 715529   | M24  | 715943   | M63  | 716323   | M41  | 716381   | M41  |
| 715405   | M39  | 715620   | M24  | 715944   | M63  | 716324   | M41  | 716382   | M41  |
| 715406   | M39  | 715704   | M119 | 715945   | M63  | 716325   | M63  | 716383   | M41  |
| 715407   | M39  | 715778   | M25  | 715946   | M63  | 716326   | M63  | 716384   | M41  |
| 715408   | M39  | 715779   | M25  | 715953   | M41  | 716327   | M63  | 716385   | M63  |
| 715409   | M39  | 715786   | M122 | 715954   | M41  | 716328   | M63  | 716386   | M63  |
| 715410   | M39  | 715859   | M46  | 715955   | M41  | 716329   | M63  | 716387   | M63  |
| 715411   | M39  | 715860   | M46  | 715962   | M63  | 716330   | M63  | 716388   | M63  |
| 715412   | M39  | 715861   | M46  | 715963   | M63  | 716331   | M42  | 716389   | M63  |
| 715413   | M39  | 715885   | M68  | 715964   | M63  | 716332   | M42  | 716390   | M63  |
| 715414   | M39  | 715886   | M68  | 715971   | M41  | 716333   | M42  | 716391   | M41  |
| 715415   | M39  | 715887   | M68  | 715972   | M41  | 716334   | M42  | 716392   | M41  |
| 715416   | M39  | 715888   | M68  | 715973   | M41  | 716335   | M42  | 716393   | M41  |
| 715417   | M39  | 715889   | M68  | 715980   | M63  | 716336   | M42  | 716394   | M41  |
| 715418   | M39  | 715899   | M41  | 715981   | M63  | 716337   | M42  | 716395   | M41  |
| 715419   | M39  | 715900   | M41  | 715982   | M63  | 716338   | M42  | 716396   | M41  |
| 715420   | M39  | 715901   | M41  | 715985   | M126 | 716339   | M42  | 716397   | M63  |
| 715421   | M39  | 715902   | M41  | 715986   | M126 | 716340   | M42  | 716398   | M63  |
| 715422   | M39  | 715903   | M41  | 715987   | M126 | 716341   | M42  | 716399   | M63  |
| 715423   | M39  | 715904   | M41  | 715988   | M126 | 716342   | M42  | 716402   | M42  |
| 715424   | M39  | 715905   | M41  | 715989   | M126 | 716343   | M41  | 716403   | M42  |
| 715425   | M39  | 715906   | M41  | 715990   | M126 | 716344   | M41  | 716404   | M42  |
| 715426   | M39  | 715907   | M41  | 715991   | M126 | 716345   | M41  | 716405   | M42  |
| 715427   | M39  | 715908   | M41  | 715992   | M126 | 716346   | M41  | 716406   | M42  |
| 715428   | M39  | 715909   | M41  | 715997   | M126 | 716347   | M41  | 716407   | M42  |
| 715429   | M39  | 715910   | M41  | 716011   | M126 | 716348   | M41  | 716408   | M42  |
| 715430   | M39  | 715911   | M63  | 716011   | M127 | 716349   | M63  | 716409   | M42  |
| 715431   | M39  | 715912   | M63  | 716012   | M126 | 716350   | M63  | 716410   | M42  |
| 715432   | M39  | 715913   | M63  | 716012   | M127 | 716351   | M63  | 716411   | M41  |
| 715433   | M39  | 715914   | M63  | 716055   | M127 | 716352   | M63  | 716412   | M41  |
| 715434   | M39  | 715915   | M63  | 716056   | M127 | 716353   | M63  | 716413   | M41  |
| 715435   | M39  | 715916   | M63  | 716103   | M126 | 716354   | M63  | 716414   | M41  |
| 715436   | M39  | 715917   | M63  | 716104   | M126 | 716355   | M42  | 716415   | M41  |
| 715437   | M39  | 715918   | M63  | 716105   | M126 | 716356   | M42  | 716416   | M41  |
|          |      | 715919   | M63  | 716106   | M126 | 716357   | M42  | 716417   | M63  |



Call the Velvac Sales Team: **800.783.8871** [sales@velvac.com](mailto:sales@velvac.com)

| PART NO. | PAGE | PART NO. | PAGE | PART NO. | PAGE | PART NO. | PAGE | PART NO. | PAGE |
|----------|------|----------|------|----------|------|----------|------|----------|------|
| 716418   | M63  | 717181   | M45  | 717577   | M65  | 717870   | V4   | 718525   | M66  |
| 716419   | M63  | 717182   | M45  | 717578   | M65  | 717871   | V5   | 718526   | M66  |
| 716420   | M63  | 717183   | M45  | 717579   | M65  | 717878   | V4   | 718527   | M66  |
| 716421   | M63  | 717184   | M45  | 717580   | M65  | 717897   | V4   | 718534   | M66  |
| 716422   | M63  | 717185   | M45  | 717581   | M65  | 717901   | V4   | 718535   | M66  |
| 716423   | M42  | 717186   | M45  | 717582   | M65  | 717953   | V4   | 718536   | M66  |
| 716424   | M42  | 717187   | M45  | 717583   | M65  | 717971   | V4   | 718555   | M66  |
| 716425   | M42  | 717188   | M45  | 717584   | M65  | 717973   | V3   | 718556   | M66  |
| 716426   | M42  | 717189   | M45  | 717585   | M65  | 717991   | V4   | 718557   | M66  |
| 716427   | M42  | 717379   | M45  | 717586   | M44  | 717992   | V4   | 718561   | M66  |
| 716428   | M42  | 717380   | M45  | 717587   | M44  | 717993   | V4   | 718562   | M66  |
| 716429   | M42  | 717381   | M45  | 717588   | M44  | 717993-5 | V4   | 718563   | M66  |
| 716430   | M42  | 717382   | M45  | 717589   | M44  | 717994   | V4   | 718573   | M66  |
| 716431   | M42  | 717383   | M45  | 717590   | M44  | 717994-5 | V4   | 718574   | M66  |
| 716433   | M126 | 717384   | M45  | 717591   | M44  | 718389-5 | M61  | 718575   | M66  |
| 716434   | M126 | 717501   | M45  | 717592   | M44  | 718390-5 | M61  | 718612   | M43  |
| 716435   | M63  | 717502   | M45  | 717593   | M44  | 718391-5 | M61  | 718613   | M43  |
| 716436   | M63  | 717503   | M45  | 717594   | M44  | 718394-5 | M18  | 718614   | M43  |
| 716437   | M63  | 717504   | M43  | 717595   | M44  | 718416   | M64  | 718615   | M43  |
| 716498   | M126 | 717505   | M43  | 717596   | M44  | 718417   | M64  | 718616   | M43  |
| 716499   | M126 | 717506   | M43  | 717597   | M44  | 718418   | M64  | 718617   | M43  |
| 716502   | M126 | 717507   | M43  | 717598   | M44  | 718419   | M64  | 718618   | M65  |
| 716503   | M126 | 717508   | M43  | 717599   | M44  | 718420   | M64  | 718619   | M65  |
| 716504   | M126 | 717509   | M43  | 717600   | M44  | 718421   | M64  | 718620   | M65  |
| 716505   | M126 | 717513   | M45  | 717601   | M44  | 718422   | M64  | 718621   | M65  |
| 716506   | M126 | 717514   | M45  | 717602   | M44  | 718423   | M64  | 718622   | M65  |
| 716507   | M126 | 717515   | M45  | 717603   | M44  | 718424   | M64  | 718623   | M65  |
| 716508   | M126 | 717516   | M43  | 717607   | M44  | 718425   | M64  | 718754   | M66  |
| 716509   | M126 | 717517   | M43  | 717608   | M44  | 718426   | M64  | 718755   | M66  |
| 716515   | M127 | 717518   | M43  | 717609   | M44  | 718427   | M64  | 718756   | M66  |
| 716516   | M127 | 717523   | M43  | 717809   | V13  | 718428   | M64  | 718757   | M66  |
| 716519   | M127 | 717524   | M43  | 717810   | V13  | 718429   | M64  | 718758   | M66  |
| 716520   | M127 | 717525   | M43  | 717811   | V13  | 718430   | M64  | 718759   | M66  |
| 716521   | M127 | 717526   | M43  | 717812   | V13  | 718431   | M64  | 718763   | M66  |
| 716522   | M127 | 717527   | M43  | 717813   | V13  | 718432   | M64  | 718764   | M66  |
| 716525   | M127 | 717528   | M43  | 717814   | V13  | 718433   | M64  | 718765   | M66  |
| 716526   | M127 | 717541   | M43  | 717815   | V13  | 718434   | M64  | 718766   | M66  |
| 716872   | M18  | 717542   | M43  | 717816   | V13  | 718435   | M64  | 718767   | M66  |
| 716900   | M28  | 717543   | M43  | 717817   | V13  | 718436   | M64  | 718768   | M66  |
| 716901   | M28  | 717544   | M43  | 717818   | V13  | 718437   | M64  | 719263   | M129 |
| 716902   | M119 | 717545   | M43  | 717819   | V13  | 718438   | M64  | 719267   | M50  |
| 716902   | M29  | 717546   | M43  | 717820   | V13  | 718439   | M64  | 719268   | M50  |
| 716903   | M29  | 717547   | M43  | 717821   | V13  | 718440   | M64  | 719274   | M126 |
| 716906   | M29  | 717548   | M43  | 717822   | V13  | 718441   | M64  | 719275   | M126 |
| 716907   | M29  | 717549   | M43  | 717823   | V13  | 718442   | M64  | 719276   | M126 |
| 716908   | M49  | 717550   | M65  | 717824   | V13  | 718443   | M64  | 719277   | M126 |
| 716909   | M67  | 717551   | M65  | 717825   | V13  | 718444   | M64  | 719295   | M66  |
| 716913   | M24  | 717552   | M65  | 717826   | V13  | 718445   | M64  | 719296   | M66  |
| 716914   | M24  | 717553   | M65  | 717827   | V13  | 718446   | M64  | 719297   | M66  |
| 716915   | M24  | 717554   | M65  | 717828   | V13  | 718447   | M64  | 719301-7 | M66  |
| 716916   | M24  | 717555   | M65  | 717829   | V13  | 718448   | M64  | 719302   | M66  |
| 716917   | M24  | 717556   | M65  | 717830   | V13  | 718449   | M64  | 719303   | M66  |
| 716918   | M24  | 717557   | M65  | 717831   | V13  | 718450   | M64  | 719305   | M47  |
| 716919   | M24  | 717558   | M65  | 717832   | V13  | 718451   | M64  | 719306   | M47  |
| 716922   | M24  | 717559   | M65  | 717844   | M25  | 718513   | M66  | 719307   | M47  |
| 716973   | M126 | 717560   | M65  | 717845   | M25  | 718514   | M66  | 719311   | M40  |
| 716974   | M126 | 717561   | M65  | 717866   | M44  | 718515   | M66  | 719312   | M40  |
| 717174   | M45  | 717574   | M65  | 717867   | M44  | 718519   | M66  | 719313   | M40  |
| 717175   | M45  | 717575   | M65  | 717868   | M44  | 718520   | M66  | 719314   | M40  |
| 717176   | M45  | 717576   | M65  | 717869   | V4   | 718521   | M66  | 719315   | M40  |

## PARTS INDEX

| PART NO. | PAGE | PART NO. | PAGE | PART NO. | PAGE | PART NO. | PAGE | PART NO. | PAGE |
|----------|------|----------|------|----------|------|----------|------|----------|------|
| 719316   | M40  | 719374   | M40  | 719434   | M62  | 719600   | V8   | 724007   | M30  |
| 719317   | M40  | 719375   | M40  | 719435   | M62  | 719601   | V8   | 724008   | M30  |
| 719318   | M40  | 719376   | M40  | 719436   | M62  | 719602   | V8   | 727067   | M30  |
| 719319   | M40  | 719379   | M40  | 719437   | M62  | 719603   | V8   | 728513   | M47  |
| 719320   | M40  | 719380   | M40  | 719438   | M62  | 719612   | V9   | 728514   | M47  |
| 719321   | M40  | 719381   | M40  | 719439   | M62  | 719632   | V13  | 728515   | M47  |
| 719322   | M40  | 719382   | M40  | 719440   | M62  | 719633   | V13  | 728519   | M47  |
| 719323   | M40  | 719383   | M40  | 719441   | M62  | 719634   | V13  | 728520   | M47  |
| 719324   | M40  | 719384   | M40  | 719442   | M62  | 719635   | V13  | 728521   | M47  |
| 719325   | M40  | 719385   | M40  | 719443   | M62  | 719636   | V13  | 728525   | M47  |
| 719326   | M40  | 719386   | M40  | 719444   | M62  | 719637   | V13  | 728526   | M47  |
| 719327   | M40  | 719387   | M40  | 719445   | M62  | 719748   | M45  | 728527   | M47  |
| 719328   | M40  | 719388   | M40  | 719446   | M62  | 719749   | M45  | 728534   | M47  |
| 719329   | M40  | 719389   | M40  | 719447   | M62  | 719750   | M45  | 728535   | M47  |
| 719330   | M40  | 719390   | M40  | 719448   | M62  | 719751   | M45  | 728536   | M47  |
| 719331   | M40  | 719391   | M40  | 719449   | M62  | 719752   | M45  | 728555   | M47  |
| 719332   | M40  | 719392   | M40  | 719450   | M62  | 719753   | M45  | 728556   | M47  |
| 719333   | M40  | 719393   | M40  | 719451   | M62  | 719754   | M45  | 728557   | M47  |
| 719334   | M40  | 719394   | M40  | 719452   | M62  | 719755   | M45  | 728561   | M47  |
| 719335   | M40  | 719395   | M40  | 719453   | M62  | 719756   | M45  | 728562   | M47  |
| 719336   | M40  | 719396   | M40  | 719454   | M62  | 719757   | M45  | 728563   | M47  |
| 719337   | M40  | 719397   | M62  | 719455   | M62  | 719758   | M45  | 728573   | M47  |
| 719338   | M40  | 719398   | M62  | 719456   | M62  | 719759   | M45  | 728574   | M47  |
| 719339   | M40  | 719399   | M62  | 719457   | M62  | 719760   | M45  | 728575   | M47  |
| 719340   | M40  | 719400   | M62  | 719458   | M62  | 719761   | M45  | 728754   | M47  |
| 719341   | M40  | 719401   | M62  | 719459   | M62  | 719762   | M45  | 728755   | M47  |
| 719342   | M40  | 719402   | M62  | 719460   | M62  | 720300   | M27  | 728756   | M47  |
| 719343   | M40  | 719403   | M62  | 719461   | M62  | 720301   | M27  | 728757   | M47  |
| 719344   | M40  | 719404   | M62  | 719462   | M62  | 720302   | M27  | 728758   | M47  |
| 719345   | M40  | 719405   | M62  | 719463   | M62  | 720303   | M27  | 728759   | M47  |
| 719346   | M40  | 719406   | M62  | 719464   | M62  | 720304   | M27  | 728766   | M47  |
| 719347   | M40  | 719407   | M62  | 719465   | M62  | 720305   | M27  | 728767   | M47  |
| 719348   | M40  | 719408   | M62  | 719466   | M62  | 720306   | M27  | 728768   | M47  |
| 719349   | M40  | 719409   | M62  | 719467   | M62  | 720308   | M27  | 728778   | M47  |
| 719350   | M40  | 719410   | M62  | 719468   | M62  | 720310   | M27  | 728779   | M47  |
| 719351   | M40  | 719411   | M62  | 719469   | M62  | 721090   | M30  | 728780   | M47  |
| 719352   | M40  | 719412   | M62  | 719470   | M62  | 721092   | M30  | 745137   | V7   |
| 719353   | M40  | 719413   | M62  | 719471   | M62  | 723047   | M128 | 745138   | V7   |
| 719354   | M40  | 719414   | M62  | 719472   | M62  | 723049   | M128 | 745142   | V7   |
| 719355   | M40  | 719415   | M62  | 719473   | M62  | 723050   | M19  | 745241   | V11  |
| 719356   | M40  | 719416   | M62  | 719474   | M62  | 723055   | M128 | 745243   | V7   |
| 719357   | M40  | 719417   | M62  | 719475   | M62  | 723057   | M128 | 745244   | V7   |
| 719358   | M40  | 719418   | M62  | 719476   | M62  | 723060   | M19  | 745245   | V7   |
| 719360   | M40  | 719419   | M62  | 719477   | M62  | 723065   | M19  | 745252   | V7   |
| 719361   | M40  | 719420   | M62  | 719478   | M62  | 723068   | M122 | 747053   | M130 |
| 719362   | M40  | 719421   | M62  | 719479   | M62  | 723068   | M19  | 747070   | M128 |
| 719363   | M40  | 719422   | M62  | 719480   | M62  | 723068-6 | M19  | 747072   | M128 |
| 719364   | M40  | 719423   | M62  | 719515   | M47  | 723075   | M19  | 747386   | M2   |
| 719365   | M40  | 719424   | M62  | 719516   | M47  | 723091   | M130 | 747387   | M2   |
| 719366   | M40  | 719425   | M62  | 719517   | M47  | 723095   | M18  | 747451   | M2   |
| 719367   | M40  | 719426   | M62  | 719592   | V9   | 723097   | M18  | 747524   | M127 |
| 719368   | M40  | 719427   | M62  | 719593   | V9   | 723100   | M128 | 747551   | M127 |
| 719369   | M40  | 719428   | M62  | 719594   | V9   | 723103   | M122 | 747632   | M127 |
| 719370   | M40  | 719429   | M62  | 719595   | V10  | 723103   | M13  | 747633   | M127 |
| 719371   | M40  | 719430   | M62  | 719596   | V10  | 723104   | M13  | 747850   | V7   |
| 719372   | M40  | 719431   | M62  | 719597   | V10  | 723106   | M68  | 747855   | M127 |
| 719373   | M40  | 719432   | M62  | 719598   | V8   | 723107   | M68  | 747856   | M127 |
|          |      | 719433   | M62  | 719599   | V8   | 723115   | M128 | 747863   | M127 |



Call the Velvac Sales Team: **800.783.8871** [sales@velvac.com](mailto:sales@velvac.com)



| PART NO.   | PAGE | PART NO.    | PAGE | PART NO.   | PAGE | PART NO.   | PAGE | PART NO.   | PAGE |
|------------|------|-------------|------|------------|------|------------|------|------------|------|
| 747864     | V7   | V084200101  | M84  | V134281011 | M118 | V154003117 | M98  | V154280003 | M73  |
| 747865     | V7   | V084270006  | M107 | V134281011 | M17  | V154003117 | M77  | V154382117 | M6   |
| 747866     | V7   | V084270006  | M116 | V134281011 | M36  | V154003117 | M83  | V154382117 | M81  |
| 747867     | V7   | V084270006  | M118 | V134281011 | M69  | V154003117 | M89  | V154382117 | M85  |
| 747894     | V7   | V084270006  | M121 | V134281011 | M80  | V154004001 | M98  | V154580003 | M14  |
| 747901     | M127 | V084270006  | M34  | V134281011 | M92  | V154004001 | M77  | V404055700 | M75  |
| 748009     | M130 | V084270006  | M36  | V134281015 | M101 | V154004001 | M83  | V404055700 | M87  |
| 748012     | M130 | V084270006  | M71  | V134281015 | M102 | V154004001 | M89  | V404055700 | M95  |
| 748029     | M129 | V084270006  | M73  | V134281015 | M107 | V154004002 | M98  | V404055800 | M75  |
| 748215     | M128 | V084270006  | M9   | V134281015 | M112 | V154004002 | M77  | V404055800 | M87  |
| 748216     | M30  | V084380005  | M81  | V134281015 | M116 | V154004002 | M83  | V404055800 | M95  |
| 748269     | M128 | V084803997  | M10  | V134281015 | M118 | V154004002 | M89  | V404065204 | M75  |
| 748304     | M127 | V084803997  | M103 | V134281015 | M121 | V154148001 | M55  | V404065204 | M87  |
| 748355     | M130 | V084803997  | M108 | V134281015 | M17  | V154148001 | M56  | V404065204 | M95  |
| 748377     | M130 | V093841100  | M52  | V134281015 | M34  | V154148001 | M57  | V404065304 | M75  |
| 748416     | M129 | V094002590  | M98  | V134281015 | M36  | V154148002 | M55  | V404065304 | M87  |
| 757015     | M129 | V094002590  | M77  | V134281015 | M69  | V154148002 | M56  | V404065304 | M95  |
| 757016     | M129 | V094002590  | M83  | V134281015 | M73  | V154148002 | M57  | V514080002 | M48  |
| 790563     | V7   | V094002590  | M89  | V134281015 | M80  | V154148002 | M58  | V514080002 | M96  |
| 790564     | V7   | V094252591  | M98  | V134281015 | M92  | V154158001 | M55  | V514090028 | M104 |
| 790576     | V7   | V094252591  | M77  | V134580001 | M14  | V154158001 | M56  | V514090028 | M109 |
| 790605     | V7   | V094252591  | M83  | V144580001 | M14  | V154158001 | M57  | V514090028 | M113 |
| V083200233 | M105 | V094252591  | M89  | V153832000 | M7   | V154158001 | M58  | V514090029 | M104 |
| V083200233 | M107 | V113870510B | M105 | V153832003 | M53  | V154158002 | M55  | V514090029 | M109 |
| V083200233 | M114 | V113870510B | M110 | V153832003 | M7   | V154158002 | M56  | V514090029 | M113 |
| V083200233 | M116 | V113870510B | M114 | V153832107 | M104 | V154158002 | M57  | V514270001 | M70  |
| V083200233 | M118 | V113870510B | M16  | V153832107 | M109 | V154158002 | M58  | V514270001 | M8   |
| V083200233 | M33  | V114272001  | M107 | V153832107 | M113 | V154270010 | M121 | V514270002 | M70  |
| V083200233 | M73  | V114272001  | M112 | V153832107 | M53  | V154270010 | M71  | V514270002 | M8   |
| V083840200 | M52  | V114272001  | M116 | V153832107 | M7   | V154270010 | M9   | V514270003 | M70  |
| V083841300 | M125 | V114272001  | M118 | V153882117 | M105 | V154270011 | M106 | V514270003 | M8   |
| V083841400 | M125 | V114272001  | M121 | V153882117 | M110 | V154270011 | M111 | V514270004 | M70  |
| V084000100 | M98  | V114272001  | M33  | V153882117 | M114 | V154270011 | M115 | V514270004 | M8   |
| V084000100 | M77  | V114272001  | M70  | V153882117 | M15  | V154270011 | M118 | V514270013 | M70  |
| V084002002 | M98  | V114272001  | M8   | V153882117 | M16  | V154270011 | M121 | V514270013 | M8   |
| V084002002 | M77  | V134271000  | M118 | V153882117 | M54  | V154270011 | M33  | V514270014 | M70  |
| V084010001 | M125 | V134271000  | M36  | V153882117 | M81  | V154270011 | M35  | V514270014 | M8   |
| V084010001 | M57  | V134271000  | M71  | V153882120 | M101 | V154270011 | M71  | V514270015 | M106 |
| V084022051 | M110 | V134271000  | M9   | V153882120 | M102 | V154270011 | M72  | V514270015 | M111 |
| V084022051 | M112 | V134271001  | M71  | V153882120 | M16  | V154270011 | M9   | V514270015 | M115 |
| V084090001 | M105 | V134271001  | M9   | V153882120 | M54  | V154280001 | M101 | V514270015 | M117 |
| V084090001 | M110 | V134271008  | M107 | V153882120 | M80  | V154280001 | M102 | V514270015 | M120 |
| V084090001 | M114 | V134271008  | M112 | V153882120 | M92  | V154280001 | M121 | V514270015 | M35  |
| V084090001 | M54  | V134271008  | M116 | V153882210 | M16  | V154280001 | M17  | V514270015 | M72  |
| V084090001 | M7   | V134271008  | M118 | V153882210 | M54  | V154280001 | M69  | V514270015 | M8   |
| V084090002 | M105 | V134271008  | M121 | V153882213 | M15  | V154280001 | M80  | V514270016 | M106 |
| V084090002 | M110 | V134271008  | M36  | V153882213 | M16  | V154280001 | M92  | V514270016 | M111 |
| V084090002 | M114 | V134271008  | M71  | V153882213 | M54  | V154280002 | M107 | V514270016 | M115 |
| V084090002 | M54  | V134271008  | M72  | V154003100 | M98  | V154280002 | M112 | V514270016 | M117 |
| V084090002 | M7   | V134271008  | M9   | V154003100 | M77  | V154280002 | M116 | V514270016 | M120 |
| V084142400 | M125 | V134271009  | M107 | V154003100 | M83  | V154280002 | M118 | V514270016 | M35  |
| V084142400 | M57  | V134271009  | M112 | V154003100 | M89  | V154280002 | M17  | V514270016 | M72  |
| V084143012 | M55  | V134271009  | M116 | V154003107 | M98  | V154280002 | M36  | V514270016 | M8   |
| V084143012 | M56  | V134271009  | M118 | V154003107 | M77  | V154280002 | M73  | V514270017 | M106 |
| V084143012 | M57  | V134271009  | M121 | V154003107 | M83  | V154280003 | M107 | V514270017 | M111 |
| V084143012 | M58  | V134271009  | M34  | V154003107 | M89  | V154280003 | M116 | V514270017 | M115 |
| V084143112 | M55  | V134271009  | M71  | V154003110 | M98  | V154280003 | M118 | V514270017 | M117 |
| V084143112 | M56  | V134271009  | M9   | V154003110 | M77  | V154280003 | M121 | V514270017 | M120 |
| V084143112 | M57  | V134281011  | M101 | V154003110 | M83  | V154280003 | M17  | V514270017 | M33  |
| V084143112 | M58  | V134281011  | M102 | V154003110 | M89  | V154280003 | M34  | V514270017 | M8   |

## PARTS INDEX

| PART NO.   | PAGE | PART NO.   | PAGE | PART NO.   | PAGE | PART NO.   | PAGE | PART NO.   | PAGE |
|------------|------|------------|------|------------|------|------------|------|------------|------|
| V514270018 | M106 | V563600160 | M79  | V564281015 | M107 | V584004034 | M94  | V584004530 | M82  |
| V514270018 | M111 | V563600160 | M83  | V564281015 | M116 | V584004046 | M74  | V584004530 | M88  |
| V514270018 | M115 | V563600160 | M87  | V564281015 | M118 | V584004046 | M86  | V584004530 | M97  |
| V514270018 | M117 | V563600160 | M89  | V564281015 | M121 | V584004046 | M94  | V584004532 | M76  |
| V514270018 | M120 | V563600160 | M91  | V564281015 | M17  | V584004048 | M74  | V584004532 | M82  |
| V514270018 | M33  | V563600160 | M95  | V564281015 | M34  | V584004048 | M86  | V584004532 | M88  |
| V514270018 | M8   | V563600160 | M75  | V564281015 | M73  | V584004048 | M94  | V584004532 | M97  |
| V514270019 | M120 | V563600260 | M98  | V564450350 | M28  | V584004501 | M76  | V584004535 | M98  |
| V514270019 | M8   | V563600260 | M100 | V564450350 | M60  | V584004501 | M97  | V584004535 | M77  |
| V514270103 | M70  | V563600260 | M77  | V564451101 | M85  | V584004502 | M76  | V584004536 | M98  |
| V514270103 | M8   | V563600260 | M79  | V584004001 | M74  | V584004502 | M97  | V584004536 | M77  |
| V514270104 | M70  | V563600260 | M81  | V584004001 | M86  | V584004504 | M76  | V584004624 | M82  |
| V514270104 | M8   | V563600260 | M83  | V584004001 | M94  | V584004504 | M97  | V584004624 | M88  |
| V514270121 | M117 | V563600260 | M87  | V584004001 | M96  | V584004505 | M76  | V584004630 | M82  |
| V514270121 | M35  | V563600260 | M89  | V584004002 | M74  | V584004505 | M97  | V584004630 | M88  |
| V514270121 | M8   | V563600260 | M91  | V584004002 | M86  | V584004506 | M76  | V584005009 | M74  |
| V514270122 | M117 | V563600260 | M95  | V584004002 | M94  | V584004506 | M97  | V584005009 | M86  |
| V514270122 | M35  | V563600260 | M75  | V584004002 | M96  | V584004509 | M76  | V584005009 | M94  |
| V514270122 | M8   | V563882208 | M101 | V584004004 | M74  | V584004509 | M97  | V584005010 | M74  |
| V514271005 | M70  | V563882208 | M102 | V584004004 | M86  | V584004513 | M76  | V584005010 | M86  |
| V514271005 | M8   | V563882208 | M15  | V584004004 | M94  | V584004513 | M97  | V584005010 | M94  |
| V514271006 | M70  | V563882208 | M80  | V584004005 | M74  | V584004517 | M76  | V584005012 | M74  |
| V514271006 | M8   | V563882208 | M92  | V584004005 | M86  | V584004517 | M82  | V584005012 | M86  |
| V514271007 | M70  | V563882218 | M15  | V584004005 | M94  | V584004517 | M88  | V584005012 | M94  |
| V514271007 | M8   | V563882218 | M81  | V584004006 | M74  | V584004517 | M97  | V584005013 | M74  |
| V514271008 | M70  | V564080002 | M48  | V584004006 | M86  | V584004518 | M76  | V584005013 | M86  |
| V514271008 | M8   | V564080002 | M96  | V584004006 | M94  | V584004518 | M82  | V584005013 | M94  |
| V514271107 | M70  | V564090013 | M101 | V584004021 | M82  | V584004518 | M88  | V584005014 | M74  |
| V514271107 | M8   | V564090013 | M102 | V584004021 | M88  | V584004518 | M97  | V584005014 | M86  |
| V514271108 | M70  | V564090013 | M80  | V584004025 | M76  | V584004520 | M76  | V584005014 | M94  |
| V514271108 | M8   | V564090013 | M92  | V584004025 | M82  | V584004520 | M82  | V584005016 | M74  |
| V514380001 | M6   | V564090025 | M105 | V584004025 | M88  | V584004520 | M88  | V584005016 | M86  |
| V514380003 | M6   | V564090025 | M110 | V584004025 | M97  | V584004520 | M97  | V584005016 | M94  |
| V514380004 | M6   | V564090025 | M114 | V584004026 | M76  | V584004521 | M76  | V584049001 | M92  |
| V514380005 | M6   | V564281001 | M101 | V584004026 | M82  | V584004521 | M82  | V584049002 | M92  |
| V514380005 | M85  | V564281001 | M102 | V584004026 | M88  | V584004521 | M88  | V584049011 | M92  |
| V514380006 | M6   | V564281001 | M17  | V584004026 | M97  | V584004521 | M97  | V584049012 | M92  |
| V514380006 | M85  | V564281001 | M69  | V584004028 | M76  | V584004522 | M76  | V584049101 | M101 |
| V514380007 | M6   | V564281001 | M80  | V584004028 | M82  | V584004522 | M82  | V584049102 | M101 |
| V514380007 | M85  | V564281001 | M92  | V584004028 | M88  | V584004522 | M88  | V584049111 | M101 |
| V514380008 | M6   | V564281002 | M118 | V584004028 | M97  | V584004522 | M97  | V584049112 | M101 |
| V514380008 | M85  | V564281002 | M17  | V584004029 | M76  | V584004524 | M76  | V584049201 | M80  |
| V514380011 | M6   | V564281002 | M36  | V584004029 | M82  | V584004524 | M82  | V584049202 | M80  |
| V514380011 | M85  | V564281005 | M17  | V584004029 | M88  | V584004524 | M88  | V584049211 | M80  |
| V514380012 | M6   | V564281005 | M69  | V584004029 | M97  | V584004524 | M97  | V584049212 | M80  |
| V514380012 | M85  | V564281013 | M101 | V584004030 | M76  | V584004525 | M82  | V584049301 | M102 |
| V514380013 | M6   | V564281013 | M102 | V584004030 | M82  | V584004525 | M88  | V584049302 | M102 |
| V514380013 | M85  | V564281013 | M121 | V584004030 | M88  | V584004526 | M76  | V584049311 | M102 |
| V514380014 | M6   | V564281013 | M17  | V584004030 | M97  | V584004526 | M82  | V584049312 | M102 |
| V514380014 | M85  | V564281013 | M80  | V584004032 | M76  | V584004526 | M88  | V584070100 | M109 |
| V514384543 | M81  | V564281013 | M92  | V584004032 | M82  | V584004526 | M97  | V584070100 | M111 |
| V514384544 | M81  | V564281014 | M107 | V584004032 | M88  | V584004528 | M76  | V584070100 | M113 |
| V562601127 | M14  | V564281014 | M112 | V584004032 | M97  | V584004528 | M82  | V584070300 | M104 |
| V562601127 | M68  | V564281014 | M116 | V584004033 | M74  | V584004528 | M88  | V584070300 | M106 |
| V563600160 | M98  | V564281014 | M118 | V584004033 | M86  | V584004528 | M97  | V584070310 | M113 |
| V563600160 | M100 | V564281014 | M17  | V584004033 | M94  | V584004529 | M82  | V584070310 | M115 |
| V563600160 | M77  | V564281014 | M36  | V584004034 | M74  | V584004529 | M88  | V584070310 | M117 |
|            |      | V564281014 | M73  | V584004034 | M86  | V584004530 | M76  | V584070310 | M72  |



Call the Velvac Sales Team: **800.783.8871** [sales@velvac.com](mailto:sales@velvac.com)

| PART NO.   | PAGE | PART NO.   | PAGE | PART NO.   | PAGE | PART NO.   | PAGE | PART NO.   | PAGE |
|------------|------|------------|------|------------|------|------------|------|------------|------|
| V584070312 | M117 | V584660023 | M99  | V614000010 | M98  | V614270003 | M71  | V614660011 | M79  |
| V584070320 | M113 | V584660023 | M78  | V614000010 | M107 | V614270003 | M9   | V614660011 | M91  |
| V584070330 | M35  | V584660023 | M90  | V614000010 | M112 | V614270004 | M118 | V614720001 | M124 |
| V584070340 | M35  | V584660102 | M99  | V614000010 | M116 | V614270004 | M71  | V614720004 | M124 |
| V584070500 | M115 | V584660102 | M78  | V614000010 | M118 | V614270004 | M9   | V614720004 | M125 |
| V584070500 | M117 | V584660102 | M90  | V614000010 | M121 | V614270005 | M118 | V614720005 | M124 |
| V584070500 | M33  | V584660104 | M99  | V614000010 | M14  | V614270005 | M71  | V614720005 | M125 |
| V584071300 | M120 | V584660104 | M78  | V614000010 | M17  | V614270005 | M9   | V614730023 | M125 |
| V584250541 | M82  | V584660104 | M90  | V614000010 | M33  | V614270006 | M71  | V624059999 | M101 |
| V584250541 | M88  | V584660106 | M99  | V614000010 | M69  | V614270006 | M9   | V624059999 | M102 |
| V584250542 | M82  | V584660106 | M78  | V614000010 | M73  | V614271007 | M107 | V624059999 | M105 |
| V584250542 | M88  | V584660106 | M90  | V614000010 | M77  | V614271007 | M112 | V624059999 | M110 |
| V584250544 | M82  | V584660108 | M99  | V614000010 | M8   | V614271007 | M116 | V624059999 | M114 |
| V584250544 | M88  | V584660108 | M78  | V614000010 | M70  | V614271007 | M118 | V624059999 | M16  |
| V584250554 | M82  | V584660108 | M90  | V614080001 | M48  | V614271007 | M121 | V624059999 | M48  |
| V584250554 | M88  | V584660110 | M99  | V614080002 | M48  | V614271007 | M34  | V624059999 | M53  |
| V584250574 | M82  | V584660110 | M78  | V614090017 | M16  | V614271007 | M71  | V624059999 | M55  |
| V584250574 | M88  | V584660110 | M90  | V614090017 | M54  | V614271007 | M9   | V624059999 | M56  |
| V584660001 | M99  | V584660118 | M99  | V614090018 | M16  | V614280008 | M101 | V624059999 | M57  |
| V584660001 | M78  | V584660118 | M78  | V614090018 | M54  | V614280008 | M102 | V624059999 | M58  |
| V584660001 | M90  | V584660118 | M90  | V614090019 | M16  | V614280008 | M121 | V624059999 | M7   |
| V584660002 | M99  | V584660120 | M99  | V614090019 | M54  | V614280008 | M17  | V624059999 | M75  |
| V584660002 | M78  | V584660120 | M78  | V614090020 | M16  | V614280008 | M69  | V624059999 | M80  |
| V584660002 | M90  | V584660120 | M90  | V614090020 | M54  | V614280008 | M80  | V624059999 | M87  |
| V584660003 | M99  | V593601152 | M103 | V614090021 | M53  | V614280008 | M92  | V624059999 | M92  |
| V584660003 | M78  | V593601152 | M19  | V614090021 | M7   | V614330001 | M56  | V624059999 | M95  |
| V584660003 | M90  | V593601152 | M59  | V614090022 | M53  | V614380005 | M81  | W15        | AC2  |
| V584660004 | M99  | V593601428 | M59  | V614090022 | M7   | V614610002 | M32  | W16        | AC2  |
| V584660004 | M78  | V593603121 | M123 | V614090023 | M53  | V614610003 | M32  | W18        | AC2  |
| V584660004 | M90  | V593605228 | M103 | V614090023 | M7   | V614660001 | M100 | W20        | AC2  |
| V584660005 | M99  | V593605228 | M19  | V614090024 | M53  | V614660001 | M79  | W22        | AC2  |
| V584660005 | M78  | V593605228 | M59  | V614090024 | M7   | V614660001 | M91  | W24        | AC2  |
| V584660005 | M90  | V594121161 | M60  | V614090025 | M53  | V614660002 | M100 | W28        | AC2  |
| V584660006 | M99  | V594121171 | M124 | V614090025 | M7   | V614660002 | M79  | WN14       | AC2  |
| V584660006 | M78  | V594121261 | M60  | V614090026 | M53  | V614660002 | M91  | WN15       | AC2  |
| V584660006 | M90  | V594121461 | M60  | V614090026 | M7   | V614660003 | M100 |            |      |
| V584660007 | M99  | V594450100 | M28  | V614090027 | M53  | V614660003 | M79  |            |      |
| V584660007 | M78  | V594450100 | M60  | V614090027 | M7   | V614660003 | M91  |            |      |
| V584660007 | M90  | V624059999 | M96  | V614090028 | M53  | V614660004 | M100 |            |      |
| V584660008 | M99  | V613600001 | M103 | V614090028 | M7   | V614660004 | M79  |            |      |
| V584660008 | M78  | V613600001 | M19  | V614090029 | M53  | V614660004 | M91  |            |      |
| V584660008 | M90  | V613600001 | M59  | V614090029 | M7   | V614660005 | M100 |            |      |
| V584660009 | M99  | V613600002 | M59  | V614090030 | M53  | V614660005 | M79  |            |      |
| V584660009 | M78  | V613720112 | M123 | V614090030 | M7   | V614660005 | M91  |            |      |
| V584660009 | M90  | V613724110 | M123 | V614090031 | M53  | V614660006 | M100 |            |      |
| V584660010 | M99  | V613846012 | M52  | V614090031 | M7   | V614660006 | M79  |            |      |
| V584660010 | M78  | V613846022 | M52  | V614090032 | M53  | V614660006 | M91  |            |      |
| V584660010 | M90  | V613871900 | M123 | V614090032 | M7   | V614660007 | M100 |            |      |
| V584660017 | M99  | V613871900 | M124 | V614090033 | M53  | V614660007 | M79  |            |      |
| V584660017 | M78  | V613871900 | M125 | V614090033 | M7   | V614660007 | M91  |            |      |
| V584660017 | M90  | V613871900 | M125 | V614090034 | M16  | V614660008 | M100 |            |      |
| V584660018 | M99  | V613871900 | M52  | V614090034 | M54  | V614660008 | M79  |            |      |
| V584660018 | M78  | V613871900 | M53  | V614090035 | M16  | V614660008 | M91  |            |      |
| V584660018 | M90  | V613871900 | M55  | V614090035 | M54  | V614660009 | M100 |            |      |
| V584660019 | M99  | V613871900 | M57  | V614210001 | M6   | V614660009 | M79  |            |      |
| V584660019 | M78  | V613871900 | M58  | V614210001 | M85  | V614660009 | M91  |            |      |
| V584660019 | M90  | V613871998 | M105 | V614250010 | M83  | V614660010 | M100 |            |      |
| V584660020 | M99  | V613871998 | M110 | V614250010 | M89  | V614660010 | M79  |            |      |
| V584660020 | M78  | V613871998 | M114 | V614270002 | M71  | V614660010 | M91  |            |      |
| V584660020 | M90  | V614000010 | M10  | V614270002 | M9   | V614660011 | M100 |            |      |

## PARTS INDEX

**MIRRORS** M

**VISION SYSTEMS** V

**HOSE SUPPORT** H

**AIR PRODUCTS** A

**ELECTRICAL PRODUCTS** E

**FITTINGS & HARDWARE** FH

**FUEL PRODUCTS** F

**BACK-UP CAMERAS** B

**ACCESSORIES** AC

**RETAIL MERCHANDISING** R

### THE VELVAC SECTIONAL CATALOG

To make finding the part you need easier, all products have been numbered sequentially and listed with their sectional page reference number. For the most up-to-date listing of products, please visit our online catalog at: [velvac.com](http://velvac.com)



- Founded in 1934
- TS 16949 & ISO 14001



New Berlin headquarters



Reynosa facility



Call the Velvac Sales Team: **800.783.8871** [sales@velvac.com](mailto:sales@velvac.com)

© VELVAC INC. • 2405 South Calhoun Road • New Berlin, WI 53151-2709 • Toll Free: 800.783.8871 • Fax: 262.786.4101

4500+ AFTERMARKET PARTS



We've got  
what you're  
looking for.



800.783.8871

There are over 4,500 **Velvac Aftermarket** products in this catalog. From Fleet to Bus, Motorhome to Specialty Vehicle, our customer service team is ready to ship out your order accurately and on-time! *We're open for your business!*



**VELVAC**  
In the Passing Lane Since 1934

velvac.com

## NEW PRODUCTS

### MIRRORS

**LANEOPTICS  
MIRRORCAM  
PAGE M26**



### VISION SYSTEMS



**SHORT ARM AEROCAM  
AEROCAM POST CAM  
PAGE V4**



### HOSE SUPPORT

**1/2" HOSE SEPARATOR  
PAGE H2**



**REPLACEMENT  
3-IN-1 CLAMP  
PAGE H3**



Call the Velvac Sales Team: **800.783.8871** [sales@velvac.com](mailto:sales@velvac.com)

## NEW PRODUCTS

**RAPID LIFT AXLE CONTROL VALVE**  
PAGE A33



### AIR PRODUCTS

**3/8" DRAIN COCK**  
PAGE A26



### ELECTRICAL PRODUCTS

**SPIRAL WRAP**  
PAGE A32



**VERTICAL DUAL PLUG, SOCKET & CABLE**  
PAGES E2, E4, E6



### FUEL PRODUCTS

### FITTINGS & HARDWARE

**45° MALE SWIVEL ELBOW**  
PAGE FH4

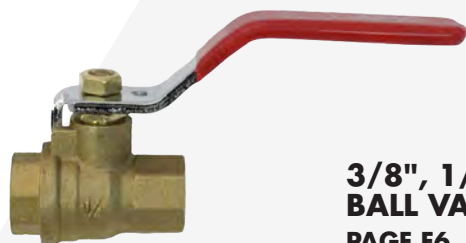

**3/8", 1/4" BALL VALVES**  
PAGE F6

